

BIESSE STREAM A

Automatic single-sided edgebanding machines

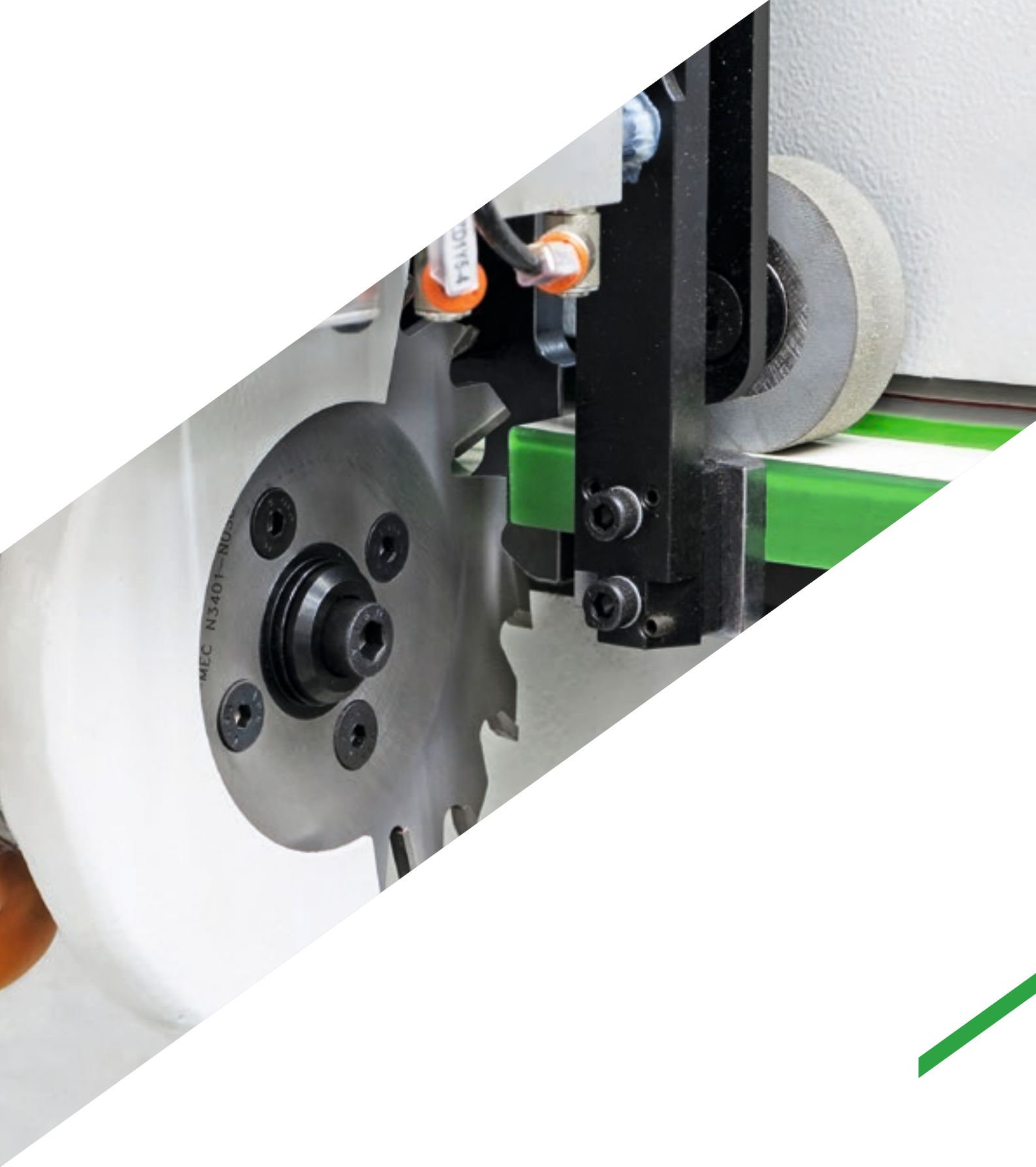

When competitiveness
means reliability across
several work shifts

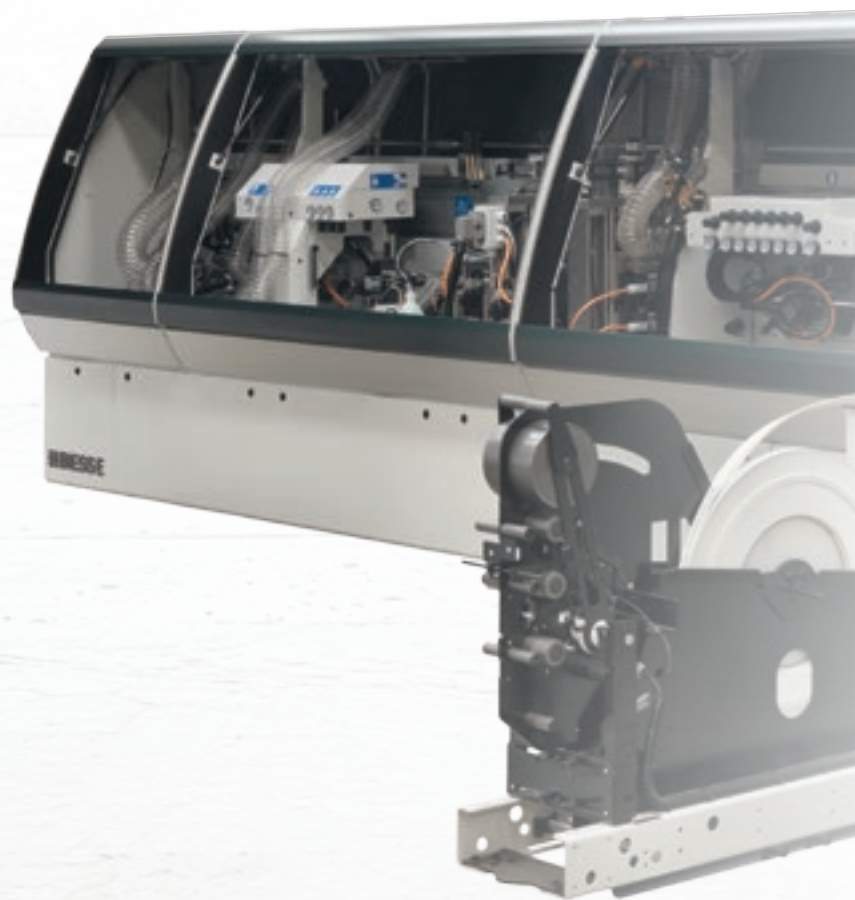

Made **In** Biesse

The market demands

a change in manufacturing processes, enabling companies **to accept the largest possible number of orders**. This is coupled with the need to maintain high quality standards whilst offering product customisation with quick and defined delivery times, as well as responding to the needs of highly creative designers.

Biesse meets these requirements

with technological solutions that enhance and support technical expertise, as well as process and material knowledge. **Stream A** is the new range of automated single-sided edgebanding machines aimed at craftspeople and small enterprises who wish to increase their production capacity. It enables users to ramp up production up to 2 work shifts. It seamlessly adapt to any machining needs thanks to its configuration possibilities.

- ✓ **The precision of an industrial machine thanks to the sturdy structure.**
- ✓ **Machine customisation depending on production requirements.**
- ✓ **Advanced technology for a perfect finish.**
- ✓ **Top quality finished product.**

Tailor-made edgebanding



 **BIESSE STREAM A**

Automatic single-sided edgebanding machines



The precision of an industrial machine

The sturdy structure guarantees the precision and reliability typical of production-line machines.



The **monolithic base** provides high stability and allows the machine to operate also over several work shifts whilst continuing to deliver high quality standards.



The sturdy 25 mm **columns**, fixed directly on the base, fully absorb all vibrations generated during machining.

Machine customisation depending on production requirements

Many units available to configure the machine based on machining requirements.

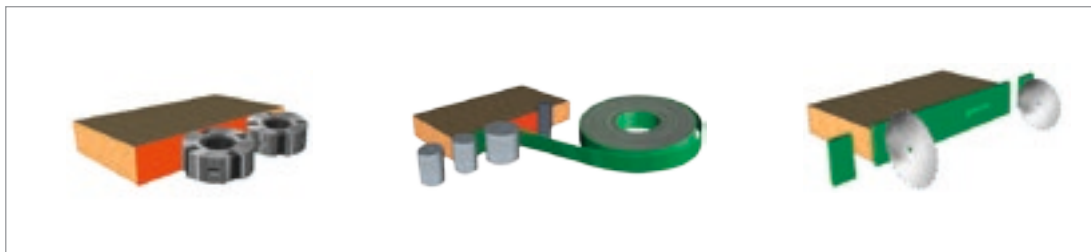

Pre-milling unit.

Gluing unit.

End trimmer:
2 versions available.



Rough trimmer.

Fine trimmer:
2 versions available.

Corner rounding unit:
2 versions available.



Edge scraper:
3 versions available.

Glue scraper.

Grooving unit.



Buffing unit.

Hot air blower.

Sanding unit.

Mass customisation

18 working units available, which can be combined and, in some cases, repeated, to obtain high-quality, customised products. Thanks to the advanced technology of some units, it is possible to manage endless machining positions; the machine adapts to the process being executed based on the edge's thickness and material.

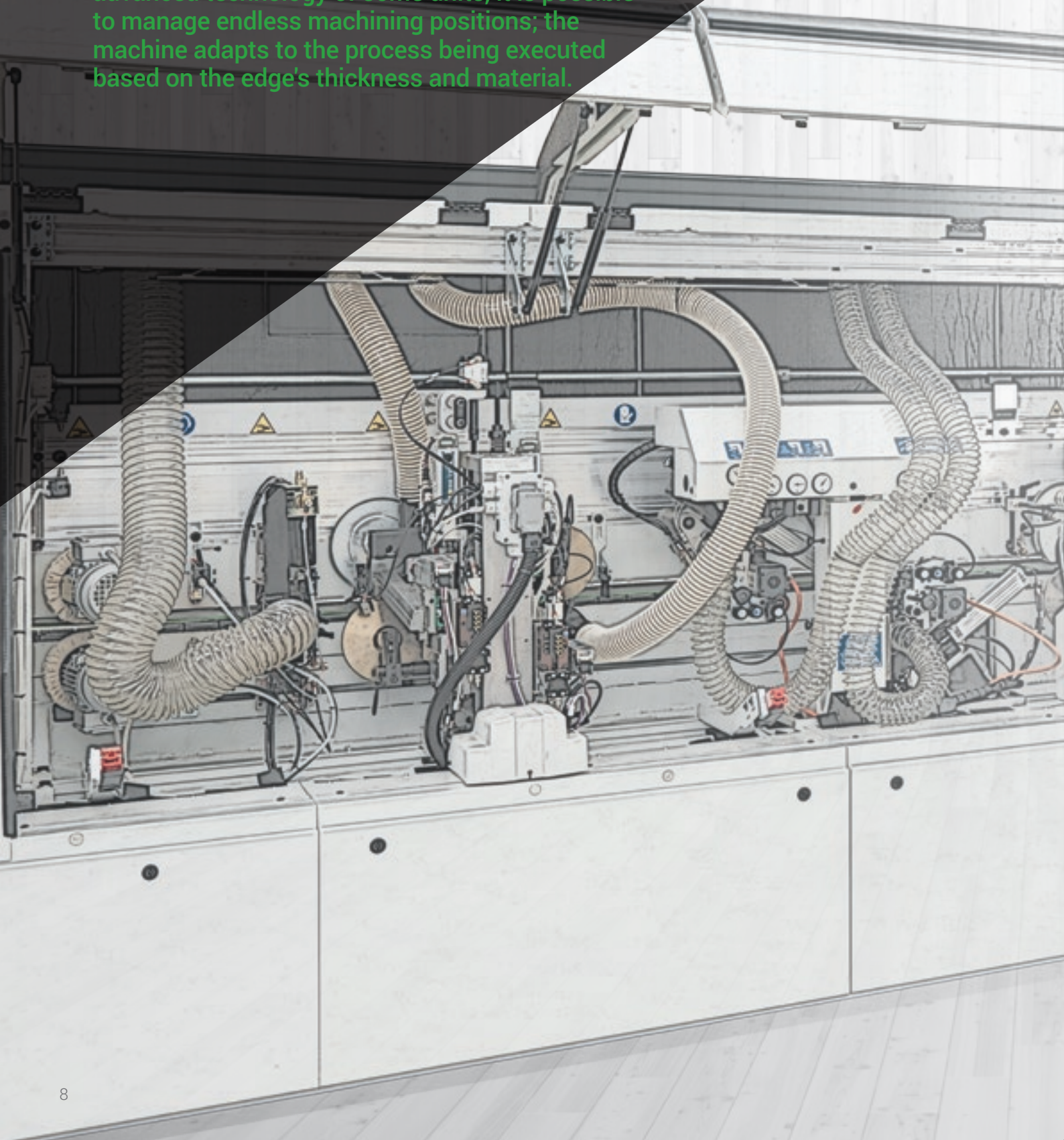

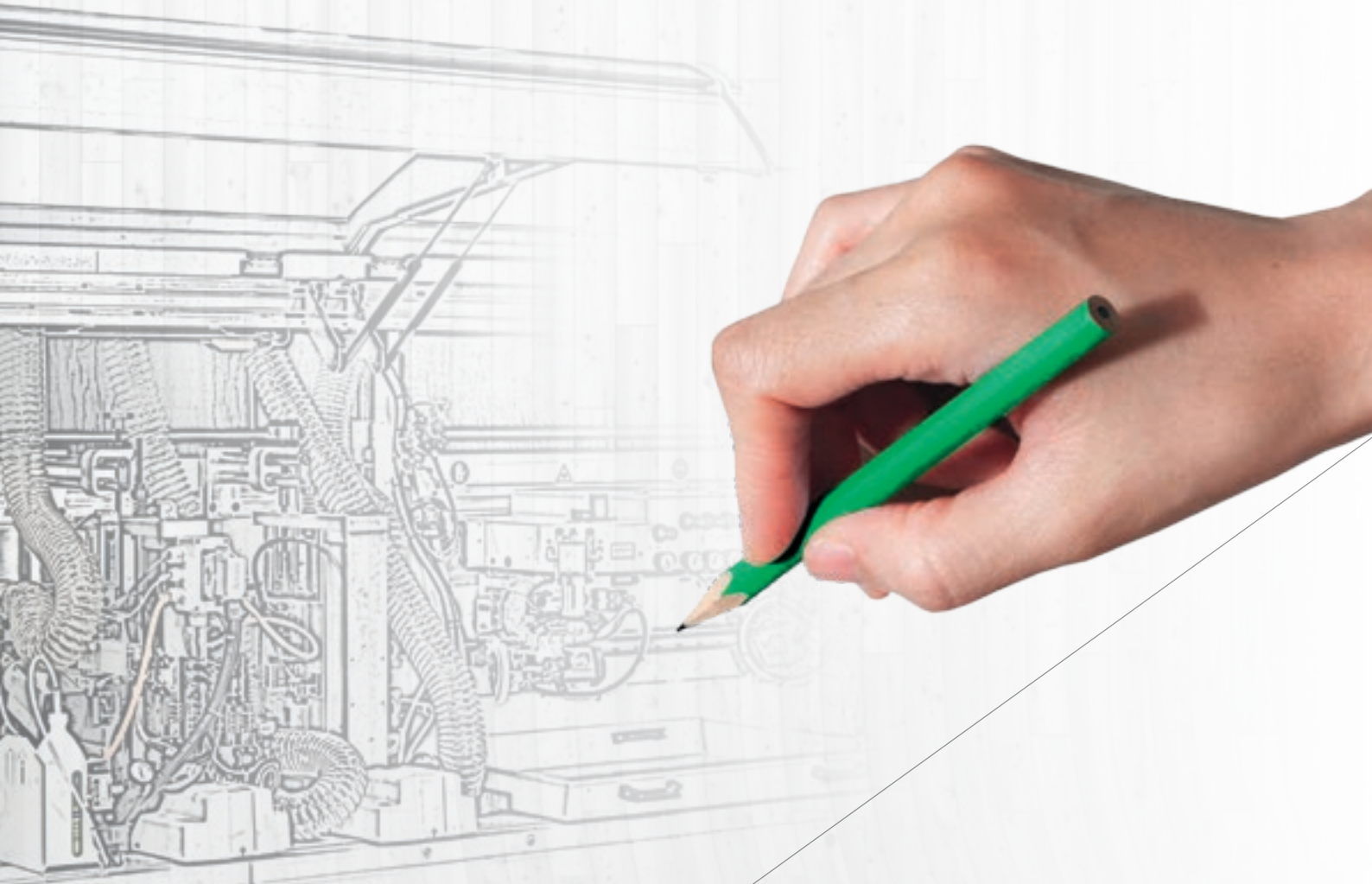

STREAM CONFIGURATIONS

Over 2.5 billion possible configurations to meet any processing needs. A perfect combination of Biesse technology and Italian genius.

Quality edgebanding

High-tech solutions created to guarantee
high quality standards.



The 2-motor **Pre-milling Unit** with automatic intervention guarantees a perfect base for glueing.

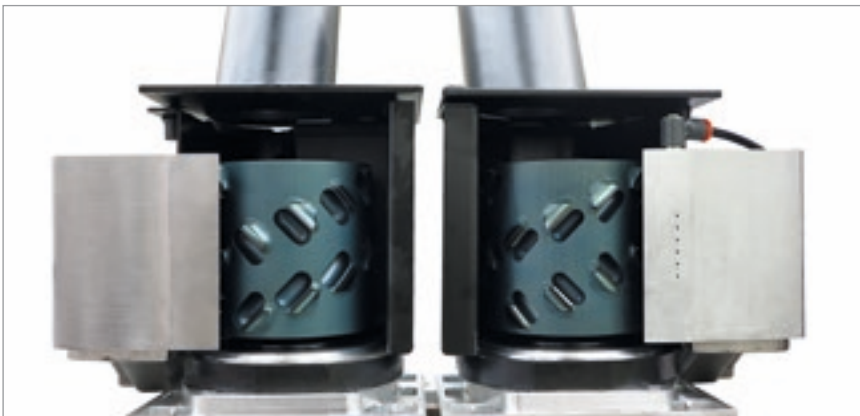

The **Pre-milling Autoset** device for the automatic centring of the tool on the panel improves quality whilst reducing set-up times.

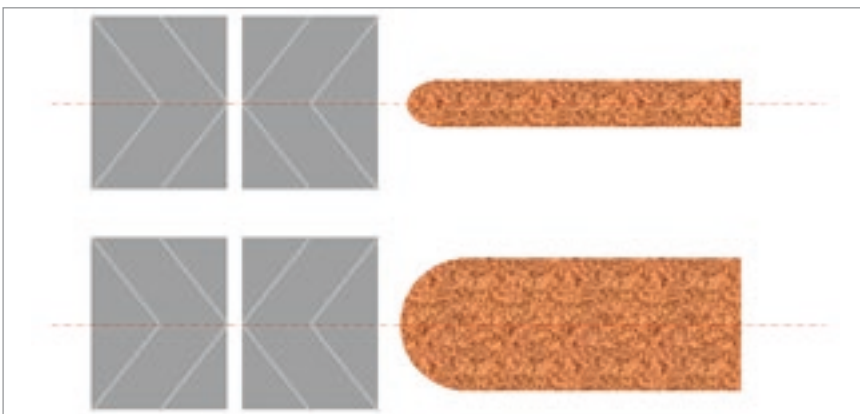



Gluing unit for the automatic application of edging in rolls or strips, from 0.4 to 12mm. Developed as standard equipment for all technologies for maximum performance.

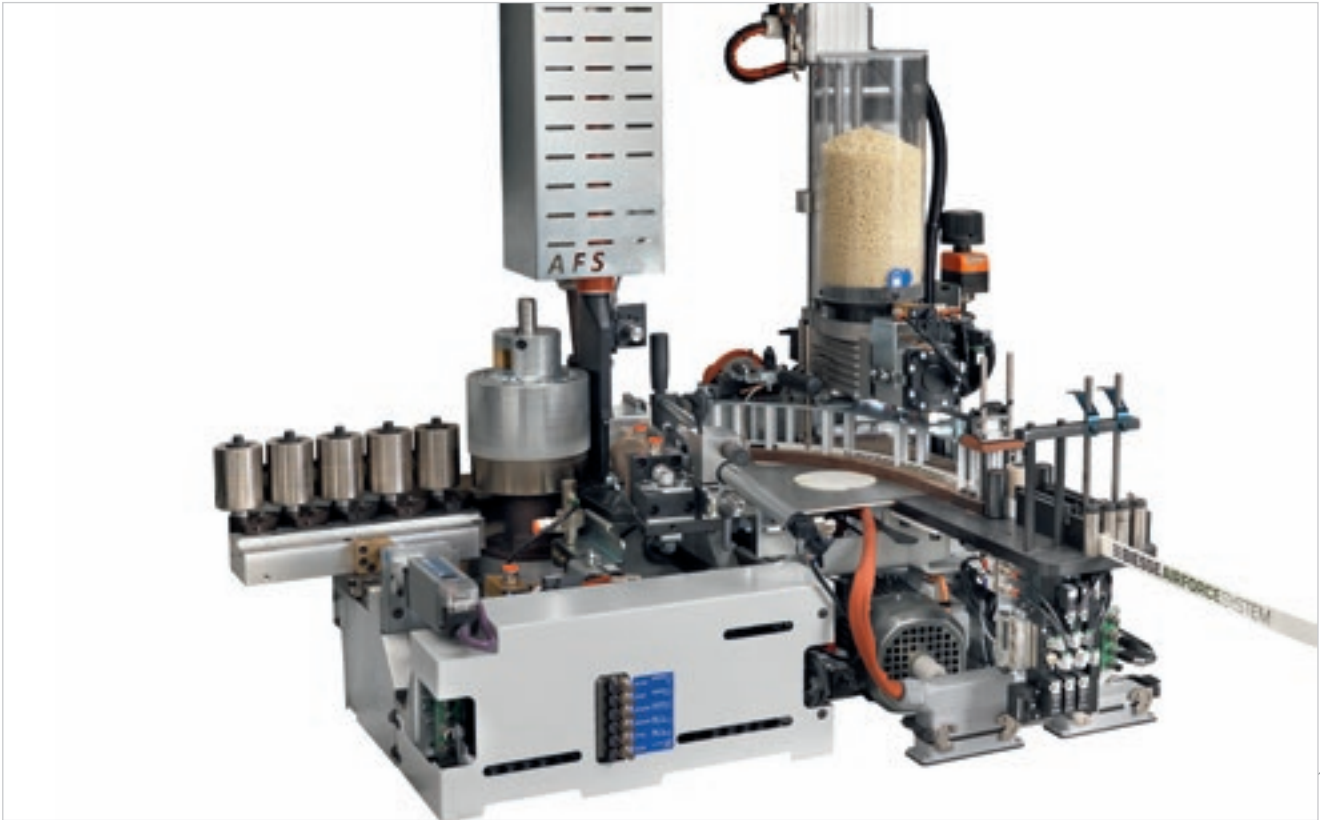

Advanced management of PU glue depending on machining requirements.



Reduction of machine set-up time thanks to the **2-position magazine** for automatic edge replacement in real time.

Invisible Edgebanding



Air Force System, available on Biesse edgebanding machines, is based on the physical principle of convection. By using a compressed hot air system, the edge bonds perfectly with the panel, guaranteeing resistance to water and heat and an excellent long-lasting quality finish.

AIR FORCE SYSTEM

No joints and no glue line, in perfect harmony with the panel. A perfect combination of Biesse quality and Italian genius.



Maximum visibility of machining operation

A specific Research & Development team creates pioneering solutions to meet market requirements and offer cutting edge technology that is reliable and guarantees first-class results.

Cutting quality and precision thanks to the **End Trimmer** that supports the trimming of the panel edge at both ends. 2 versions available depending on machining requirements.



IN801



The IN801 unit includes, as standards:

- ✓ the dynamic suctioning system that follows the blades' every move,
- ✓ automatic blade tilting,
- ✓ copying system suitable for processing hinge holes.



IT90S
Linear end trimmer for high speeds.



The copying and tracing system guarantees optimal finish quality also on high-gloss edges with film.

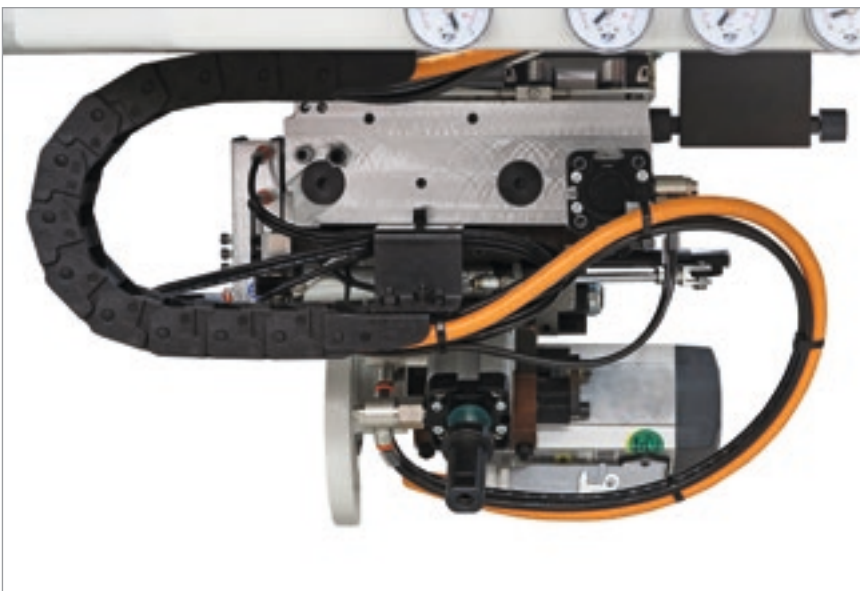

The machine movement on its axis, on linear tracks, allows the achievement of very high processing speeds.

Reduced production time

Stream A offers personalised solutions that enable a reduction of set-up and machining times.

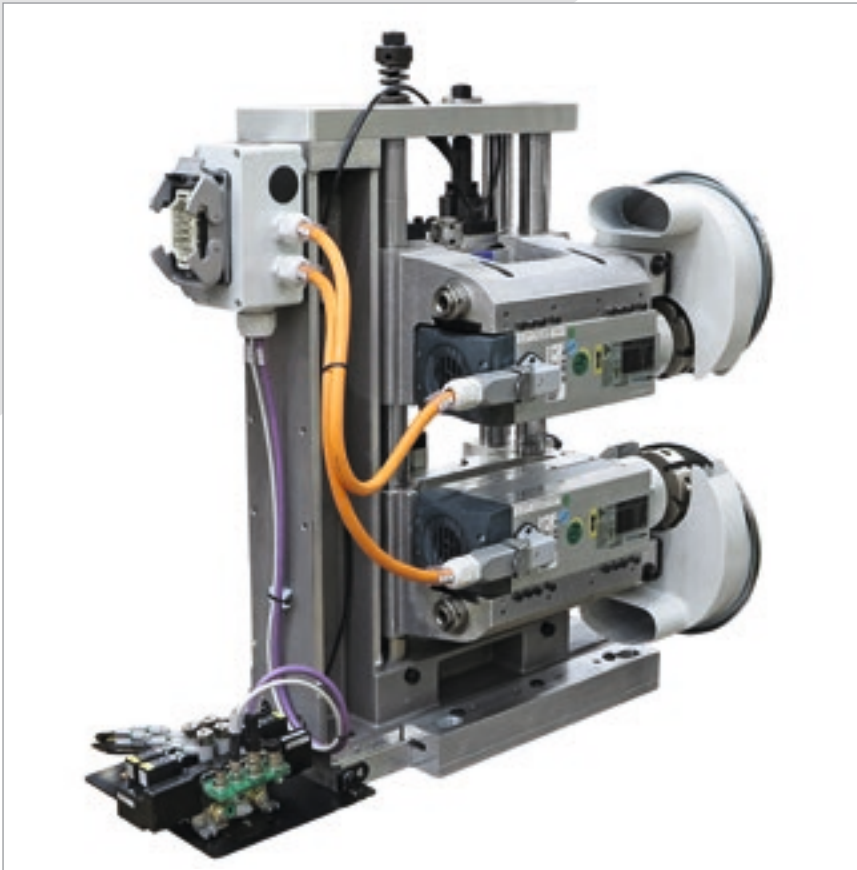

The **Rough Trimmer** reduces the excess edge on the top and bottom of the panel. It guarantees a perfect finish for solid wood, in one single movement.

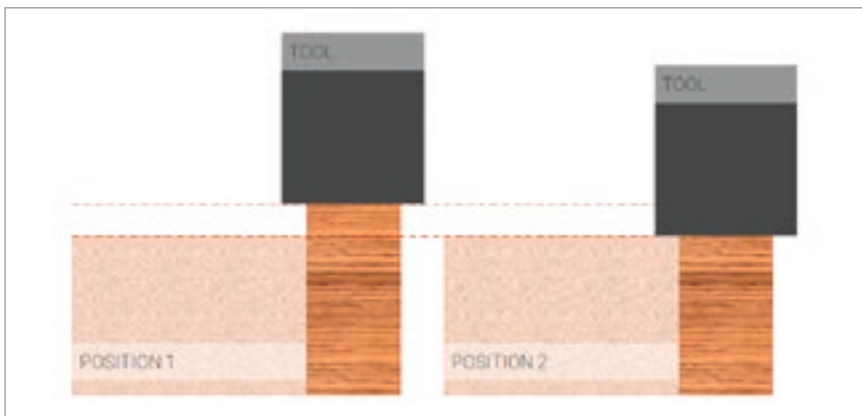

Duo System is a device for the automatic changeover between the rough-shaping and finishing functions.

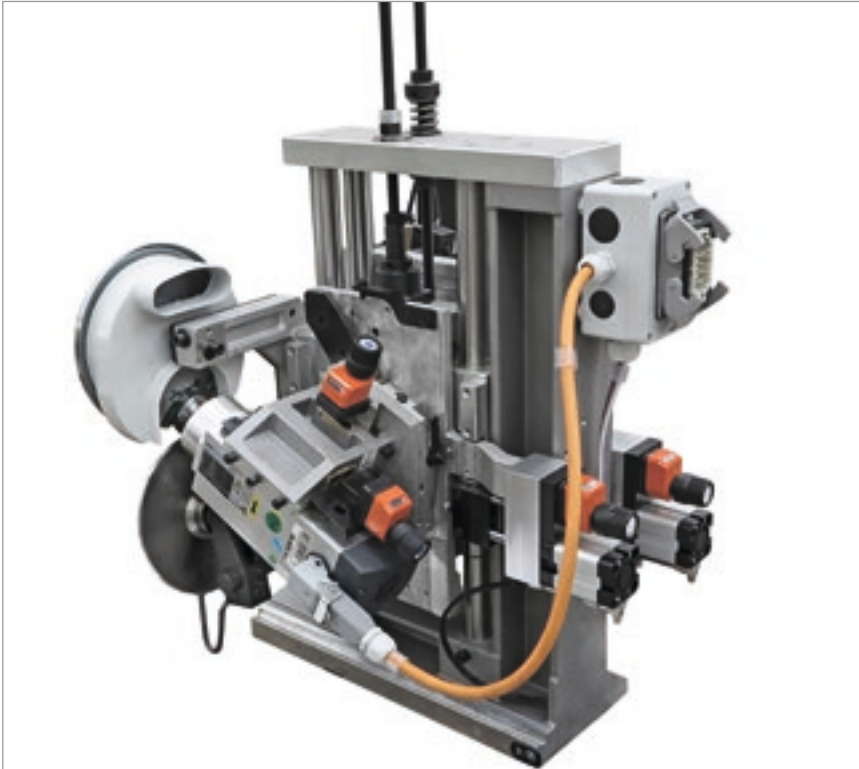

The **Fine trimmer**, for fine trimming of the top and bottom edges. Complete with 2 high-frequency motors and vertical/horizontal copiers with rotating disc.



RF100

The ideal unit for standardised production that enables maximum machining quality.



RF300

Manual management of machining settings with 4 automatic tool profile settings. Greater setting speed to move from one machining operation to the other.



RF400

Full machining setting autonomy. The ideal solution for users who require absolute machining flexibility, thanks to the full adjustment of the machine to the required edge thickness.

Unique technology on the market

Unique innovations in this machine price range to meet productivity and flexibility requirements of the most demanding manufacturers.

The multi-function **Corner Rounding Unit** forms a radius on both the front/rear and top/bottom edges.



AR30NC

Equipped with two engines for standard machining operations.



AR34NC

Equipped with four engines to process even different materials such as rounded wood edges.

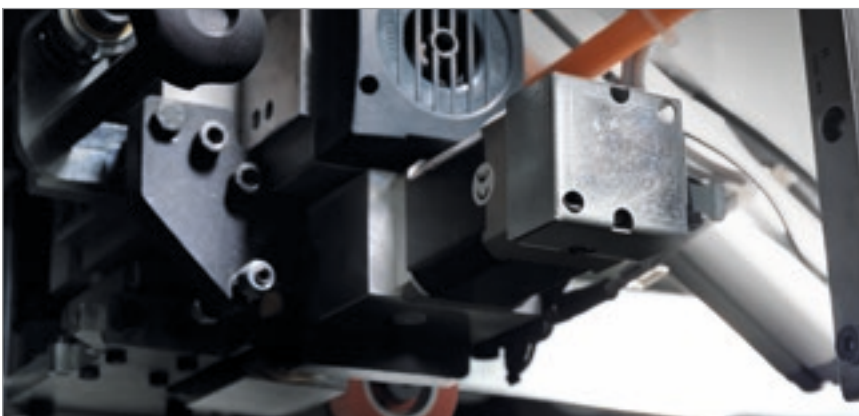

The controlled axis, fitted as standard on both version of the Corner Rounding unit, supports the management of infinite machining settings. The machine is perfectly suited to manufacturing needs.



The **Edge scraper** eliminates the imperfections resulting from previous machining operations on the top and bottom of the edge.



RB02

Compact working with the management of 2 controlled-axis profiles for infinite settings.



RB300

Positioned on the column, it allows the management of four automatic blade settings

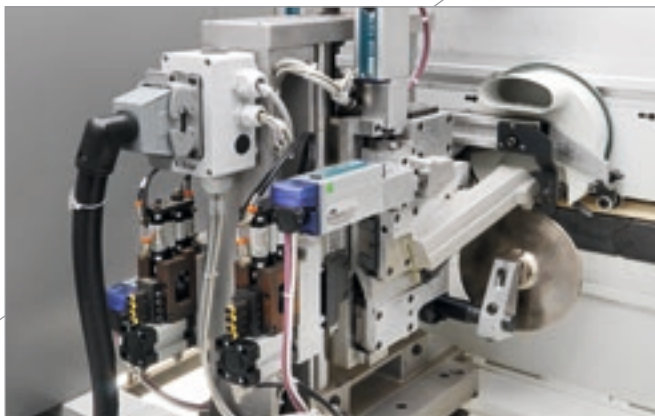

RB400

Positioned on the column for the complete absorption of any vibration generated on the structure, with the management of 2 controlled-axis profiles for infinite settings.

High-quality products

High-tech solutions designed for the perfect finish of any type of machining operation.



The **Glue Scraper** removes excess glue from the top and bottom of the panel. This is the only model on the market fitted with 4 pneumatic cylinders for a top quality finish.

The **Grooving Unit** supports the performance of grooves and milling on the bottom surface of the panel.





Sanding Unit to sand wood edges.



Hot air blower for reactivating the colour of the edges.



Buffing unit to clean and polish the edge and the panel.

Technology at the user's service

Immediate, user-friendly programming thanks to the touch-screen control panel.



Edgebanding machine management
100% touch with no need for external devices.

Maximum usability thanks to the 21.5" Full HD screen, which guarantees optimal visibility.

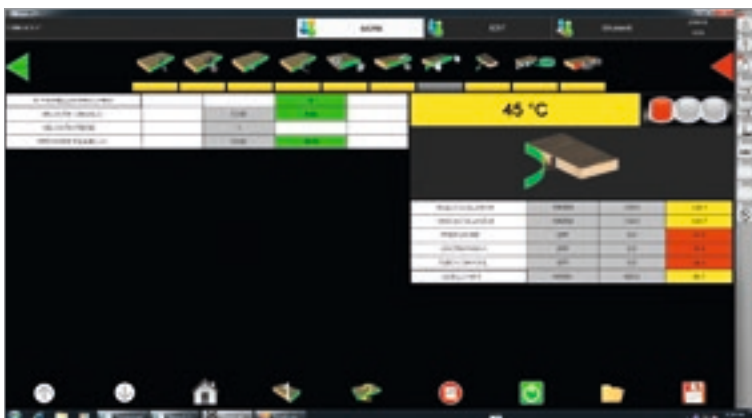

✓ Easy programme management and usability.

✓ Rapid transition from one machining operation to the next.

✓ Intelligent language management.



Technical specifications



	L
Stream A/5.0	mm 6450 - inch 253.9
Stream A/6.0	mm 7450 - inch 293.3
Stream A/6.5	mm 7950 - inch 312.9

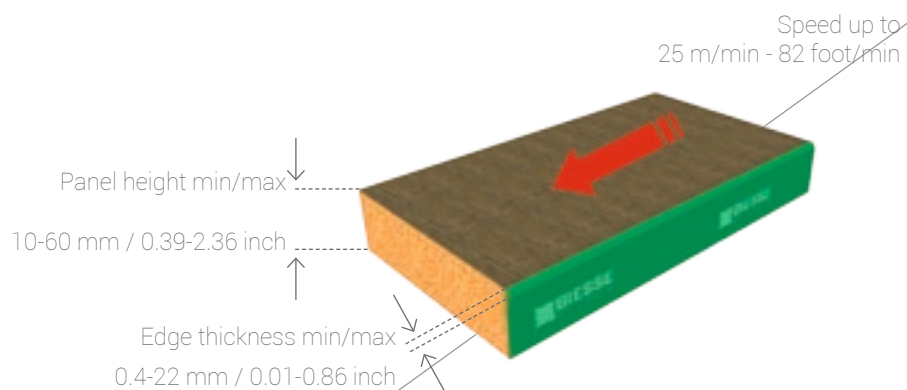

The technical specifications and drawings are non-binding. Some photos may show machines equipped with optional features. Biesse Spa reserves the right to carry out modifications without prior notice.

A weighted sound pressure level (LpA) during machining for operator workstation on vane-pump machine Lpa=79dB(A) Lwa=96dB(A) A-weighted sound-pressure level (LpA) for operator workstation and sound power level (LwA) during machining on cam-pump machine Lwa=83dB(A) Lwa=100dB(A) K measurement uncertainty dB(A) 4

The measurement was carried out in compliance with UNI EN 848-3:2007, UNI EN ISO 3746: 2009 (sound power) and UNI EN ISO 11202: 2009 (sound pressure levels at workstation) during panel machining. The noise levels shown are emission levels and do not necessarily correspond to safe operation levels. Despite the fact that there is a relationship between emission and exposure levels, this may not be used in a reliable manner to establish whether further measures need to be taken. The factors determining the exposure level for the workforce include length of exposure, work environment characteristics, other sources of dust and noise, etc. i.e. the number of other adjoining machines and processes. At any rate, the above information will enable the operator to better evaluate dangers and risks.

Service & Parts

Direct, seamless co-ordination of service requests between Service and Parts. Support for Key Customers by dedicated Biesse personnel, either in-house and/or at the customer's site.

Biesse Service

- ✓ Machine and system installation and commissioning.
- ✓ Training centre dedicated to Biesse Field engineers, subsidiary and dealer personnel; client training directly at client's site.
- ✓ Overhaul, upgrade, repair and maintenance.
- ✓ Remote troubleshooting and diagnostics.
- ✓ Software upgrade.

500 / Biesse Field engineers in Italy and worldwide.

50 / Biesse engineers manning a Teleservice Centre.

550 / Certified Dealer engineers.

120 / Training courses in a variety of languages every year.

The Biesse Group promotes, nurtures and develops close and constructive relationships with customers in order to better understand their needs and improve its products and after-sales service through two dedicated areas: Biesse Service and Biesse Parts.

With its global network and highly specialised team, it offers technical service and machine/component spares anywhere in the world on-site and 24/7 on-line.



Biesse Parts

- ✓ Original Biesse spares and spare kits customised for different machine models.
- ✓ Spare part identification support.
- ✓ Offices of DHL, UPS and GLS logistics partners located within the Biesse spare part warehouse, with multiple daily pick-ups.
- ✓ Order fulfilment time optimised thanks to a global distribution network with de-localised, automated warehouses.

87% / of downtime machine orders fulfilled within 24 hours.

95% / of orders delivered in full on time.

100 / spare part staff in Italy and worldwide.

500 / orders processed every day.

Made **With** Biesse

A new edgebanding system to ensure quality.

Closet America, a leading home and professional closet system manufacturer headquartered in Lanham, Maryland, is proud to be the first company in the United States to incorporate the Biesse AirForce edgebanding system into its production line. "In our efforts to provide our customers with a high-quality, customised closet system along with our top-notch customer service, we were excited to invest in the Biesse AirForce system. Closet America is known for our quality closet design, our superior

product and expert installation. Our investment in the AirForce system, coupled with the use of Rehau's LaserEdge edgebanding material, is another step towards continuously exceeding our customers' expectations". The AirForce system enables companies to exploit the sustainability benefits provided by the excellent range of laser edgebands with invisible glue line. AirForce emits compressed air at a very high temperature from a special nozzle directly onto the reactive layer of the laser edgeband,

thus activating the layer and welding the edgeband to the substrate. Installing the new Stream A together with AirForceSystem will result in a product of an exceptional quality, apart from contributing to increasing manufacturing speed".

Skip Labela
President of Closet America



Biesse Group

In

1 industrial group, 4 divisions.
and 8 manufacturing sites.

How

€ 14 million p/a in R&D and 200 patents registered.

Where

33 branches and 300 agents/certified dealers.

With

customers in 120 countries, manufacturers of furniture, design items and door/window frames, producers of elements for the building, nautical and aerospace industries.

We

3000 employees worldwide.

Biesse Group is a global leader in the technology for processing wood, glass, stone, plastic and metal.

Founded in Pesaro in 1969, by Giancarlo Selci, the company has been listed on the Stock Exchange (STAR segment) since June 2001.

 **BIESSEGROUP**

 **BIESSE**

 **INTERMAC**

 **DIAMUT**

MECHATRONICS

