

Fravol

woodworking machines

FAST

F series

F PLUS series



fravol.it

FAST F 600-23



Frevol

◀ style & technology

inside ▶

IT Macchina Bordatrice

- Macchina Bordatrice automatica per l'applicazione di bordi in PVC, ABS, melaminico, impiallacciatura, masselli, in strisce o rotolo.
- Macchina compatta e robusta.
- Ideale per l'industria e l'artigianato.
- Avanzamento 10 mt/min.
- FAST PLUS 12-16 mt/min.
- Rapida nel riscaldamento; la partenza avviene in 6 ÷ 8 minuti.
- Capacità della vasca colla: Kg 1. - Quick release optional.
- Gruppi regolati automaticamente con barra pressore avente una doppia fila di ruote.

- Un motore del gruppo di taglio, con due lame e inclinazione automatica a 3°; alimentato da inverter ad alta frequenza a 200 Hz.

EN Edge-Banding Machine

- Single automatic edging machine for application of PVC, ABS, melamine, veneer and solid wood edges in strips or rolls.
- Compact sturdy machine.
- Ideal for industrial or artisan use.
- Adjustable 10 mt/minutes.
- FAST PLUS 12-16 mt/min.
- Quick heating, start-up 6 ÷ 8 minutes.
- Glue pot capacity: Kg. 1. - Quick release optional.
- The units are adjusted automatically with pressure bar provided with a double row of wheels.

- One motor trimming unit, with two blade and automatic tilting to 3°; Powered from inverter at high frequency 200 Hz.

FR Encolleuse de Chants

- Machine Encolleuse automatique pour l'application de chants en PVC, ABS, mélaminé, plaqué, massif, en bande ou rouleau.
- Machine compacte et robuste.
- Idéale pour l'industrie et l'artisanat.
- Avancement 10 mt/min.
- FAST PLUS 12-16 mt/min.
- Rapide dans l'échauffement, la partie arrive en 6 ÷ 8 minutes.
- Capacité du bac à colle: 1 Kg. - Quick release optional.
- Groupes presseurs réglable automatiquement composé de deux rangées de roulettes.

- One moteur coupe en bout avec deux lame et inclinaison automatique ou 3°; alimentateur du inverter à haute fréquence 200 Hz.

DE Kantenanleimmaschine

- Automatische Kantenanleimmaschine für das Anleimen und Nachbearbeiten von PVC-ABS-Melamin- und Furnierkanten als Streifen- oder Rollenware und Massivholzkanten.
- Kompakte und stabile Maschinenbauweise.
- Der ideale Automat für den Industriebetrieb und die Möbelwerkstätte.
- Vorschubgeschwindigkeit stufenlos bis 10 mt/Min.
- FAST PLUS 12-16 mt/min.
- Schnellheizbecken, Aufheizzeit max. 6 ÷ 8 Minuten.
- Leimbeckeninhalt ca. 1 Kg. - Quick release optional.
- Oberdruckwerk mit doppelter Reihe von Druckrollen, gleichzeitig Höhenverstellung der oberen Nachbearbeitungsaggregate mit dem Oberdruckwerk.
- Ein motorisiertes Kappsägeaggregat, mit 2 Sägeblättern, automatisch schwenkbar zwischen 3°. Betrieben an einem Umrichter mit 200Hz.

ES Encoladora de Canto

- Máquina automática para el encolado de cantos en PVC, ABS, melamina, madera, en tiras o rollos.
- Máquina compacta y robusta.
- Ideal para la industria y el pequeño taller.
- Avance 10 mt/min.
- FAST PLUS 12-16 mt/min.
- Calentamiento rápido de 6 ÷ 8 minutos.
- Capacidad del depósito de cola: 1 Kgs. - Quick release optional.
- Grupos regulados automáticamente con barra prensora con doble fila de ruedas.

- Retestador mono-motor, con dos sierras y inclinación automática 3°; alimentador con inverter alta frecuencia 200 Hz.

Frevol

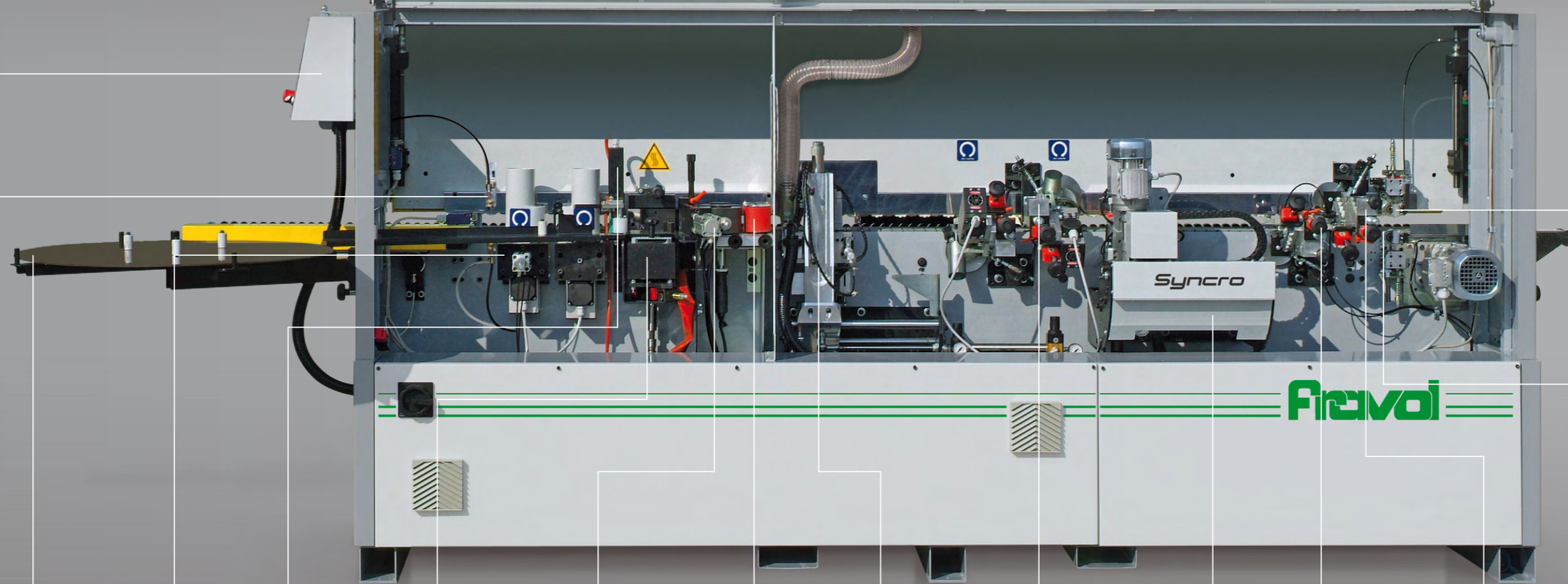

configuration

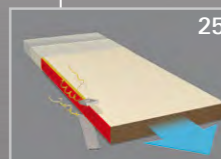
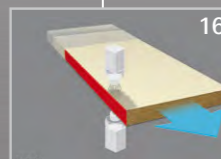
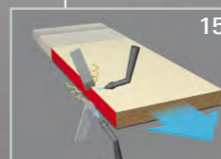
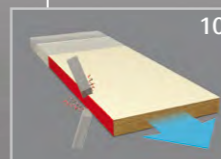
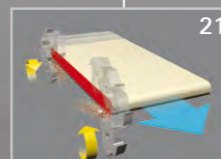
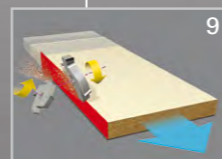
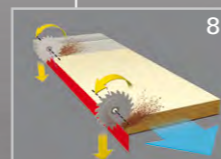
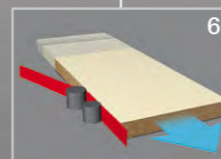
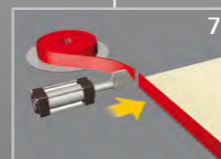
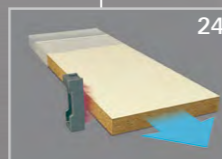
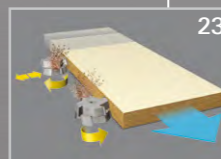
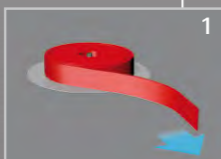
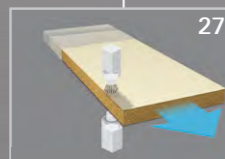



F200-23

F400-23



F600-23

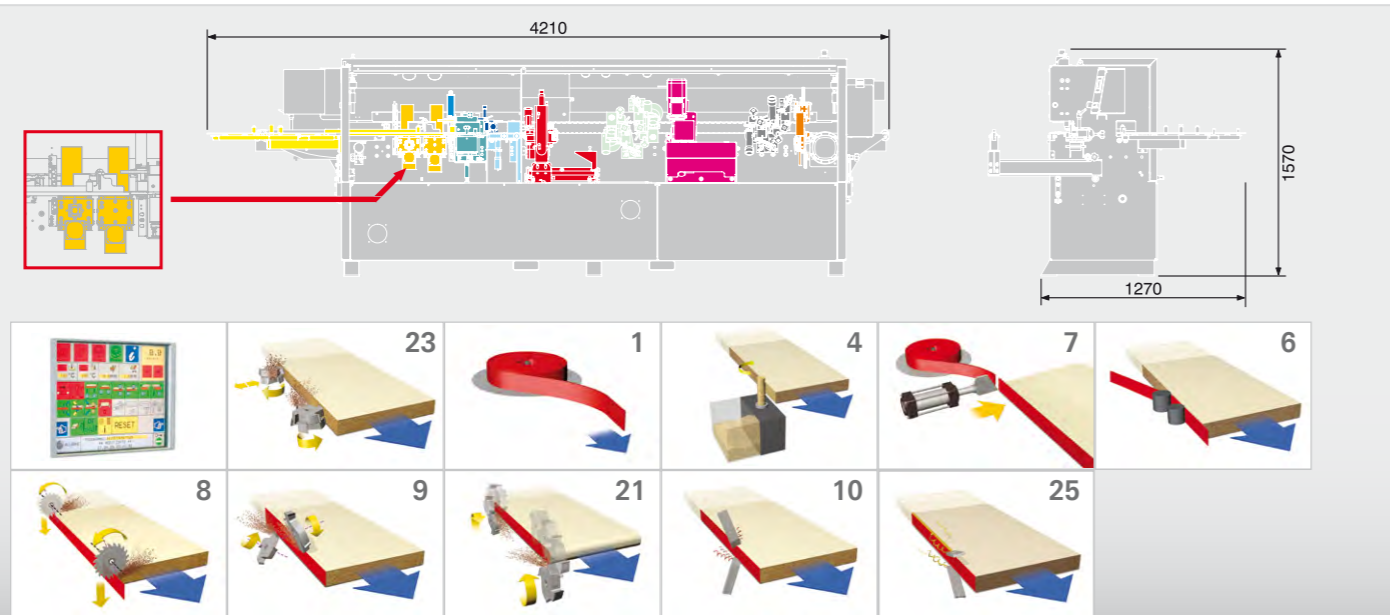

F650-23 PLUS

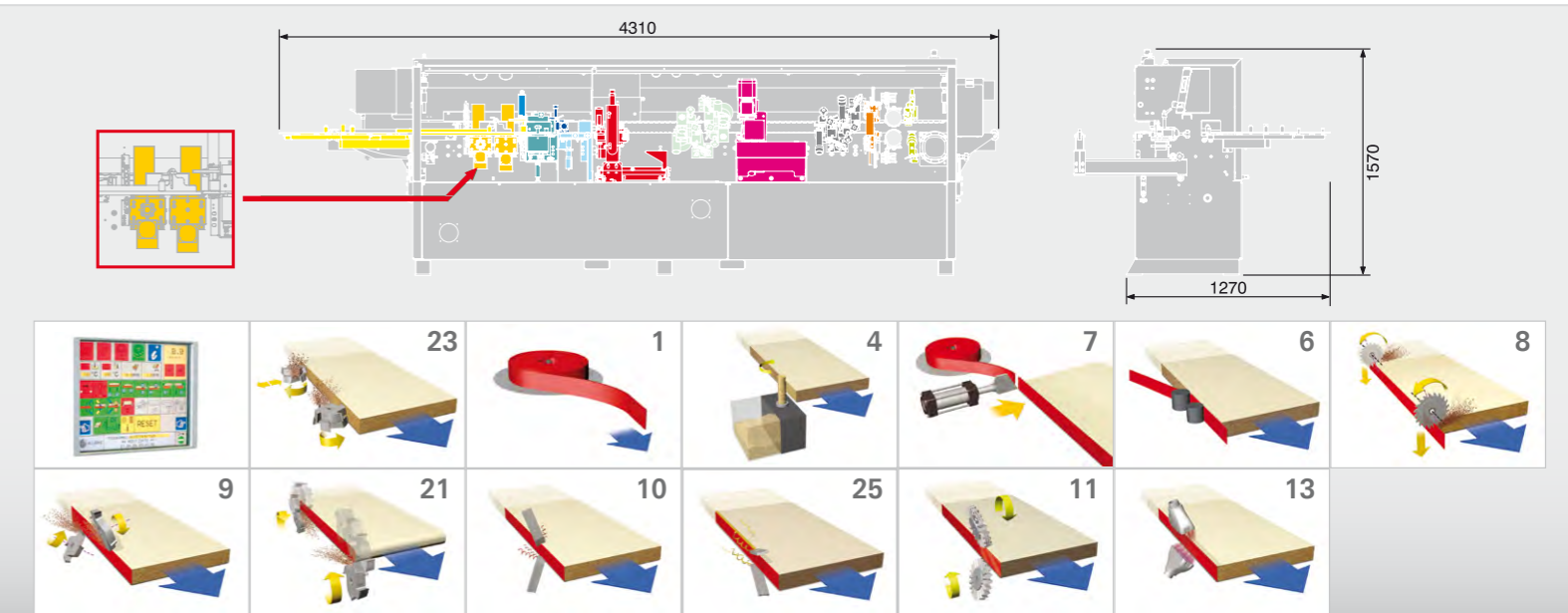



Touch Screen
8.4" Colour



- IT Controllo con microprocessore (P.L.C.)
- EN Microprocessor control (P.L.C.)
- FR Contrôle avec microprocesseur (P.L.C.)
- DE Mikroprozessor-Steuerung (S.P.S.)
- ES Control con microprocessador (P.L.C.)



Touch Screen
12" Colour



- IT Controllo con microprocessore (P.L.C.)
- EN Microprocessor control (P.L.C.)
- FR Contrôle avec microprocesseur (P.L.C.)
- DE Mikroprozessor-Steuerung (S.P.S.)
- ES Control con microprocessador (P.L.C.)



24 0 - 600°C
250 Watt

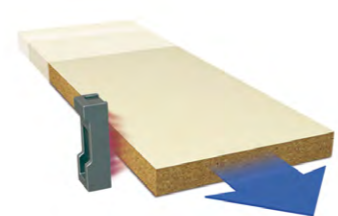

- IT Lampada IR
- EN IR Lamp
- FR Lampe IR
- DE IR Lampe
- ES Lámpara IR



30 1,0 Kg

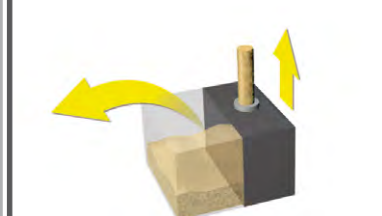

- IT Vasca colla con sgancio rapido
- EN Glue tank with quick release
- FR Bac a' colle avec system de changement rapid
- DE Leimbecken mit schnellverschluss-system
- ES Calderin de cola con desenganche rapido



27

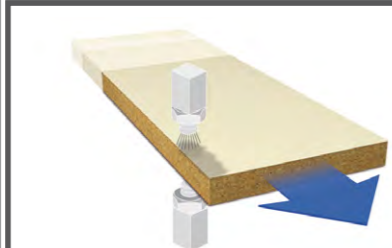

LIQUID PROTECTIVE

- IT Sistema di spruzzatura dell'agente distaccante
- EN Release agent spraying system
- FR Système de pulvérisation d'agent de démoulage
- DE Trennmittel-Sprühsystem
- ES Sistema de spray del agente antiadherente



23

0,75+1,1 Kw
12.000 rpm

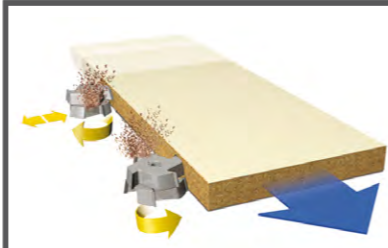

- IT Toupie in entrata
- EN Pre-Milling Unit
- FR Toupie en entrée
- DE Füge-Fräsggregat am Maschinenleinlauf
- ES Toupie en entrada



14

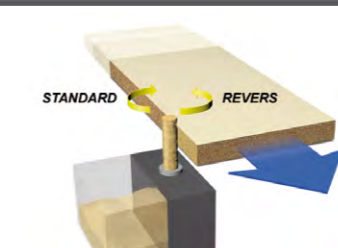

- IT Vasca colla con reverse
- EN Auto-reverse glue tank
- FR Bac a colle auto-reverse
- DE Reverse (Doppel-Rotationssinn)
- ES Deposito cola auto-reverse



6

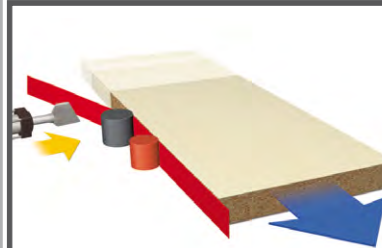

- IT Rulli pressore
- EN Pressure rollers
- FR Rouleau presseur
- DE Andruckrollen
- ES Rodillos de presion

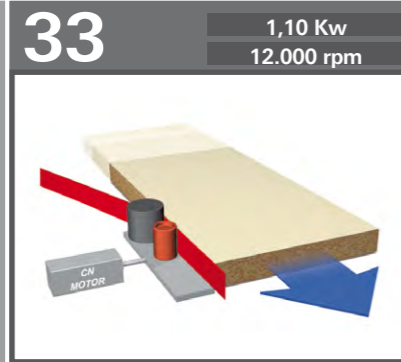
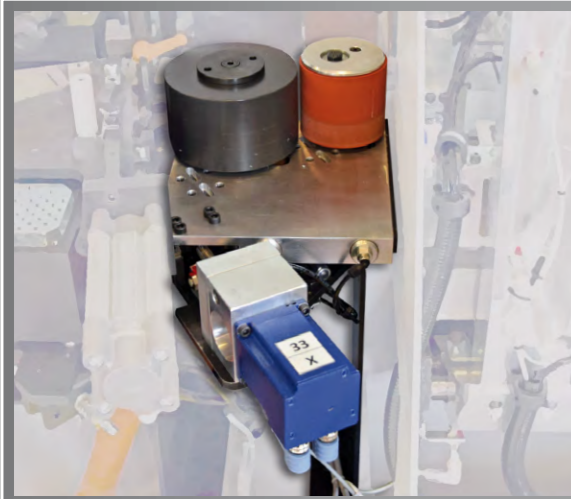

33 1,10 Kw
12.000 rpm

IT Rulli pressori con controllo CN
EN NC-positioning of the pressure roller unit
FR Positionnement a CN du presseur superieur
DE NC-gesteuerte Druckrollen
ES Posicionamiento a cn del grupo rodillos prensores

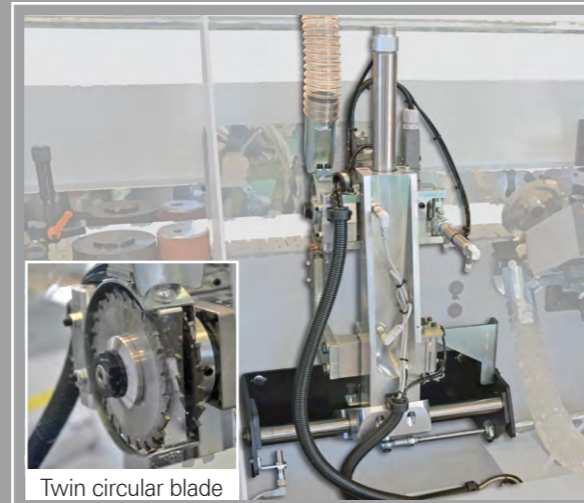

Twin circular blade

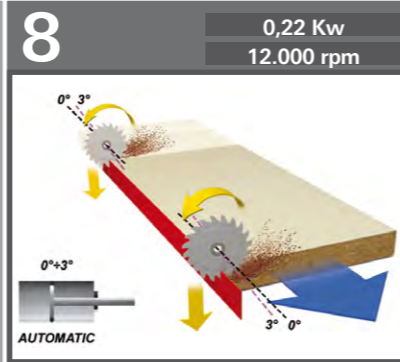

8 0,22 Kw
12.000 rpm

IT Intestatore
EN End-Trimming
FR Abouters
DE Kappen
ES Retestador

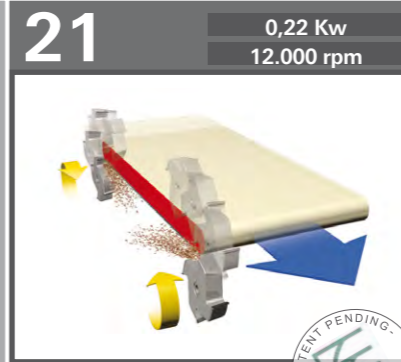

21 0,22 Kw
12.000 rpm

IT Arrotondatore
EN Corner Rounding Unit
FR Arrondir l'Angle
DE Eckenabruundaggregat
ES Redondeador de ángulo

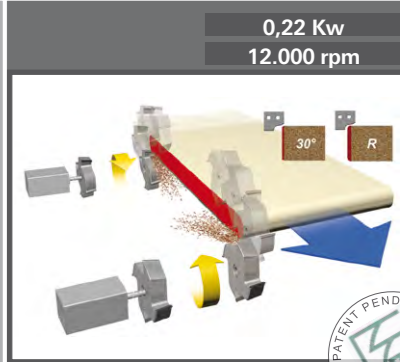
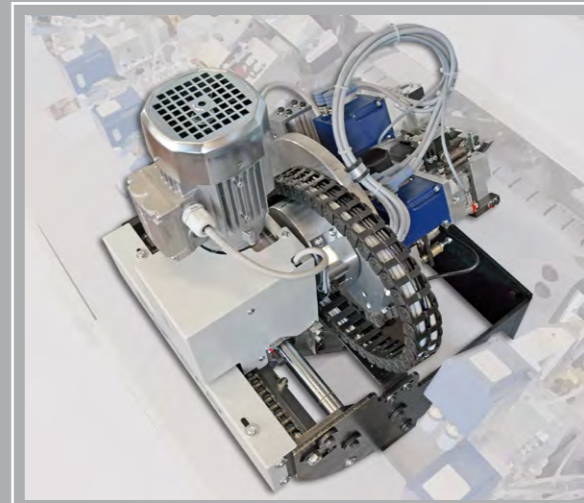

21 0,22 Kw
12.000 rpm

IT Arrotondatore con 2 assi controllati a CN
EN Rounding unit with 2 NC axis control
FR Arrondisseur avec 2 axes CN contrôlée
DE Abrundungsaggregat mit 2 NC-gesteuerten Achsen
ES Redondeador con 2 ejes controlados de CN

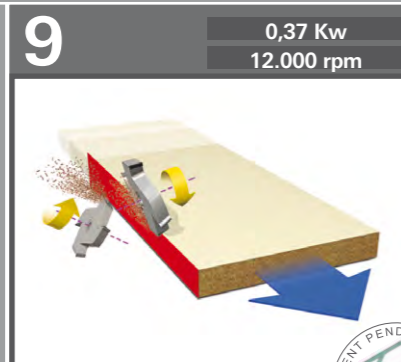
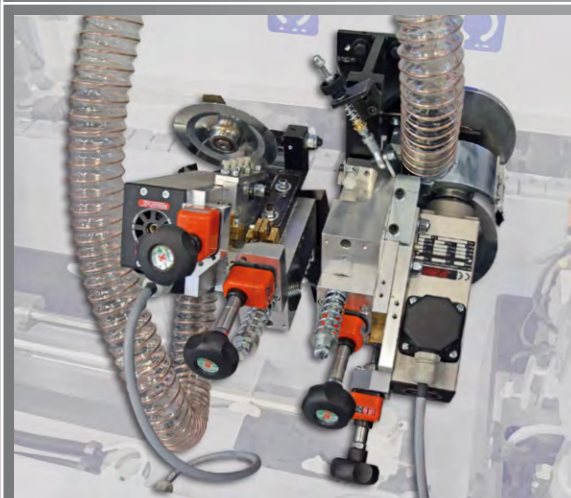

9 0,37 Kw
12.000 rpm

IT Rifilatore inclinabile
EN Heavy Duty Bevel Trim Unit
FR Dégrossés
DE Vorfräsen (Planfräsen)
ES Desbastador

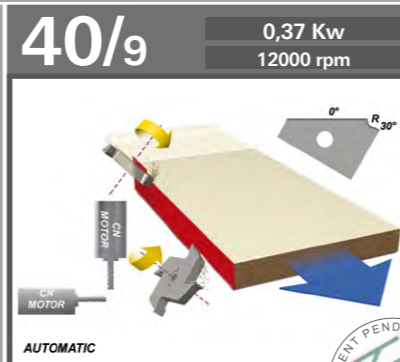

40/9 0,37 Kw
12000 rpm

IT Rifilatore 4 assi controllati
EN Trimming unit with 4 numerically controlled axis
FR Contrôle numérique à 4 axes contrôlés par le groupe rogneur
DE Numerische steuerung mit 4 gesteuerten achsen des bündigfräsaggregats
ES Control numérico a cuatro ejes controlados por el grupo biselador



10

IT Raschiatore
EN Scraping Unit
FR Racleur
DE Nachputzen
ES Rascador

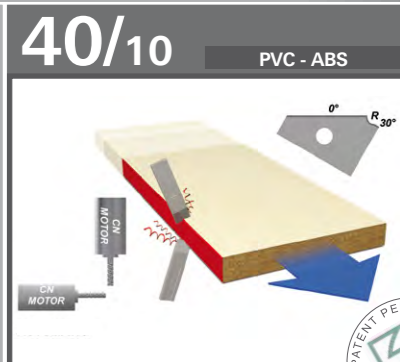
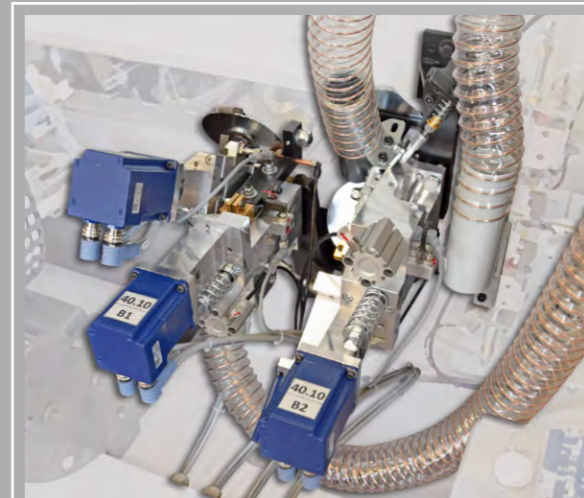

40/10 PVC - ABS

IT Raschiatore 4 assi controllati
EN Scraping unit with 4 Numerically controlled axis
FR Contrôle numérique à 4 axes contrôlés par le groupe racleur
DE Numerische steuerung mit 4 gesteuerten achsen des flachziehaggregats
ES Control numérico a cuatro ejes controlados por el grupo rascador

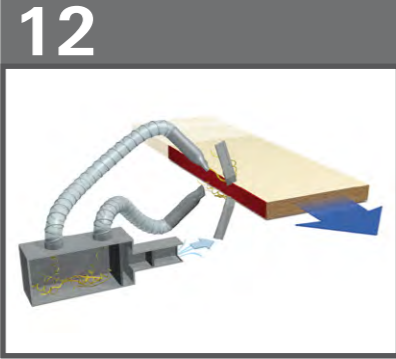

12
 IT Box trucioli
 EN Box for shavings
 FR Recipient pour copeaux
 DE Spanabfallbehälter
 ES Recipiente de recogida de las virutas

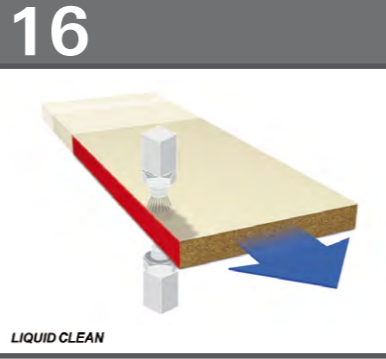
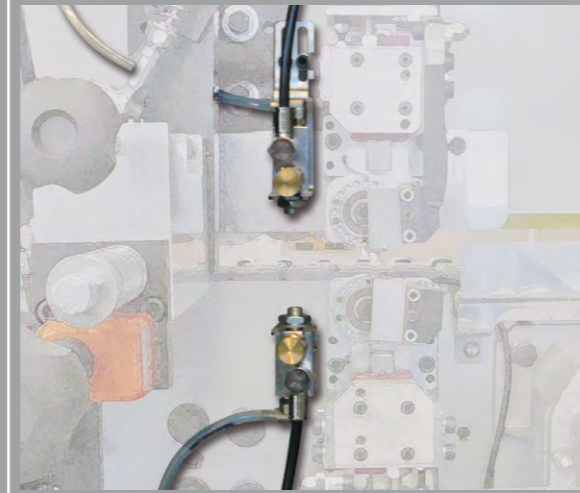

16
 IT Sistema di spruzzatura dell'agente pulente
 EN Cleaning agent spraying system
 FR Dispositif de lubrification nettoyant
 DE Reinigungsmittel-Sprühsystem
 ES Sistema de spray para agente limpiador

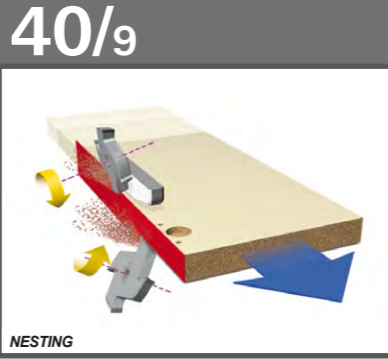
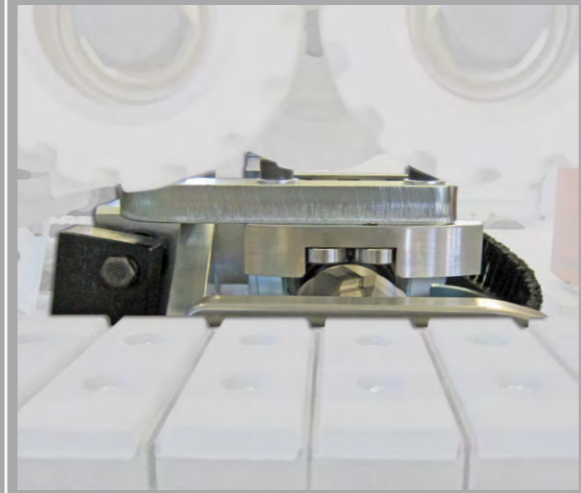

40/9
 IT Copiatori NESTING
 EN Copy NESTING
 FR Copieurs NESTING
 DE Kopierer NESTING
 ES Copiadores NESTING

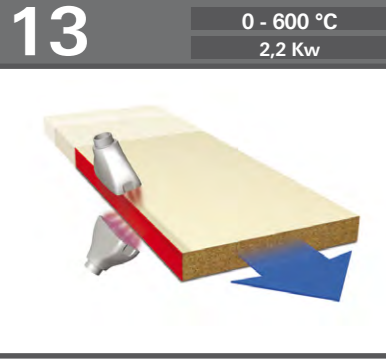

13
 0 - 600 °C
 2,2 Kw
 IT Phon aria calda
 EN Hot air blowers
 FR Souffleurs d'air chaud
 DE Heißluftgebläse
 ES Sopladores de aire caliente

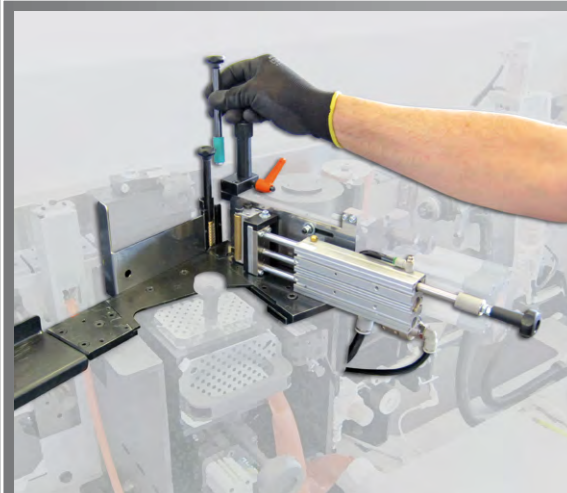

3
 AUTOMATIC
 IT Caricatore automatico bordi
 EN Edge-Feeding
 FR Charger le chant
 DE Kante zuführen
 ES Alimentacion del canto

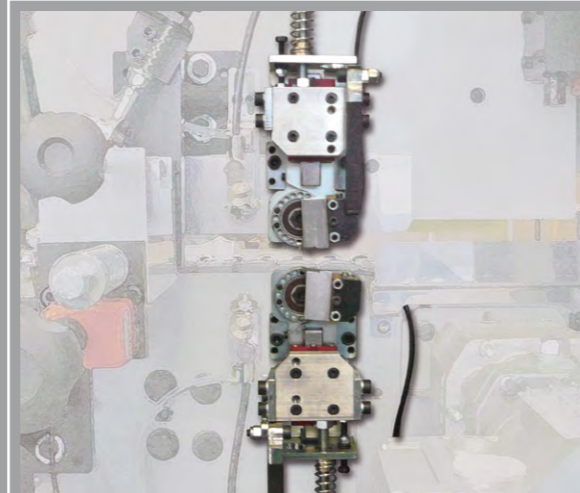

25
 IT Raschia colla
 EN Glue scraper
 FR Groupe racleur de colle
 DE Leimziehaggregat
 ES Grupo rascacola

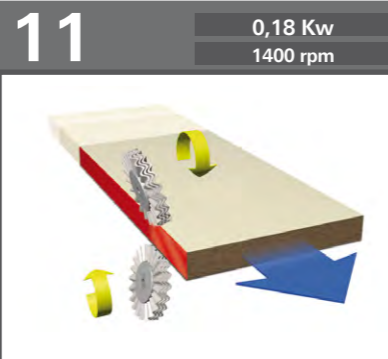
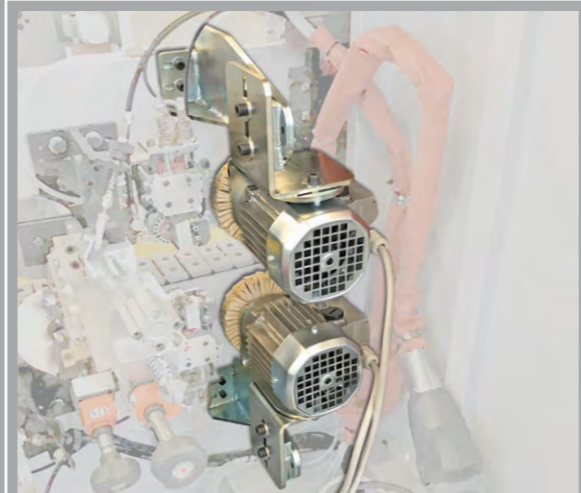

11
 0,18 Kw
 1400 rpm
 IT Spazzolatore
 EN Buffing Unit
 FR Brosses
 DE Schwabbeln
 ES Cepillado

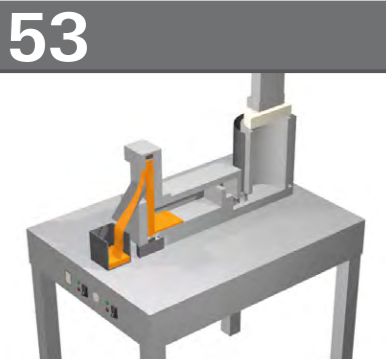

53
 IT Banco pulizia vasca colla
 EN Quick release glue tank cleaning bench
 FR Banc pour le nettoyage du bac a colle a décrochage rapide
 DE Leimbehälter-Reinigungstisch
 ES Mesa de limpieza deposito cola desenganche rápido



corner rounding unit

IT Competitor FRAVOL utilizzano:

- arrotondatori con movimentazione pneumatica;
- limitazione nel profilo nei pannelli da rifilare H=45;
- limitazione in 2 o 4 posizionamenti automatici preselezionati;
- utensile monoprofilo.

EN Competitor FRAVOL use:

- rounding corner unit with pneumatic movement;
- limited profile in the panels to be trimmed H=45;
- limitations in 2 or 4 preselected automatic positioning;
- single profile tool.

FR L'utilisation concurrent FRAVOL:

- arrondisseurs avec mouvement pneumatique;
- profil limitée dans les panneaux à être garnis H=45;
- les limites en 2 ou 4 positionnement automatique présélectionnés;
- outil profil unique.

DE FRAVOL-Wettbewerber verwenden:

- Abrundungsaggregate mit pneumatischer Bewegung;
- Begrenztes Profil der vorzufräsende Paneele H=45;
- Nur 2 oder 4 vorgewählte automatische Positionierungen;
- Einzelprofilwerkzeug.

ES Uso de la competencia FRAVOL:

- redondeado con movimiento neumático;
- Perfil limitado de los paneles para ser recortado H=45;
- Limitaciones en 2 o 4 de posicionamiento automático preseleccionados;
- Herramienta solo perfil.

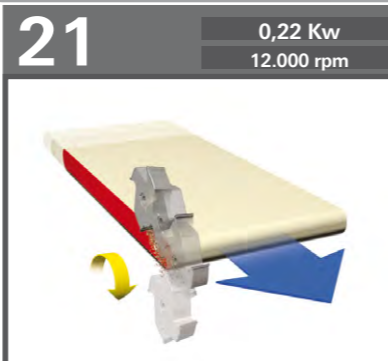
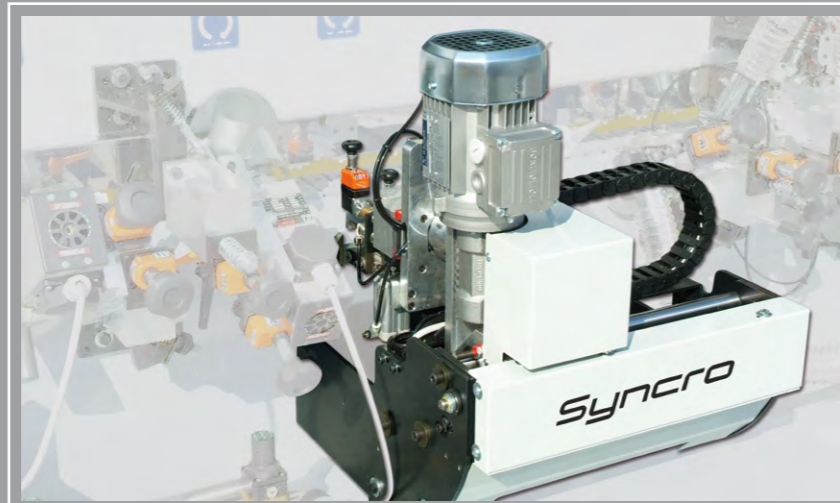

IT Arrotondatore
EN Corner Rounding Unit
FR Arrondir l'Angle
DE Eckenabruundaggregat
ES Redondeador de ángulo

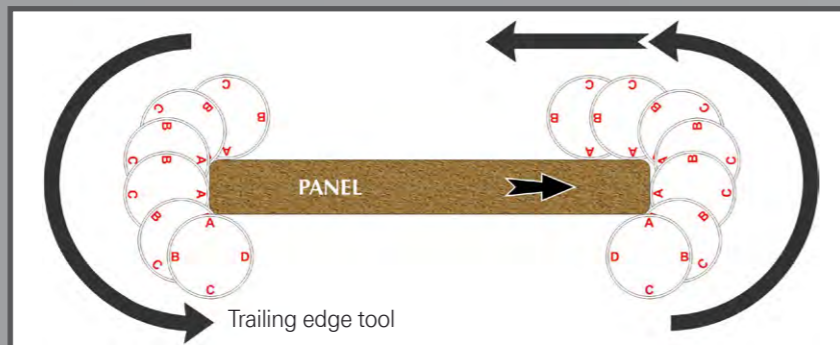

profile tools

unit 9-10-21

Position A

Position B

Position B

Position C

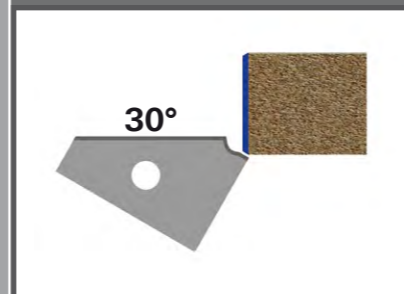
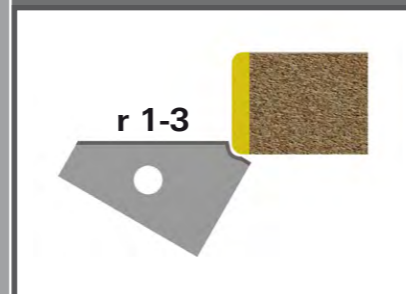
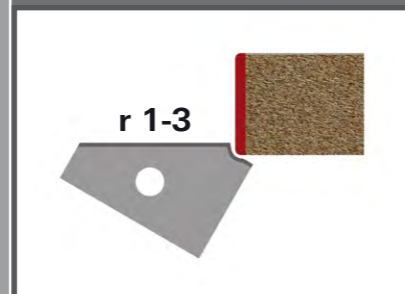
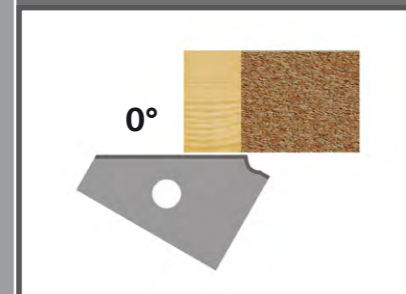
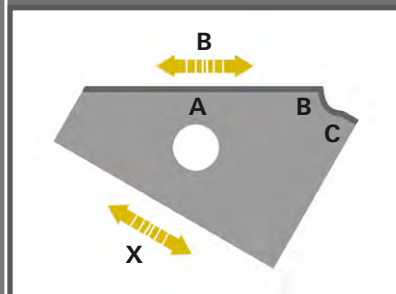

IT Utensile Rifilatore Raschiatore
EN Tool fine trimming Scraping unit
FR Outil affleurage - racleur
DE Vorfräs-Ziehklängenwerkzeug
ES Herramineta refilador - rascador

IT Profilo piano 0°
EN Flat profile 0°
FR Profil plan 0°
DE Flaches Profil 0°
ES Perfil plano 0°

IT Raggio profilo da 1,0 a 3,0
EN Radius profiles from 1,0 to 3,0
FR Profil rayon de 1,0 à 3,0
DE Profilradius von 1,0 bis 3,0
ES Perfil de radio de 1,0 a 3,0

IT Raggio profilo da 1,0 a 3,0
EN Radius profiles from 1,0 to 3,0
FR Profil rayon de 1,0 à 3,0
DE Profilradius von 1,0 bis 3,0
ES Perfil de radio de 1,0 a 3,0

IT Profilo inclinato a 30°
EN Inclined profile 30°
FR Profil incliné à 30°
DE Um 30° geneigtes Profil
ES Perfil inclinado a 30°

technical data

Modello - Model Modèle - Modell - Modelo	F200-23	F400-23	F600-23	F650-23 PLUS
Spessore pannello - Panel thickness Espaisseur panneau - Werkstückdicke Espesor panel	10 ÷ 60 mm	10 ÷ 60 mm	10 ÷ 60 mm	10 ÷ 60 mm
Larghezza pannello - Panel width Largeur Panneau - Werkstücklänge Largo panel	min. 60 mm	min. 60 mm	min. 60 mm	min. 60 mm
Larghezza bordo - Edge width Largeur chant - Kantenbreite Anchura canto	12 ÷ 63 mm	12 ÷ 63 mm	12 ÷ 63 mm	12 ÷ 63 mm
Spessore bordo - Edge thickness Espaisseur chant - Kantendicke Espesor canto	0,4 ÷ 6 mm	0,4 ÷ 6 mm	0,4 ÷ 6 mm	0,4 ÷ 8 mm
Avanzamento - Feed Avancement - Vorschub - Avance	10 m/min (STD)	10 m/min (STD)	10 m/min (STD)	12-16 m/min (STD)
Voltaggio - Voltage Voltage - Spannung - Voltaje	220/380 V 50/60 Hz - 3 Ph + N	220/380 V 50/60 Hz - 3 Ph + N	220/380 V 50/60 Hz - 3 Ph + N	220/380 V 50/60 Hz - 3 Ph + N
Lunghezza pannello - Panel length Longeur panel - Werkstücklänge Largo panel	min. 120 (PVC)	min. 120 (PVC)	min. 120 (PVC)	min. 120 (PVC)
Potenza installata - Installed power Puissance installée - Leistung installierte Potencia installada	8,0 kw	8,0 kw	8,2 kw	8,2 kw
Potenza pneumatica - Pneumatic power Puissance pneumatique - Leistung pneumatik Potencia neumático	6 bar	6 bar	6 bar	6 bar
Peso Kg. - Weight Kgs. Poids Kgs. - Gewicht Kgs. - Peso Kgs.	920	1000	1200	1200

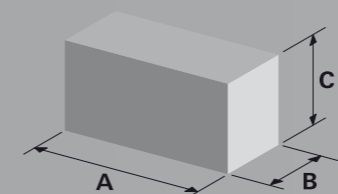

Dimensioni di imballo - Wood case dimensions

	F200-23	F400-23	F600-23	F650-23 PLUS
A	3100 mm	3450 mm	3960 mm	4100 mm
B	900 mm	900 mm	900 mm	900 mm
C	1670 mm	1670 mm	1670 mm	1670 mm



Fravol

macchine per la lavorazione del legno
manufacture of woodworking machines

uff. e dep.: via A. Niedda, 6 - 35010
Peraga di Vigonza - (PD) - Italy
tel. +39 - 049 725085 - 725888
fax +39 - 049 8931635
www.fravol.it - fravol@fravol.it