

SI|TEC

SAFETY TECHNOLOGY

EDITION 2021

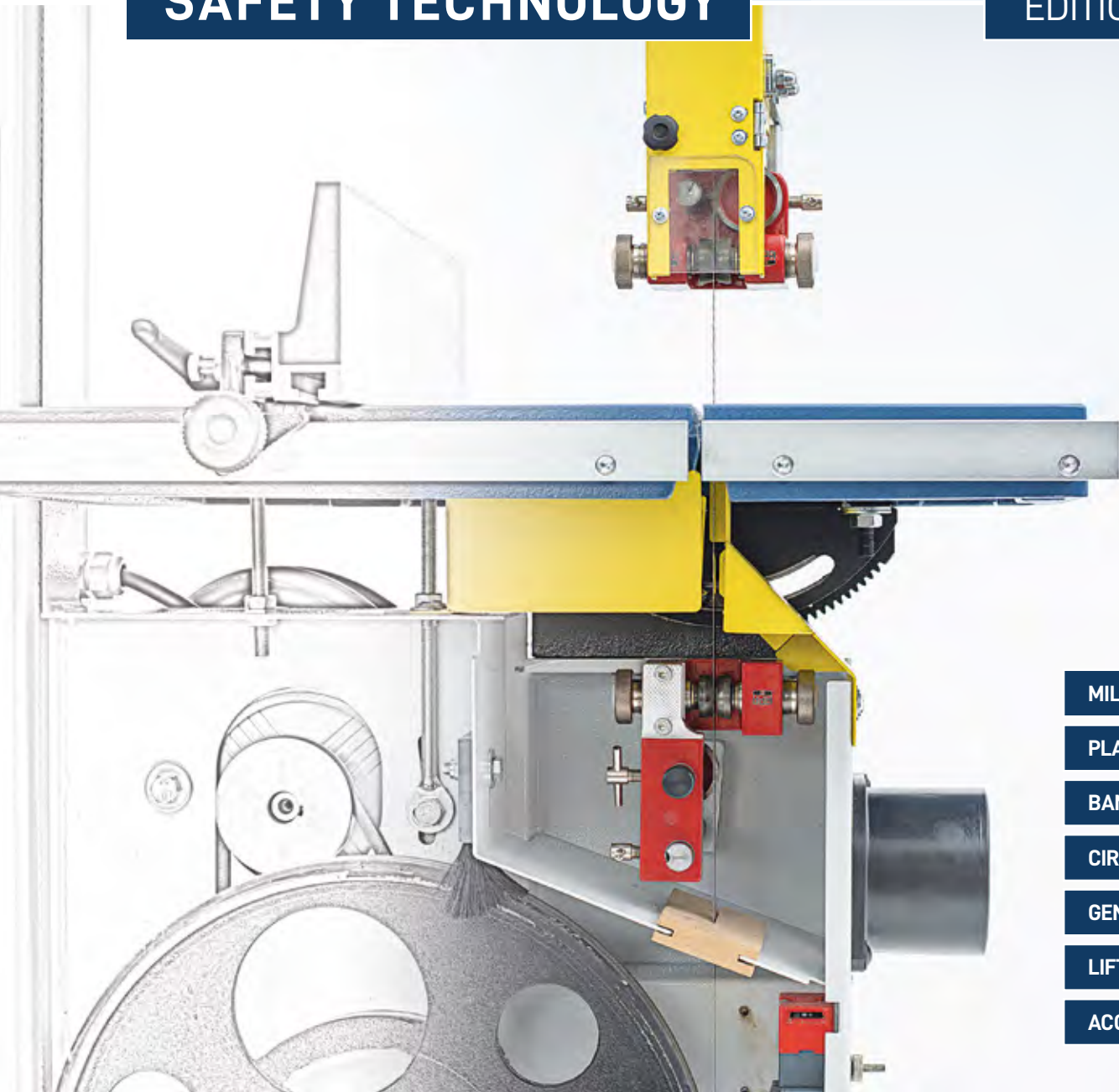

MILLING P.03

PLANING P.13

BAND SAWS P.27

CIRCULAR SAWS P.39

GENERAL P.49

LIFT TABLES P.55

ACCESSORIES P.63

SI|TEC-CATALOGUE

SAFETY TECHNOLOGY PRODUCTS

MADE IN GERMANY

SHOWROOM



TEST, EXPERIENCE AND FALL IN LOVE WITH OUR MACHINES AND ACCESSORIES ...

Our showroom at our production plant in Sigmaringen in southern Germany is a year-round product presentation, where our customers can see and try out products and machines. Test* our SI-TEC products directly on professional wood and plastic processing machines before buying. We would also be happy to advise you personally on site.

WE OFFER YOU:

- Machine demonstrations and qualified advice from experts
- Professional training for your personal protection
- Explanation of functions and accessories

*For safety reasons please make sure to use your own tools when testing the machines

LEGAL NOTICE

HO|KU|BE|MA Maschinenbau GmbH

Anton-Günther-Straße 3-7

D-72488 Sigmaringen

Phone: +49 (0)7571 755-0

Fax: +49 (0)7571 755-222

info@hokubema-panhans.de

www.PANHANS.de

www.ichbinWOODPECKER.de

www.HOKUBEMA.com



#Holzkunststoffbearbeitungsmaschinen

#ergohubtische

Managing director: Reinhold Beck

Factory manager: Alexander Beck

Status 06|2021

Technical and optical changes reserved.
No liability for errors and changed images.

MADE IN GERMANY

PANHANS
QUALITÄT SEIT 1918

SIITEC
SICHERHEITSTECHNIK



R. Beck
Maschinenbau



Reinhold Beck,
Managing director (right in the photo)
Alexander Beck,
Factory manager (left in the photo)

ACCESSORIES, PRODUCTS AND MORE - SAFETY TECHNOLOGY FROM SI-TEC

HO|KU|BE|MA Maschinenbau GmbH is a family-run company that develops and sells both reliable and innovative machines for PANHANS, but also for the still young brand WOODPECKER.

As a competent specialist company, an extensive range of services is offered in the development and manufacture of machines and systems for wood, plastic and metal processing companies. The company, steeped in tradition, combines many years of professional knowledge with the most modern requirements of today and develops innovative solutions. As a successful, medium-sized company, high-quality machines and products with precision "Made in Germany" are produced at the Sigmaringen location in Baden-Württemberg.

SI-TEC products show a wide range of safety technology and accessories for optimal working safety when drilling, milling, planing and sawing. These include

band saw blade guides, milling and mitre fences, planing guards, riving knives, protective covers or brand new: a retrofittable, electronic key system for machine activation.

With a wide range of optional extensions, HO|KU|BE|MA enables individual adaptation to the needs of the customer and ensures more safety at the workplace. With our developments, ideas and innovations as well as high-quality products from competent partners, we not only want to satisfy you as a customer, but also encourage you to enjoy working with products from HO|KU|BE|MA. We see ourselves not only as a service provider and supplier, but much more than the specialist partner at your side.

Our online shop www.hokubema.com allows you to order additional equipment, spare parts and additional accessories for any workshop area comfortably and at any time from home, without depending on the telephone service hours.

Reinhold Beck
REINHOLD BECK
MANAGING DIRECTOR

Alexander Beck
ALEXANDER BECK
FACTORY MANAGER

MILLING

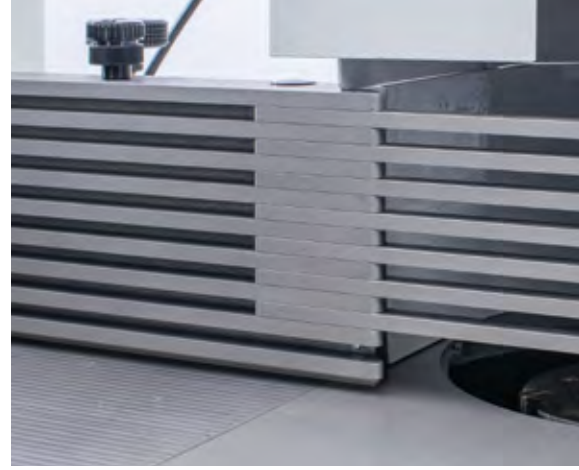

MORE ECONOMIC, SAFE AND EFFECTIVE – THE MODERN MILLING OF TODAY

Precise work at the highest level is required to manufacture a wide variety of parts. Components must be made to fit and brought together later. This precision work requires not only specific tools, but also a reliable machine with a pleasant and advantageous operating concept as well as well thought-out and, above all, effective safety technology. Milling fence, swiveling device and more enable future-oriented work on the machine.





ABOUT US P.01

MILLING P.03

PLANING P.13

BAND SAWS P.27

CIRCULAR SAWS S.39

GENERAL P.49

LIFT TABLES P.55

ACCESSOIRES P.63

APPENDIX P.73

MILLING

SAFETY SHAPER FENCE 215	04
SAFETY SHAPER FENCE 216	04
CLAMPING LEVER FOR SHAPER FENCE 215 / 216	04
SAFETY SHAPER FENCE 204	04
SWIVEL DEVICE 219	05
SHAPER AND PROTECTION DEVICE CENTREX 1624	05
SPACER FOR CENTREX 1624	05
SHAPING, PROTECTION AND PRESSING DEVICE GAMMA V 1629	05
MOUNTING BRACKET GAMMA V	05
PRESSURE SHOE FOR GAMMA V 1629	05
SAFETY FENCE PLATES SET 208	06
SAFETY RULERS AND MOULDING BOARD SET	06
SPARE PARTS FOR SAFETY FENCE PLATES 208	06
INTEGRAL FENCE 211	07
SPARE PARTS FOR INTEGRAL FENCE 211	07
SPACER FOR INTEGRAL FENCE 211	07
FILLING BAR FOR INTEGRAL FENCE 211	07
FEEDER PV 84	08
SPECIAL ACCESSORIES FOR FEEDER PV 84	08
FEEDER VARIOMATIC 4 N	08
RING FENCE TAPOA 1639	08
RING FENCE KOALA 1637	09
TENON CUTTING AND SLITTING DEVICE 1376	09
PROTECTING COVER 1641	09
SPARE PROTECTION HOOD	09
CONTERMAX 221	10
CLAMPING STRIP 212	10
KICKBACK PROTECTION 1648	10
TABLE EXTENSION WITH KICKBACK PROTECTION	10

MILLING



SAFETY SHAPER FENCE 215

In cast aluminium, with break-out free aluminium splinter tabs, bilateral fine adjustment and overall fence adjustment by handwheel.

- Max. tool diameter 250 mm
- Simple mounting on the machine table thanks to a drill template
- Bore distance clamp lever 365 mm
- 2 x clamp lever included

NOTICE: In Europe shapers with manual infeed requires a tool cover! The following ones are suitable:

Shaper and pressing device Gamma V Type 1629, Art. 2204

Shaper, protection and pressing device Centrex type 1624, Art. 2007

ca. 46,1kg

With grey cast-iron fence plates **2.467,00 €**
Art.: 2053 EACH

Without fence plates **2.087,00 €**
Art.: 2059 EACH



SAFETY SHAPER FENCE 216

In cast aluminium with break-out free aluminium splinter tabs, with bilateral fine adjustment and overall fence adjustment by handwheel according to digital display adjustable to 1/10 against the tool.

- Max. tool diameter 250 mm
- Simple mounting on the machine table thanks to a drill template
- Bore distance clamp lever 365 mm
- 2 x clamp lever included

ca. 46,5kg

With grey cast-iron fence plates **2.810,00 €**
Art.: 2036 EACH

Without fence plates **2.397,00 €**
Art.: 2127 EACH



CLAMPING LEVER FOR SHAPER FENCE 215 / 216

The shaper fence is fastened movably in the groove of the longitudinal struts with the clamping lever and thus ensures a good hold. Made of high-quality material, it is reliable, robust and durable on the machine.

Complete system with washers **36,50 €**
Art.: 2244 EACH

Complete system with washers **36,50 €**
(suitable for shaper fences from year of manufacture 2016)
Art.: 2243 EACH



SAFETY SHAPER FENCE 204

In cast aluminium with break-out free splinter tabs. Comfort clamping for a quick fastening of the shaper fence on the machine table. With bilateral handwheels the overall adjustment of the fence plates and single adjustment of the right plate. Measure reading through 2 digital displays with a 1/10 mm precision.

- Max. tool diameter 250 mm
- Simple mounting on the machine table thanks to a drill template
- Bore distance clamping lever 585mm

ca. 66,0kg

With grey cast-iron fence plates **5.758,00 €**
Art.: 4401 EACH

Without fence plates **5.290,00 €**
Art.: 4402 EACH

1 set adapters for the mounting of integral fence plates **104,00 €**
Art.: 2128 EACH



SWIVEL DEVICE 219

The swivel device is manually hydraulic and grants for a comfortable and secure lifting and pivoting aside of a PANHANS shaper fence to a neutral position without physical effort.

ca. 44,0kg

Swivel device 219
Art.: 4349

1.284,00 €
EACH



SHAPER AND PROTECTION DEVICE CENTREX 1624

Fits all shaper fences. Secure fastening of the workpiece for manual shaping. The special shape of the pressure shoe grants for a precise control of the workpiece in all shaping works and is steplessly adjustable vertically and horizontally. Good view of the workpiece.

Necessary mounting parts for shaper fence 215/216:

- Mounting bracket GAMMA V
- Spacer Art.: 6609.0421

Shaper and protection device CENTREX 1624
Art.: 2007

548,50 €
EACH

SPACER FOR CENTREX 1624

For the mounting on the mounting bracket GAMMA V.

Spacer for CENTREX 1624
Art.: 6609.0421

27,60 €
EACH



SHAPING, PROTECTION AND PRESSING DEVICE GAMMA V 1629

Fits all shaper fences, steplessly adjustable horizontally and vertically, arresting in folded-up position.

Necessary mounting parts for shaper fence 215/216:

- Mounting bracket GAMMA V

A bracket, if needed, must be adapted on site.

ca. 7,3kg

Shaping, protection and pressing device GAMMA V 1629
Art.: 2204

378,00 €
EACH



MOUNTING BRACKET GAMMA V

Bracket for mounting of the shaping, protection and pressing device CENTREX 1624 und GAMMA V 1629.

On shaper fences 215/216
Art.: 2110

46,80 €
EACH



PRESSING SHOE FOR GAMMA V 1629

Part of the shaping, protection and pressing device granting for the guiding of the workpiece.

Pressing shoe for GAMMA V 1629
Art.: 2249

156,30 €
EACH

MILLING



SAFETY FENCE PLATES SET 208

For mounting on an existing shaper fence.

The set consists of:

- 2 cast-iron fence plates 430mm long
- 2 groove profile rails
- 2 splinter tabs in wood
- 2 rulers 260x6 mm
- 3 rulers 260x3 mm
- 1 moulding board in wood
- 8 slide blocks in steel with screws
- 10 slide blocks, twistable, in brass with screws
- 1 allen key
- 2 eccentric clamps

ca. 22,6 kg

Safety fence plates set 208

Art.: 2083

678,00 €

EACH



SAFETY RULERS AND MOULDING BOARD SET

1 Set = 5 safety rulers consisting of:

- 3 rulers 260x3 mm
- 2 rulers 260x6 mm
- 1 moulding board in wood
- 10 slide blocks in brass with screws
- 4 slide blocks in steel with screws
- 1 allen key

ca. 1,3kg

Safety rulers and moulding board set

Art.: 2093

182,00 €

EACH

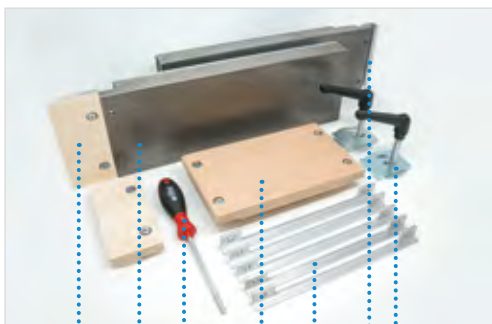

SPARE PARTS FOR SAFETY FENCE PLATES 208

1 Cast-iron fence plate 430 mm long	219,50 €
Art.: 2095	EACH
2 Groove profile rail	18,90 €
Art.: 2073	EACH
3 Splinter tab, wood	15,30 €
Art.: 2087	EACH
Splinter tab, aluminium	23,30 €
Art.: 2038	EACH
4 Ruler without slide blocks and screws: 260 x 3 mm	16,20 €
Art.: 2084	EACH
4 Ruler without slide blocks and screws: 260 x 6 mm	16,70 €
Art.: 2085	EACH
4 Ruler without slide blocks and screws: 300 x 3 mm	17,90 €
Art.: 2116	EACH
4 Ruler without slide blocks and screws: 300 x 6 mm	18,60 €
Art.: 2117	EACH
5 Moulding board in wood	25,90 €
Art.: 2086	EACH
Slide block in steel with screw for splinter tab and moulding board	4,10 €
Art.: 2088	EACH
Slide block twistable in brass with screw for rulers	4,90 €
Art.: 2044	EACH
6 Allen key	17,50 €
Art.: 2092	EACH
7 Eccentric clamp with clamping lever screw	41,90 €
Art.: 2062	EACH

- 1 Cast-iron fence plate 430 mm long
- 2 Groove profile rail
- 3 Splinter tab
- 4 Ruler without slide block and screws
- 5 Moulding board in wood
- 6 Allen key
- 7 Eccentric clamp with clamping lever screw

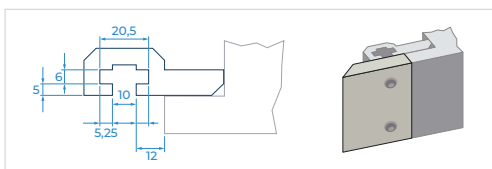

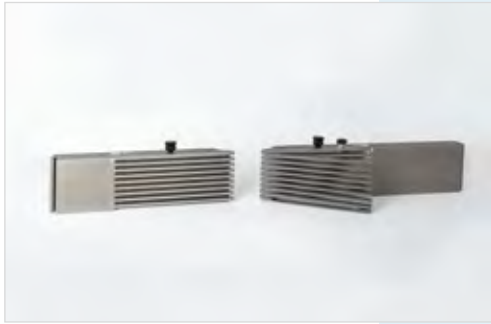

INTEGRAL FENCE 211

To be mounted on an existing shaper fence, for precise and secure working on spindle moulders. The integral fence grants for a gapless guiding surface for all shaping works on the tool. Precise adapting to the tool diameter and height through a stepless regulation.

The hard coating of the guide rods grants for a continuous guiding surface at all times.

Both sides 500 mm long

ca. 14,7 kg
Art.: 2120

1.289,50 €
EACH

Left side 500 mm long Right side 650 mm long

ca. 17,3 kg
Art.: 2121

1.364,50 €
EACH

Left side 650 mm long Right side 500 mm long

ca. 17,3 kg
Art.: 2122

1.179,50 €
EACH

Both sides 650 mm long

ca. 20,3 kg
Art.: 2123

1.498,50 €
EACH

1 set of adapter for the mounting of integral fence plates on shaper fence 204

Art.: 2128

104,50 €
EACH

SPARE PARTS FOR INTEGRAL FENCE 211

Bottom strip

Art.: 2124

60,20 €
EACH

Strip

Art.: 2125

34,00 €
EACH

Axial pin

Art.: 2126

7,96 €
EACH



SPACER FOR INTEGRAL FENCE 211

Indispensable for shaping of slightly tipping workpieces with the integral fence. The spacer is clamped to a groove of the integral fence at the desired height.

ca. 400g

Spacer for integral fence

Art.: 2118

56,60 €
EACH

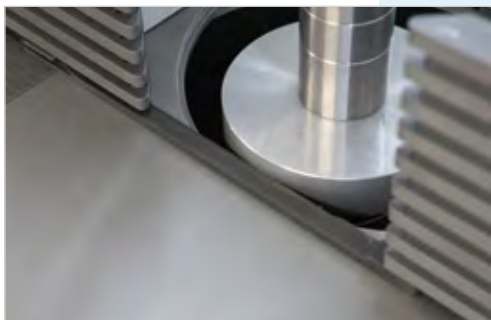

FILLING BAR FOR THE INTEGRAL FENCE 211

For secure guidance of thin workpieces along the integral fence. The filling bar closes the lower cut-out on the left side of the fence, creating a gapless guide surface also in this area. The surface is tempered with a hard-coat layer.

ca. 200g

Filling bar for integral fence

Art.: 2119

53,10 €
EACH

MILLING



FEEDER PV 84

- 4 rollers 120x60 mm
- 8 speeds (2/4/5,5/6,7/11/13/16,5/33 m/min)
- Stand with extension arm 1050 mm
- Clockwise and counterclockwise rotation with 2 speeds, switch operated
- Further speeds adjustable via 2 steps switching gear
- Metal gear for the adjustment of other 4 speeds
- Individually usable horizontally and vertically
- Individually adjustable

ca. 68,0kg

Feeder PV 84

Art.: 4023

1.448,00 €

EACH

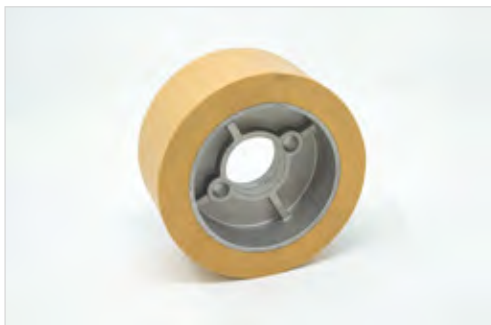

SPECIAL ACCESSORIES FOR FEEDER PV 84

Spare infeed roller with two-part rim

Art.: 4024

30,90 €

EACH

Spare infeed roller with vulcanized rim

Art.: 4027

49,40 €

EACH



FEEDER VARIOMATIC 4 N

- 4 rollers (roller width divided 2x25mm, roller diameter 120 mm)
- Stepless speed 2–18 m/min
- Right and leftward rotation
- Fast turning from horizontal to vertical operation
- Simple swivelling and positioning
- Memory-Lock-System for accurately repeatable fixing
- Comfortable stand
- Numerical height indication
- Extension arm 1050mm long

Feeder Variomatic 4 N

Art.: 4103

2.998,00 €

EACH

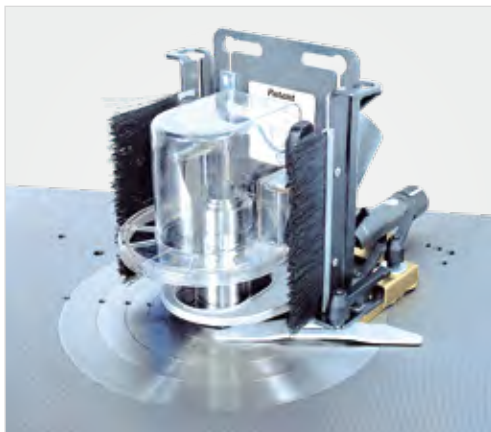

RING FENCE TAPOA 1639

FOR TOOLS UP TO Ø 160 MM

For accident-safe shaping of curved workpieces on the spindle moulder. With pressure and protection ring, start-up ring and stop bar, as well as fine adjustment of the shaping depth and suction nozzles Ø 120 mm.

The ring fence can be mounted and adjusted on any spindle moulder. Workpieces can be processed in left and rightward operation. The transparent protecting cover grants for a perfect view of the tool.

ca. 5,5kg

Ring fence TAPOA 1639

Art.: 2246

419,90 €

EACH



RING FENCE KOALA 1637 FOR TOOLS UP TO Ø 220 MM

For accident-safe shaping of curved workpieces on the spindle moulder. With pressure and protection ring, 2 start-up rings and stop bar, as well as fine adjustment of the shaping depth and suction nozzles ø 120 mm. The ring fence can be mounted and adjusted on any spindle moulder. Workpieces can be processed in left and rightward operation. The transparent protecting cover grants for a perfect view of the tool.

ca. 11,0kg

Ring fence KOALA 1637
Art.: 2245

608,80 €
EACH



TENON CUTTING AND SLITTING DEVICE 1376

For usage on spindle moulders, with simple mounting on the machine table. With adjustable mitre fence from 30° to 150°. The sliding table runs smoothly on ball bearings.

- Length of the base plate: 1000 mm
- Sliding path: 710 mm
- Sliding table size: 295x255 mm
- Height of slide plate: approx. 56 mm

Recommended accessory: protecting cover type 1641.

ca. 44,5kg

Tenon cutting and slitting device 1376
Art.: 2221

1.929,00 €
EACH



PROTECTING COVER 1641

For tenon cutting and slot discs up to max. ø 350 mm. Made of a strong steel sheet, with adjustable protective lid and suction nozzles ø 120 mm. Distance between fixing screws 560 mm.

ca. 18,4kg

Protecting cover 1641
Art.: 2235

527,50 €
EACH



SPARE PROTECTION HOOD

For shaper fences 206, 207, 202 (as a replacement for the original plastic protective cover).

Spare protection hood
Art.: 2206

186,80 €
EACH

PERMANENT LUBRICATION CARTRIDGE | AT PAGE 53

PNEUMATIC CLAMPING DEVICE | AT PAGE 53

ELECTRONIC KEY SYSTEM FOR MACHINE
ACTIVATION | AT PAGE 50

MILLING



CONTERMAX 221

For precise and quick profiling of workpieces at the transverse side. Contermax allows a secure and economic work. The precise guidance of the workpieces achieves a high dimensional accuracy. The innovative clamp provides for an extremely quick change.

ca. 1,6 kg

CONTERMAX 221
Art.: 3054

119,80 €
EACH



CLAMPING STRIP 212

For quick and secure insertion shaping of short workpieces. Stable, light design, made of aluminium.

- Length 800 mm
- Clamping length 550 mm

ca. 3,4 kg

Clamping strip 212
Art.: 3053

228,20 €
EACH



KICKBACK PROTECTION 1648

For spindle moulders with table extensions, steplessly adjustable from 0 to 1500 mm, suitable for insertion shaping of long and short parts. Mounting parts for the installation on existing table extensions included.

Recommended accessory: clamping strip type 212, Art. 3053

ca. 12,4 kg

Kickback protection 1648
Art.: 2002

512,20 €
EACH



TABLE EXTENSION WITH KICKBACK PROTECTION

With cross stop (400 mm long) for insertion shaping, steplessly adjustable.

- Cross stop swivelling at 90° and easy to remove
- Secure and quick mounting on the fixing rail
- Easily movable and simple to remove
- Supporting foot can be folded, ensuring minimum space requirement
- Table in anodized aluminium
- Length 1100 mm, width 172 mm

Table extension without mounting rails
Art.: 3056

217,30 €
EACH



THE NEW ONLINESHOP FOR WOOD CRAFTSMEN!

24 hours a day, 7 days a week, 365 days a year:

Now you can order conveniently from home or your workshop equipment,
Machines, spare parts, consumables, accessories and much more
Order online without worrying about the telephone service hours.

**Ordering at our Shop you can save time that you can spend in a
better way.**

**WITH THIS CODE
YOU SAVE 5,00 € ON YOUR
NEXT ORDER:**

SiTec-2021

VOUCHER CODE

PRACTICAL

AT ANY TIME

FAST

Redeemable once in our online shop until 31/12/2021
for your next order from a purchase value of € 50.00.
Cannot be combined with other discounts.

 www.hokubema.com

PLANING

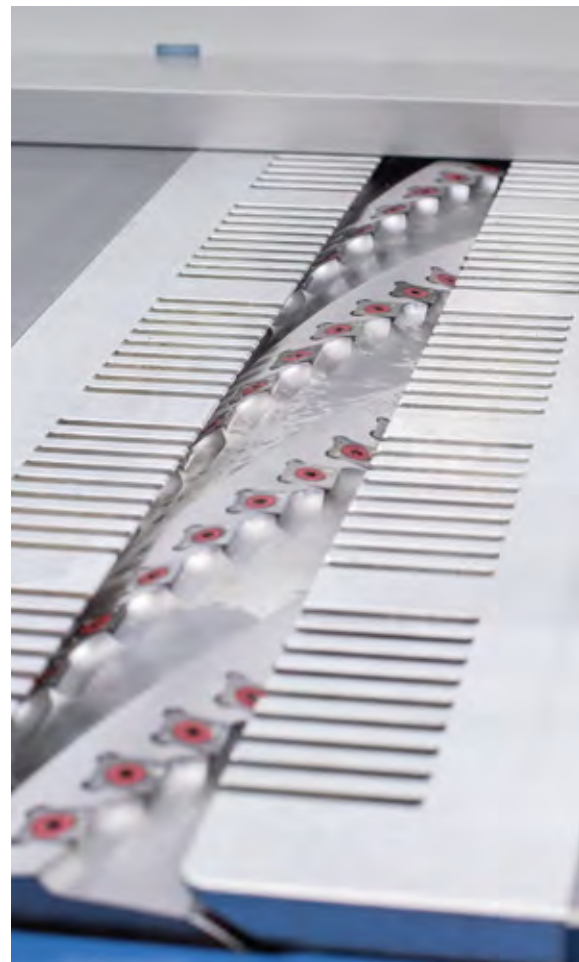
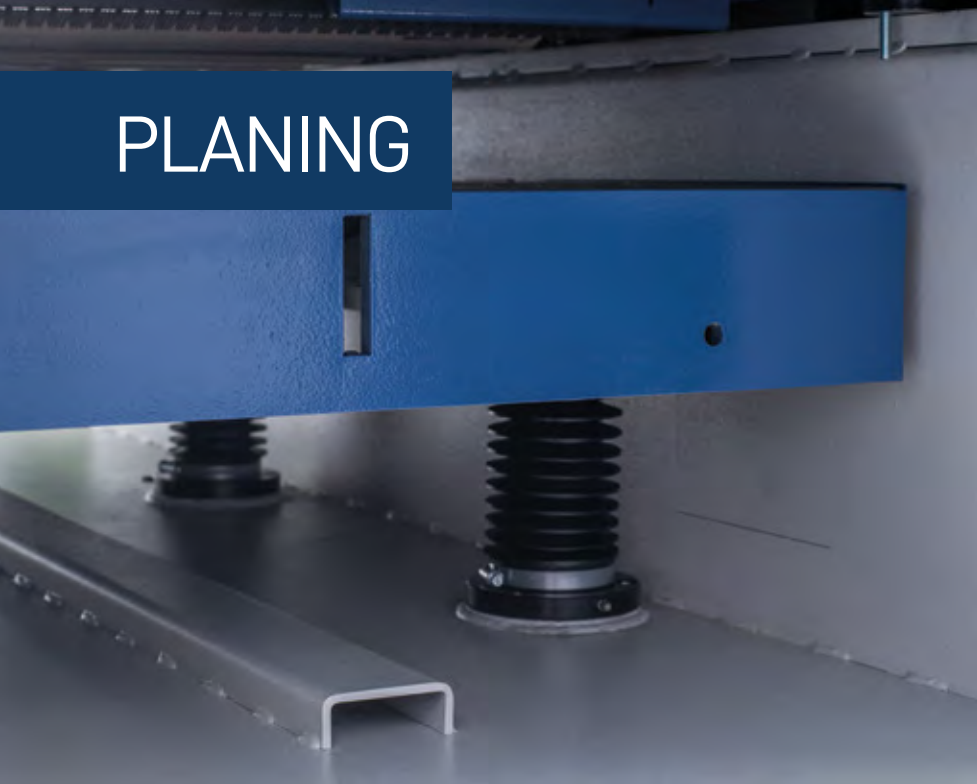

PLANING WITH LABOUR-SAVING FUNCTIONS

Surface and thickness planers is one of the top performing machines in every workshop. The surface and thickness planer is required when straightening rough sawn solid wood and then brings it to a uniform thickness. In order to parallelize the surfaces and smooth the surface for further processing, all sides must be processed. Many useful and work-saving functions are already part of the standard version of the surface and thickness planing machine. Additional equipment makes processing easier and brings more security to the workshop.



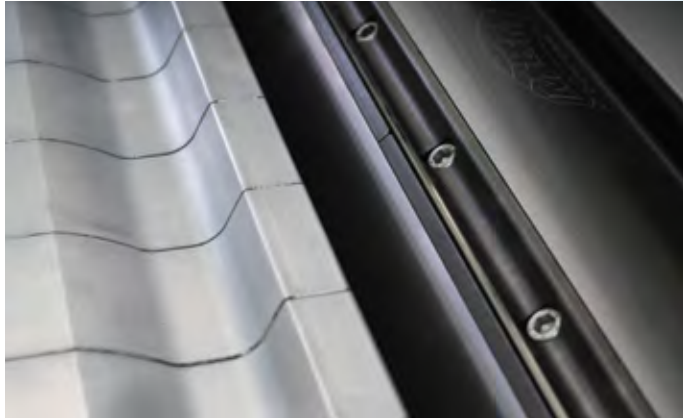

ABOUT US SP01

MILLING P.03

PLANING P.13

BAND SAWS P.27

CIRCULAR SAWS P.39

GENERAL P.49

LIFT TABLES P.55

ACCESSORIES P.63

APPENDIX P.73

PLANING

PLANING PROTECTION DEVICE 1570	14
PLANING PROTECTION DEVICE TX-R	14
OPTIONAL COVERS FOR MODELS 1570 AND TX-R	14
SPARE PARTS	14
TWO-PART PLANING PROTECTION DEVICE TX-MATIC	15
SUVAMATIC COVER TWO-PIECE	17
SUVA KNIFE SHAFT COVER TWO-PIECE	17
SUVA INFEEEDING SYSTEM WITH WIDE FEEDING SPOUT	17
SUVA INFEEEDING SYSTEM WITH FOLDABLE FEEDING SPOUT	17
SUVA PARTS: HANDLE SUVA, HINGE SUVA, RUN ROLLER (FOR GUIDING THE CUTTER SHAFT COVER), WIRE ROPE (FOR WEIGHT RELIEF), ROPE DRUM WITHOUT WIRE ROPE, GAS SPRING STABILUS 10185672	18
PIVOTING AUXILIARY STOP 1545	20
SUPPLY DRAWER 1515	20
PLANING KNIFE 1505	20
THICKNESS TABLE EXTENSION 654	21
TERSA SPARE KNIFE	21
BRASS WEDGE FOR THE TERSA KNIFE SHAFT	21
SELF-ACTING SWIVEL PROTECTION 1560	21
SPARE PARTS FOR SWIVEL PROTECTION TYPE 1560	21
ADJUSTABLE MAGNETIC PLANING KNIFE QUICK SETTING DEVICES 1533	22
SERVICE SET FOR HELICAL CUTTERHEADS	22
SPARE BLADE FOR HELICAL CUTTERHEADS	22
SCREWS FOR SPARE KNIVES OF HELICAL CUTTERHEAD	22
SPARE BLADES FOR HELICAL CUTTERHEADS	23
TORQUE SCREWDRIVER 5.7 NM	23
BITS FOR TORX 1/4 INCH TX 20	23
CUTTERHEAD PRESSURE BARS	24
CUTTERHEAD SCREWS	24
WRENCH SW 17	24
CUTTERHEAD PRESSURE SPRING	24

PLANING



PLANING PROTECTION DEVICE 1570

TWO-PART, FOLDING-DOWN 1570, FOR SURFACE PLANERS

The two-part version provides for a comfortable work even with large workpieces, as it has no disruptive edge.

- Fixed part: 400 mm
- Folding part: 260 mm

TXF 500 mm with two-part cover, A = 500 mm Art.: 3406	374,30 € EACH
---	-------------------------

TXF 650 mm with two-part cover, A = 650 mm Art.: 3407	385,30 € EACH
---	-------------------------

TXF 850 mm with two-part cover, A = 850 mm Art.: 3408	518,40 € EACH
---	-------------------------

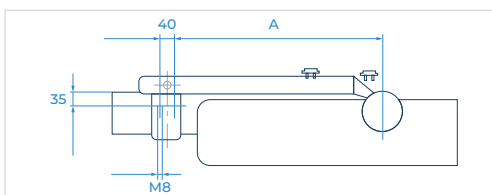

PLANING PROTECTION DEVICE TX-R

TWO-PART, FOLDING DOWN TX-R FOR COMBINED SURFACE AND THICKNESS PLANERS

Planing protection device TX-R 650 with cover, including swivel unit and adapter for fixing on the outfeed table. Especially suitable for combined planing machines with foldable table.

- Fixed part: 450 mm
- Folding part: 300 mm

Planing protection device TX-R Art.: 3415	497,20 € EACH
---	-------------------------

OPTIONAL COVERS FOR MODELS 1570 AND TX-R

TWO PARTS, FOLDING DOWN

- Fixed part: 400 mm
- Folding part: 400 mm

Planing protection device TX-R cover two-parts Art.: 3566	218,50 € EACH
---	-------------------------



SPARE PARTS

FOR THE PLANING PROTECTION DEVICE, MODELS 1570 AND TX-R

Gas spring for TXF 500/650, 300 N Art.: 3567	98,50 € EACH
--	------------------------

Gas spring for TXF 850, 400 N Art.: 3568	108,70 € EACH
--	-------------------------



TWO-PART PLANING PROTECTION DEVICE TX-MATIC

Protection device with two-part, folding-down cover for surface planers and combined surface and thickness planers, with spring-loaded surface pressure in height and side positions via the wheels on the workpiece. The wheels lift the protection cover to the height of the workpiece. Once the workpiece has been pushed through, the protection cover lowers back to the starting position. This ensures an optimal covering of the cutterhead. The wheels can be turned to the horizontal, vertical and 45° positions (providing thus for a constant pressure on the machine table/planing fence).

NOTICE: Each includes an additional holding plate (Art.: 6103.1854) for stiffening when mounting on front sheet metal covers.

**For planing width 410 + 510 mm
with two-part cover 420 + 320 mm**
Art.: 3412

1.141,70 €
EACH

**For planing width 630 mm
with two-part cover 550 + 320 mm**
Art.: 3413

1.165,70 €
EACH



THE NEW ONLINESHOP FOR WOOD CRAFTSMEN!

24 hours a day, 7 days a week, 365 days a year:

Now you can order equipment, machines, spare parts, consumables, accessories and much more online from the comfort of your home or workshop – without the hassle of opening hours:

 www.hokubema.com

PLANING

SUVAMATIC - PLANNER GUARDS

PROVEN
EVERY DAY IN THE
WORK FIELD

Suva's protective devices provide reliable protection against accidents at work and are also a real aid to work. Thanks to Suva's safety devices, accidents on woodworking machines have been massively reduced in recent years.

Suva protective devices are compliant. Well-known European machine manufacturers use them as standard on their machines. Suva protective devices can also be retrofitted to used machines without any problems. Suva offers suitable solutions for this purpose.

The Suvamatic is an indispensable tool for dressing and joining workpieces on the planer.

ADVANTAGES

- **Safe covering of the cutter block**
The whole planing area is secured with a single cutter block cover. It can be folded down via a hinge lock system.
- **Automatic lifting and lowering**
During planing, the knife shaft cover is automatically raised by the infeed spout. It then lowers again into the protective position.
- **Practical workpiece infeed**
The knife shaft cover is fitted with a pressure shoe and a reversible infeed spout on the side of the joining fence.
- **Can be fixed for repetitive work**
For repetitive work, the knife shaft cover can be fixed at work piece height.
- **Contact pressure as a working aid**
During joining, the knife shaft cover generates a contact pressure against the joining stop. After joining, it automatically returns to the protective position.
- **Fits all machines**
The planer guard can be mounted on all planers.



suva SUVAMATIC COVER TWO-PIECE FOR SURFACE PLANERS

The Suvamatic is an indispensable tool for dressing and joining workpieces on the planer.

- Safe covering of the cutter head
- Practical workpiece infeed
- Contact pressure as a working aid
- Automatic lifting and lowering
- Can be fixed for repetitive work
- Fits all machines

SUVAMATIC cover two-piece, useful length (l) > 340 mm – 515 mm	1.529,50 €
Art.: 3419	EACH

SUVAMATIC cover two-piece, useful length (l) > 340 mm – 655 mm	1.529,50 €
Art.: 4048	EACH

SUVAMATIC cover two-piece, useful length (l) > 340 mm – 755 mm	1.529,50 €
Art.: 3420	EACH



suva KNIFE SHAFT COVER TWO-PIECE SUVA

Knife shaft cover two-piece SUVA	311,50 €
Useful length 340 mm – 655 mm	EACH
Art.: 4048.1	

Knife shaft cover two-piece SUVA	329,50 €
Useful length 340 mm – 755 mm	EACH
Art.: 3420.1	



suva INFEEING SYSTEM WITH WIDE FEEDING SPOUT

With universal feeding spout, which does not have to be folded down for planing and joining work. Especially suitable for use in carpentry shops. To open the table, the spout can be raised so that the cutter cover can be fully retracted.

Infeeding system with wide feeding spout	151,40 €
Art.: 4041	EACH



suva INFEEING SYSTEM WITH FOLDABLE FEEDING SPOUT

Infeeding system with foldable feeding spout	88,70 €
Art.: 4161	EACH



suva HANDLE SUVA

HANDLE SUVA
Art.: 4057

28,00 €
EACH



suva HINGE SUVA

HINGE SUVA
Art.: 4050

119,30 €
EACH



suva RUN ROLLER (FOR GUIDING THE CUTTER SHAFT COVER)

Run roller (for guiding the cutter shaft cover)
Art.: 4044

34,90 €
EACH



suva WIRE ROPE (FOR WEIGHT RELIEF)

Wire rope (for weight relief) Length 400 mm
Art.: 4700

22,20 €
EACH

Wire rope (for weight relief) Length 1100 mm
Art.: 4701

27,50 €
EACH





suva ROPE DRUM WITHOUT WIRE ROPE

Rope drum without wire rope (for knife shaft cover) **88,70 €**
Art.: 4706 EACH

Rope drum without wire rope (for weight relief) **78,20 €**
Art.: 4707 EACH



suva GAS SPRING STABILUS 10185672

Gas spring stabilus 10185672 **43,30 €**
Art.: 4708 EACH

**OTHER SPARE PARTS
FOR SUVA ON REQUEST**



NEW SUVA-PARTS IN THE ONLINE STORE NOW!

24 hours a day, 7 days a week, 365 days a year:

Now you can order equipment, machines, spare parts, consumables, accessories and much more online from the comfort of your home or workshop – without the hassle of opening hours:

 www.hokubema.com

PLANING

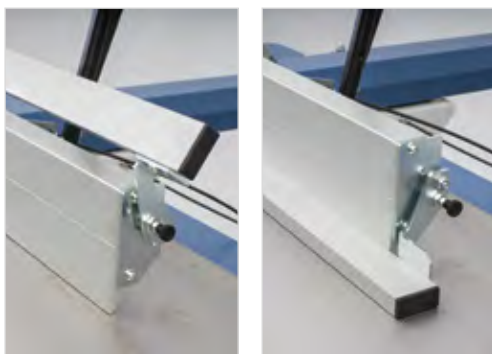

PIVOTING AUXILIARY STOP 1545

For secure surfacing of narrow workpieces on the surface fence. Suitable for surfacing length max. 1500 mm. Simple, tool-free opening and closing for immediate use.

ca. 2,3kg

Pivoting auxiliary stop 1545

Art.: 3398

330,50 €

EACH



SUPPLY DRAWER 1515

For secure surfacing of short workpieces.

ca. 600g

Supply drawer 1515

Art.: 3052

31,90 €

EACH



PLANING KNIFE 1505

PROVEN PERMANENT CUTTING STEEL GRANAT

LENGTH	WIDTH	THICKNESS		
410 mm	35 mm	3 mm	Art.: 3304	24,90 €
510 mm	35 mm	3 mm	Art.: 3306	80,20 €
520 mm	35 mm	3 mm	Art.: 3320	53,30 €
610 mm	35 mm	3 mm	Art.: 3307	27,80 €
630 mm	35 mm	3 mm	Art.: 3308	74,40 €
640 mm	35 mm	3 mm	Art.: 3309	29,10 €
810 mm	35 mm	3 mm	Art.: 3377	48,90 €



HSS STEEL (18 % TUNGSTEN*) GRANAT RAPID

LENGTH	WIDTH	THICKNESS		
410 mm	35 mm	3 mm	Art.: 3313	52,50 €
510 mm	35 mm	3 mm	Art.: 3315	73,90 €
520 mm	35 mm	3 mm	Art.: 3321	87,70 €
610 mm	35 mm	3 mm	Art.: 3316	98,90 €
630 mm	35 mm	3 mm	Art.: 3317	99,40 €
640 mm	35 mm	3 mm	Art.: 3318	112,60 €
810 mm	35 mm	3 mm	Art.: 3554	122,70 €

* for highest performance and long service life

RECOMMENDED ACCESSORY:

MAGNETIC PLANING KNIFE QUICK SETTING DEVICES | AT PAGE 22

CUTTERHEAD PRESSURE SPRING | AT PAGE 24



THICKNESS TABLE EXTENSION 654

Robust sheet steel construction for retrofitting on planing machines. The automatic height adjustment in connection with the link chain withstands the highest loads. When planing long workpieces, the pressure beam is relieved and at the same time the workpiece is prevented from tipping over.

ca. 44,0kg Table size 1000x630mm (LxW)

Thickness table extension 654 **949,00 €**
Art.: 4496 EACH



TERSA SPARE KNIFE

LENGTH	STANDARD VERSION		HSS QUALITY VERSION	
410 mm	Art.: 4094	18,90 €	Art.: 4121	38,10 €
510 mm	Art.: 4095	27,20 €	Art.: 4122	44,90 €
520 mm	Art.: 4097	30,70 €	Art.: 4123	48,40 €
610 mm	Art.: 4119	32,80 €	Art.: 4125	55,20 €
630 mm	Art.: 4096	32,50 €	Art.: 4126	54,90 €
640 mm	Art.: 4098	33,60 €	Art.: 4127	58,80 €
810 mm	Art.: 4099	44,70 €	Art.: 4128	74,80 €

* for highest performance and long service life



BRASS WEDGE FOR THE TERSA KNIFE SHAFT

Accessory for changing the Tersa knives.

Brass wedge for Tersa cutter block **34,50 €**
Art.: 7003.0050 EACH



SELF-ACTING SWIVEL PROTECTION 1560

The accident-proof protection device for surface planers and combined surface and thickness planers. This device offers the benefit that the material to be processed is pressed against the fence independently. No adjustment is required and the device is space saving.

ca. 2,4kg	Size b = for planing width 410 mm Art.: 4111	612,20 € EACH
ca. 2,8kg	Size c = for planing width 510 mm Art.: 4112	623,20 € EACH



SPARE PARTS

FOR SWIVEL PROTECTION TYPE 1560

ca. 900g	Link carpet 410 mm Art.: 4182	144,70 € EACH
ca. 1,0kg	Link carpet 510 mm Art.: 4183	166,50 € EACH
ca. 600g	Pressing part 410 mm without mechanics Art.: 3446	165,90 € EACH
ca. 700g	Pressing part 510 mm without mechanics Art.: 3448	190,90 € EACH
	Gas spring 410 mm, 300 N Art.: 4702	52,00 € EACH
	Gas spring 510 mm, 400 N Art.: 4703	52,00 € EACH





ADJUSTABLE MAGNETIC PLANING KNIFE QUICK SETTING DEVICES 1533

With strong magnetic adhesion, the planing knife protrusion is accurate to 1/10 mm due to the fine adjustment. Suitable for all cutterhead diameters from 80 to 145 mm.

1 set = 2 pieces in a practical wooden bow

ca. 500 g

Adjustable magnetic planing knife setting devices
1533

Art.: 2004

213,20 €
2 PCS SET



SERVICE SET FOR HELICAL CUTTERHEADS

For cleaning and care of the helical cutterheads.

Delivered in a practical storage case:

- 1 litre resin solvent concentrate
- 1 steel cleaning brush, 1 brass cleaning brush
- 10 HM reversible knives 15x15x2,5mm
- 5 Torx screws M6x15
- 1 Torque wrench
- 2 bit inserts T20

Service set for helical cutterheads

Art.: 4647

215,00 €
EACH SET



SPARE BLADE FOR HELICAL CUTTERHEADS

10 pieces

Art.: 4641

57,00 €
EACH PU

96 pieces spare blades for helical cutterhead PANHANS 334 | 20

Art.: 4641.1

337,00 €
EACH PU

132 pieces spare blades for helical cutterhead PANHANS 335 | 20

Art.: 4641.2

505,00 €
EACH PU

162 pieces spare blades for helical cutterhead PANHANS 336 | 20

Art.: 4641.3

620,00 €
EACH PU

66 pieces WOODPECKER

Art.: 4641.7

253,00 €
EACH PU



10 PIECES SCREWS FOR SPARE KNIVES OF HELICAL CUTTERHEAD

Set of 10 screws, suitable for replacement blades of spiral cutterheads

10 pcs. screws for spare blades of helical cutterheads

Art.: 4642

19,00 €
EACH PU



SPARE BLADES FOR HELICAL CUTTERHEADS COMPLETE WITH SCREWS FOR PANHANS

Quantity adapted to helical cutterheads of PANHANS machines, with screws

included:

- 1x torque screwdriver
- 2x bits

96 pieces for type 334 | 20 **543,00 €**
EACH PU

132 pieces for type 335 | 20 **778,00 €**
EACH PU

162 pieces for type 336 | 20 **950,00 €**
EACH PU



SPARE BLADES FOR HELICAL CUTTERHEADS WOODPECKER SET WITH SCREWS

consisting of:

- 66 pieces knives & screws
- 1x Torque screwdriver
- 2x bits

Spare Blade for helical cutterhead WOODPECKER Set with screws **398,00 €**
EACH PU

Art.: 4641.8



TORQUE SCREWDRIVER 5.7 NM

Torque screwdriver 5.7 Nm **20,00 €**
EACH PU

Art.: 4641.9



2X BITS FOR TORX 1/4 INCH TX 20

2x Bits for Torx 1/4 inch TX 20 **4,90 €**
EACH PU

Art.: 4641.10

PLANING



CUTTERHEAD PRESSURE BARS

Balanced, with screws R 1/4", SW 17.



NOTICE: Supplied in pairs.

Length: 410 mm Art.: 4087	69,50 € PER PAIR
Length: 510 mm Art.: 4088	93,80 € PER PAIR
Length: 520 mm Art.: 4093	62,90 € PER PAIR
Length: 610 mm Art.: 4089	118,50 € PER PAIR
Length: 630 mm Art.: 4131	128,70 € PER PAIR
Length: 640 mm Art.: 4090	125,40 € PER PAIR
Length: 810 mm Art.: 4092	168,50 € PER PAIR



CUTTERHEAD SCREWS

Hardened, R 1/4", SW 17.

 ca. 20g	Standard version, height approx. 21 mm Art.: 4107	4,60 € EACH
 ca. 20g	WIGO version, height approx. 19 mm Art.: 4075	9,10 € EACH



WRENCH SW 17

For cutterhead screws with wrench size 17 mm.

 ca. 100g		
Wrench SW 17 Art.: 4113		12,10 € EACH



CUTTERHEAD PRESSURE SPRING

For lifting the knives and facilitate their precise setting with the magnetic knife setting devices (Art.: 2004).

 7,65x0,8x50mm		
Cutterhead pressure spring Art.: 4114		2,60 € EACH

RECOMMENDED ACCESSORY:

MAGNETIC PLANING KNIFE QUICK SETTING DEVICES | AT PAGE 22



THE NEW ONLINESHOP FOR WOOD CRAFTSMEN!

24 hours a day, 7 days a week, 365 days a year:

Now you can order conveniently from home or your workshop equipment, Machines, spare parts, consumables, accessories and much more
Order online without worrying about the telephone service hours.

Ordering at our Shop you can save time that you can spend in a better way.

**WITH THIS CODE
YOU SAVE 5,00 € ON YOUR
NEXT ORDER:**

SiTec-2021

VOUCHER CODE

PRACTICAL

AT ANY TIME

FAST

Redeemable once in our online shop until 31/12/2021
for your next order from a purchase value of € 50.00.
Cannot be combined with other discounts.

 www.hokubema.com

BAND SAWS



THE UNKNOWN BAND SAW WITH MANY USEFUL AND SIMPLE USER BENEFITS

The thin saw blade enables cuts at various angles. The sawing out of shapes as well as curved cuts can be carried out precisely with a band saw. The basis for all functional elements is the band saw guide APA. With its user-friendly fine adjustment, standard permanent lubrication and minimal maintenance, the APA guide ensures a smooth workflow and a long service life for the band saw blade.

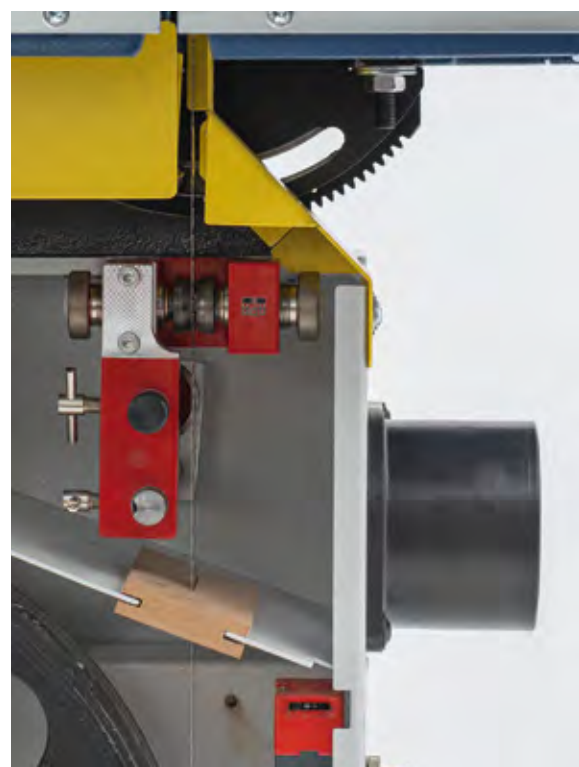



ABOUT US P.01

MILLING P.03

PLANING P.13

BAND SAWS P.27

CIRCULAR SAWS P.39

GENERAL P.49

LIFT TABLES P.55

ACCESSORIES P.63

APPENDIX P.73

BAND SAWS

HIGH-PERFORMING BAND SAW GUIDE APA 2	28
SPECIAL OIL 1059	28
SPARE PARTS FOR BAND SAW BLADE GUIDES APA 2	29
SPARE PARTS FOR BALL-BEARING BACK ROLLER	30
SPARE PARTS FOR BAND SAW BLADE GUIDE APA 1055	30
BAND SAW BLADE GUIDE GL	31
SPARE PARTS FOR GL BAND SAW BLADE GUIDE	31
RUBBER CORK BANDAGES 1011	32
POWER ADHESIVE 1014	32
SERVICE: WHEEL REPAIRS	33
ADDITIONAL PROTECTION COVER	34
TABLE EXTENSION FOR BAND SAW TABLES	34
KREISFIX	34
FASTENING RAILS	34
MDF INSERT BOARD	35
TABLE INSERT FOR MACHINE TABLE	35
WOODEN SLIDING STICK 2391	35
BAND SAW BLADES FOR WOODWORKING (FINISHED LENGTHS)	36
BAND SAW BLADES FOR WOODWORKING (CUSTOM-MADE LENGTHS)	37

BAND SAWS

HIGH-PERFORMING BAND SAW BLADE GUIDE APA 2

THE VERY HEART OF EVERY BAND SAW



HIGH-PERFORMING BAND SAW BLADE GUIDE APA 2

Standard version suitable for all band saws:

- Selected materials, optimized hardening processes and tight manufacturing tolerances stand for this technically high-quality product
- Hardened back and side rollers fix the saw blade in the correct position
- Hardened treads also guarantee years of work and are easy to change if necessary
- User-friendly fine adjustment, permanent lubrication as standard, minimal maintenance, stable construction
- Smooth and wear-free saw blade guidance
- Highest precision and long service life of the band saw blade
- Fixing elements included

ca. 1,1kg	Version Size 1 above For wheel diameter 300–500 mm Blade widths 3–25 mm Art.: 1248	216,80 € EACH
ca. 1,0kg	Version Size 1 below For wheel diameter 300–500 mm Blade widths 3–25 mm Art.: 1250	223,40 € EACH
ca. 2,1kg	Version Size 2 above For wheel diameter 600–900 mm Blade widths 5–40 mm Art.: 1254	264,60 € EACH
ca. 1,9kg	Version Size 2 below For wheel diameter 600–900 mm Blade widths 5–40 mm Art.: 1256	272,30 € EACH

High-performing band saw blade guide for processing of non-ferrous metals and difficult-to-machine wooden materials with ball-bearing back roller:

ca. 2,2kg	Version Size 2 above For wheel diameter 600–900 mm Blade widths 5–40 mm Art.: 1276	277,80 € EACH
ca. 2,0kg	Version Size 2 below For wheel diameter 600–900 mm Blade widths 5–40 mm Art.: 1277	296,50 € EACH



SPECIAL OIL 1059

For APA high-performing band saw blade guides, for the lubrication of the side and back rollers.

NOTICE: A regular lubrication increases considerably the service life of the APA band saw blade guide.

ca. 100g	5 bottles 20ml each	16,90 € EACH SET
Special oil 1059 Art.: 3215		

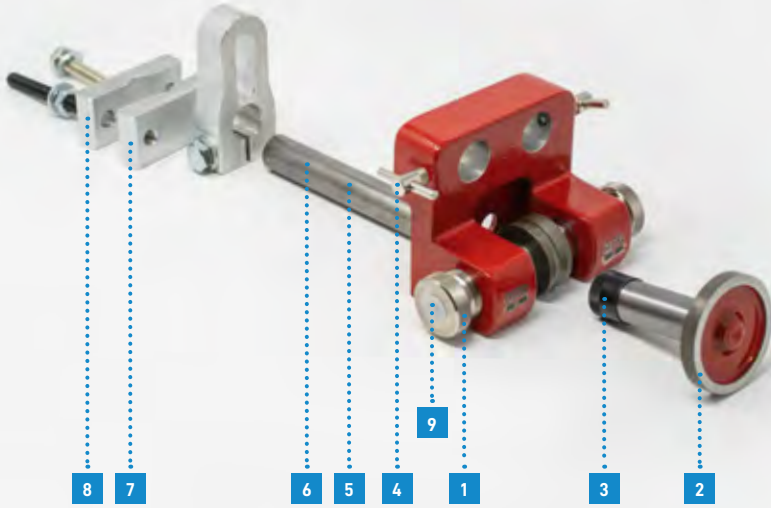

Upper band saw blade guide APA 2

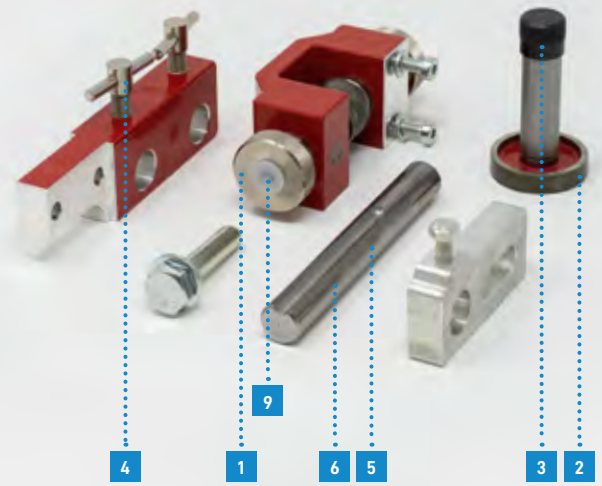

Lower band saw blade guide APA 2



SPARE PARTS

For band saw blade guides APA 2 upper and lower version.

TECHNICAL DATA	APA 2 Size 1	APA 2 Size 2
Back roller	ø 40 mm	ø 58 mm
Bearing sleeve	ø 16 mm	ø 22 mm
Back roller bolt	ø 8 mm	ø 10 mm
Side roller	ø 26 mm	ø 40 mm
Bolt	ø 8 mm	ø 10 mm
Bolt length	11 mm	22 mm

ATTENTION: When ordering spare parts always indicate the size of the band saw guide. It can be determined using the diameter of the upper or lower back or side roller.

	APA 2 Size 1	APA 2 Size 2
1 Side roller complete*	69,60 € EACH	86,30 € EACH
Art.: 1290		Art.: 1291
1 Side roller complete 2 pcs. set*	122,40 € 2 PCS SET	155,00 € 2 PCS SET
Art.: 1292		Art.: 1293
2 Back roller top, complete**	65,70 € EACH	73,90 € EACH
Art.: 1046		Art.: 1047
2 Back roller bottom, complete**	64,30 € EACH	79,20 € EACH
Art.: 1052		Art.: 1053
3 Locking cap	3,80 € EACH	3,80 € EACH
Art.: 1097		Art.: 1099
4 Tommy screw	3,70 € EACH	3,70 € EACH
Art.: 1182		Art.: 1182
5 Support bolt 16 x 120 mm***	19,10 € EACH	
Art.: 1146		
6 Support bolt 22 x 120 mm***		19,50 € EACH
		Art.: 1270
7 Clamp front	12,40 € EACH	12,40 € EACH
Art.: 1268		Art.: 1268
8 Clamp rear	11,90 € EACH	11,90 € EACH
Art.: 1269		Art.: 1269
9 Locking plug	1,90 € EACH	1,90 € EACH
Art.: 1265		Art.: 1265

* with bearing sleeve and locking plug

** with bearing sleeve and locking cap

*** also available in other lengths

BAND SAWS



Ball-bearing back roller K/2 top maintenance free



Ball-bearing back roller K/3 top maintenance free



Spare running tread K/1 with screws

SPARE PARTS FOR BALL-BEARING BACK ROLLER

Suitable for cutting non-ferrous metals and difficult-to-machine wooden materials.

Ball-bearing back roller K/2 top maintenance free

ca. 400g	APA 1055 Size III APA 2 Size 2 Art.: 1168	183,70 € EACH
ca. 500g	APA 1055 Size IV Art.: 1169	219,50 € EACH
ca. 900g	APA 1055 Size VI Art.: 1170	229,50 € EACH

Ball-bearing back roller K/3 bottom maintenance free

ca. 400g	APA 1055 Size III APA 2 Size 2 Art.: 1171	183,70 € EACH
ca. 500g	APA 1055 Size IV Art.: 1172	225,60 € EACH
ca. 900g	APA 1055 Size VI Art.: 1173	184,10 € EACH

Spare running tread K/1 with screws

ca. 50g	APA 1055 Size III Art.: 1174	39,30 € EACH
ca. 80g	APA 1055 Size IV Art.: 1175	59,90 € EACH
ca. 160g	APA 1055 Size VI Art.: 1176	71,60 € EACH

SPARE PARTS FOR BAND SAW BLADE GUIDES APA 1055 (NOT FOR APA 2)



Upper or lower back roll



Side roller with side locking screw including locking plug

TECHNICAL DATA	APA 1055 Size 0	APA 1055 Size I	APA 1055 Size II	APA 1055 Size III	APA 1055 Size IV	APA 1055 Size VI
Back roller	ø 28 mm	ø 35 mm	ø 40 mm	ø 58 mm	ø 65 mm	ø 78 mm
Back roller bearing	ø 16 mm	ø 16 mm	ø 16 mm	ø 22 mm	ø 24 mm	ø 30 mm
Back roller bolt	ø 8 mm	ø 8 mm	ø 8 mm	ø 10 mm	ø 12 mm	ø 14 mm
Side roller	ø 22 mm	ø 26 mm	ø 35 mm	ø 40 mm	ø 48 mm	ø 65 mm
Side bearing sleeve	ø 22 mm	ø 16 mm	ø 16 mm	ø 22 mm	ø 24 mm	ø 28 mm
Side roller bolt	ø 8 mm	ø 8 mm	ø 8 mm	ø 10 mm	ø 10 mm	ø 12 mm
Upper back roller *	66,10 € Art.: 1044	62,30 € Art.: 1045	65,70 € Art.: 1046	73,90 € Art.: 1047	116,10 € Art.: 1048	71,70 € Art.: 1049
Lower back roller *		65,70 € Art.: 1051	69,50 € Art.: 1052	79,10 € Art.: 1053	80,90 € Art.: 1054	108,90 € Art.: 1055
Side roller **	68,20 € Art.: 1064	54,70 € Art.: 1065	50,50 € Art.: 1066	85,60 € Art.: 1067	83,90 € Art.: 1068	105,90 € Art.: 1069
Locking cap top and bottom		3,70 € Art.: 1097	3,60 € Art.: 1097	3,80 € Art.: 1099	8,80 € Art.: 1100	16,10 € Art.: 1101
Side locking screw incl. locking plug		8,50 € Art.: 1091	8,50 € Art.: 1091	12,10 € Art.: 1093	11,50 € Art.: 1094	19,70 € Art.: 1095
Tommy screw long (the same for sizes 0 to VI)						3,70 € Art.: 1181
Tommy screw short the same for sizes 0 to VI)						3,70 € Art.: 1182

* with bearing sleeve and locking cap

** with bearing sleeve and locking screw incl. locking plug

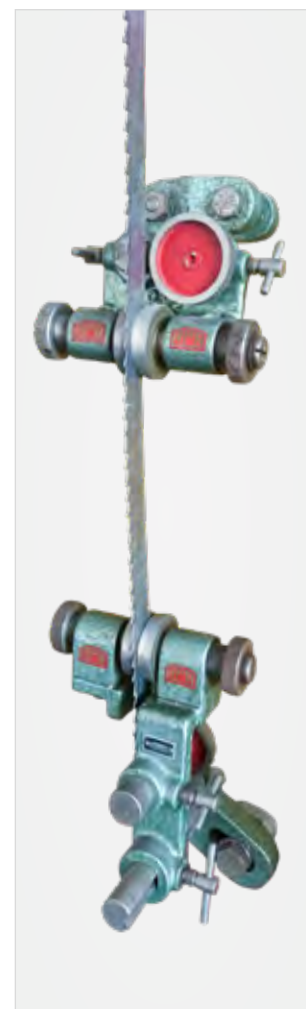

BAND SAW BLADE GUIDE GL





PRECISION GUIDE FOR BAND SAWS



BAND SAW BLADE GUIDE GL

Standard version suitable for all band saws:

- Precise guidance of the band saw blade
- Easy to use
- Permanent lubrication as standard
- Low maintenance requirements
- Enormous service life of the wear elements
- Smooth and wear-free saw blade guidance
- Fixing elements included

 ca. 1,1kg	Version 456 top For wheel diameter 400–600 mm Blade widths 3–25 mm Art.: 1300	143,50 € EACH
 ca. 1,0kg	Version 456 bottom For wheel diameter 400–600 mm Blade widths 3–25 mm Art.: 1301	135,50 € EACH
 ca. 2,1kg	Version 789 top For wheel diameter 700–800 mm Blade widths 5–40 mm Art.: 1302	149,30 € EACH
 ca. 1,9kg	Version 789 bottom For wheel diameter 700–800 mm Blade widths 5–40 mm Art.: 1303	144,30 € EACH
 ca. 5,1kg	Version 910 top For wheel diameter 900–1050 mm Blade widths 5–40 mm Art.: 1304	499,90 € EACH

NOTICE: Lower band saw blade guide for version 910 please use „Version 789 bottom“ Art. 1303.

SPARE PARTS

For GL band saw blade guide.

Back roller GL 456 (usable above and below) Bolt diameter 20 mm, roller diameter 35 mm Art.: 1306	35,80 € EACH
Side roller GL 456 (usable above and below) With bearing support Art.: 1307	62,50 € EACH
Back roller GL 789 (usable above and below) Bolt diameter 20 mm, roller diameter 50 mm Art.: 1308	41,90 € EACH
Side roller GL 789 (usable above and below) With bearing support Art.: 1309	70,40 € EACH
Back roller GL 910 (usable above) Bolt diameter 30 mm, roller diameter 70 mm Art.: 1310	98,80 € EACH
Side roller GL 910 (usable above) With bearing support Art.: 1311	140,30 € EACH



Back roller
(in the picture:
GL 910)



Side roller

BAND SAWS



RUBBER CORK BANDAGES 1011

For covering the band saw wheels and for easy repair of worn treads. Ensures a smooth run, a clean cut and extends the life of the band saw blade.

On request we can assemble the rubber cork bandages in the appropriate length for your band saw (please specify wheel diameter).

NOTICE: For cutting to size we calculate a surcharge of 5,—Euro.

ca. 100g Supply by the meter

Width: 20 mm Art.: 3600.20	7,10 € PER METER
Width: 25 mm Art.: 3600.25	7,60 € PER METER
Width: 30 mm Art.: 3600.30	8,90 € PER METER
Width: 35 mm Art.: 3600.35	12,40 € PER METER
Width: 40 mm Art.: 3600.40	12,60 € PER METER
Width: 45 mm Art.: 3600.45	13,80 € PER METER
Width: 50 mm Art.: 3600.50	16,10 € PER METER
Width: 55 mm Art.: 3600.55	16,90 € PER METER
Width: 60 mm Art.: 3600.60	18,80 € PER METER
Width: 65 mm Art.: 3600.65	21,70 € PER METER
Width: 70 mm Art.: 3600.70	23,70 € PER METER
Width: 80 mm Art.: 3600.80	33,60 € PER METER



POWER ADHESIVE 1014

Recommended accessory for gluing of rubber cork bandages on band saw wheels.

NOTICE: 1 can (approx. 650 g) is enough for 3 bandages up to ø 800 mm.

ca. 650g

Power adhesive 1014 Art.: 3213	30,90 € EACH
--	------------------------



Watch user video:
<https://www.youtube.com/watch?v=LlyWNaE2Nii>

WHEEL REPAIRS

The deflection wheel of your bandsaw is worn out and you would like to have it repaired?

As part of our services, we offer you comprehensive wheel repairs for your band saw wheels in sizes \varnothing 400–900 mm from **any manufacturer**. For this we bring your two wheels directly to our production facility in Sigmaringen (DE), we vulcanize, balance and camber them and have them delivered back to you.

THAT'S HOW IT WORKS:

1 HOW TO ASK FOR SERVICE

Contact our Customer service department and ask for the the service you need:

☎ **SERVICE:** +49 (0)7571 755-121

📱 **WHATSAPP:** +49 (0) 174 2137344

✉ **E-MAIL:** service@hokubema-panhans.de

We report the collection of your bandsaw wheels to the shipping company.

2 DISMOUNTING

Remove the wheels of your band saw and pack them on a pallet. (If necessary, see the instructions from your manufacturer.)

3 VULCANIZATION, CALIBRATION AND CAMBERING

Within a few days we will repair your wheels in our factory.

4 RETURN DELIVERY

Once repaired, we will your wheels back to you.

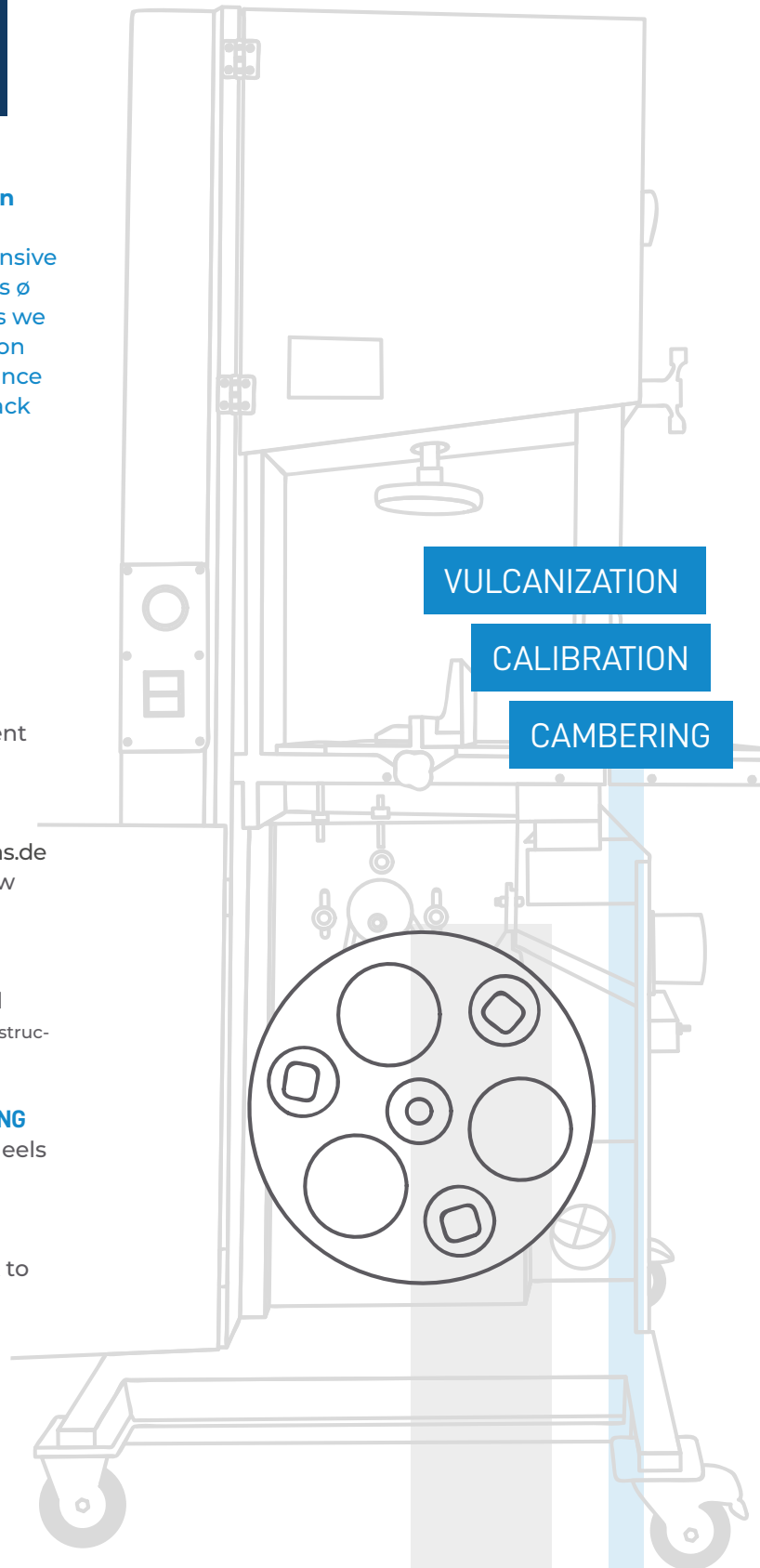

MANUFACTURER:
Regardless
(all manufacturers)



PICK-UP SERVICE:
By carrier through
durch HO|KU|BE|MA



REPAIR TIME:
Only 5 days
without band saw

from **300,00 €**

WHEEL REPAIR including collection and return service, within 5 days you will have your wheels back, regardless of their manufacturer.*

Price varies depending on size and location

BAND SAWS

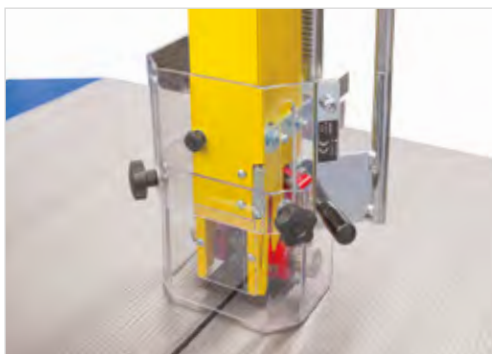

ADDITIONAL PROTECTION COVER FOR BAND SAW BLADE GUIDES

The two-part, transparent protective shield is adjustable in height and can be swung away to change the blade. As a further addition to the standard protective device for optimum safety between the tabletop and band saw blade guide.

Additional protection cover
Art.: 1209

738,50 €
EACH



TABLE EXTENSION FOR BAND SAW TABLES

To fix to the fastening rail of the table.

- Table in anodized aluminium
- Foldable supporting foot

Without fastening rail (Art.: 3057 – 3060)

NOTICE: Replaces an assistant when machining long workpieces.

✂ 1100x172mm (LxW)

Table extension
Art.: 1351

211,80 €
EACH



KREISFIX

Practical help when sawing round workpieces. Enables precise sawing of arches and discs without scribing. For workpieces with large diameters, the use of a second table extension is recommended.

Without fastening rail (Art.: 3057 – 3060)

ATTENTION: Kreisfix can be easily mounted on the table extension (Art.: 1351).

Kreisfix
Art.: 1350

93,50 €
EACH



FASTENING RAILS

Universal basic element for holding safety and working devices on band saws.

330 mm long
Art.: 3057

18,20 €
EACH

430 mm long
Art.: 3058

19,50 €
EACH

530 mm long
Art.: 3059

22,20 €
EACH

830 mm long
Art.: 3060

26,60 €
EACH



MDF INSERT BOARD

The insert board is placed in the chip duct below the lower band saw guide. This prevents wood splinters from getting between the band saw wheel and the band saw blade.

For band saw wheel diameter 400 mm und 800 mm

Format: 105 x 60 mm
Art.: 0005.0710

7,50 €
EACH

For band saw wheel diameter 500 mm, 600 mm, 700 m

Format: 96 x 60 mm
Art.: 0005.0711

7,50 €
EACH

For band saw wheel diameter 900 mm

Format: 140 x 60 mm
Art.: 0005.0712

7,70 €
EACH



TABLE INSERT FOR MACHINE TABLE

Reduces table opening to a minimum – including stud bolts.

NOTICE: Due to the dimensional tolerances of the cast table tops, the table inserts must be fitted on site.

For band saw wheel diameter 400 mm

Format: 83 x 83 mm
Art.: 0345.5102

32,60 €
EACH

For band saw wheel diameter 500 mm, 600 mm, 700 m

Format: 85 x 65 mm
Art.: 0345.5103

17,60 €
EACH

For band saw wheel diameter 800 mm, 900 mm

Format: 100 x 80 mm
Art.: 0345.5104

18,20 €
EACH



WOODEN SLIDING STICK 2391

With fixing magnet for storage on the metal machine body. Serves to safely guide narrow workpieces on table and sliding table saws, thus reducing the risk of accidents.

Wooden sliding stick 2391 (packaging: 1 piece)

Art.: 3416

9,60 €
EACH

Wooden sliding stick 2391 (packaging: 5 pieces)

Art.: 3417

40,90 €
PACK.: 5 PCS

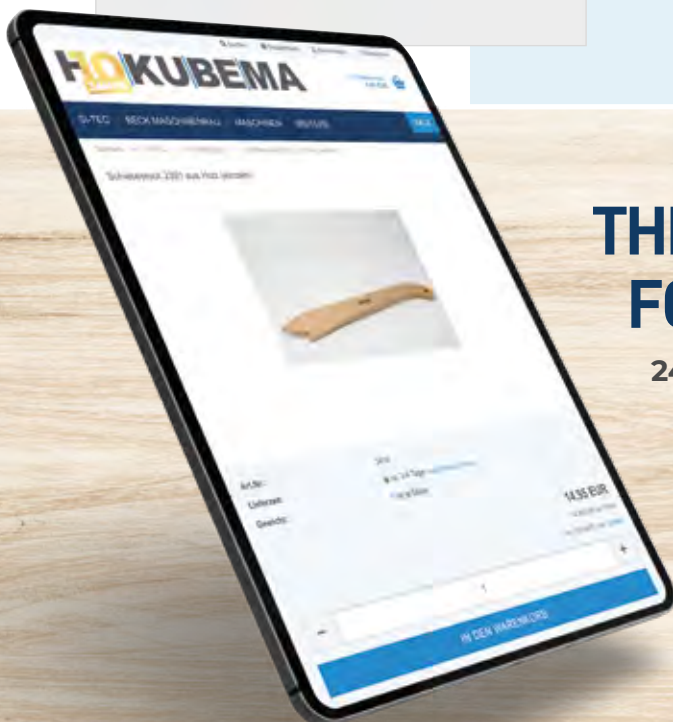

THE NEW ONLINESHOP FOR WOOD CRAFTSMEN!

24 hours a day, 7 days a week, 365 days a year:

Now you can order equipment, machines, spare parts, consumables, accessories and much more online from the comfort of your home or workshop – without the hassle of opening hours:

 www.hokubema.com

BAND SAWS

BAND SAW BLADES FOR WOODWORKING

FINISHED LENGTHS

For PANHANS band saws of the present series (also Rapid, N'RA, Cosma and Eumacop).

NOTICE: The exact blade length can be found on the nameplate of your machine.

BLADE LENGTH	WIDTH	THICKNESS	TOOTH WIDTH	QUALITY		
BSB 400						
3330 mm	20	0,45 mm	6	1002	Art.: 3783.20G	29,70 €
3330 mm	15	0,45 mm	6	1002	Art.: 3783.15G	31,60 €
3330 mm	10	0,40 mm	6	1002	Art.: 3783.10G	29,90 €
BSB 500						
4140 mm	25	0,45 mm	7	1002	Art.: 3783.25K	44,20 €
4140 mm	20	0,45 mm	6	1002	Art.: 3783.20K	35,50 €
4140 mm	15	0,45 mm	6	1002	Art.: 3783.15K	32,90 €
4140 mm	10	0,40 mm	6	1002	Art.: 3783.10K	31,60 €
BSB 600						
4735 mm	25	0,60 mm	9	1000	Art.: 3780.250D	38,30 €
4735 mm	20	0,70 mm	8	1000	Art.: 3780.20D	35,60 €
4735 mm	10	0,70 mm	6	1000	Art.: 3780.10D	34,20 €
BSB 700						
5140 mm	35	0,80 mm	10	1000	Art.: 3780.35F	44,10 €
5140 mm	30	0,80 mm	9	1000	Art.: 3780.30F	45,50 €
5140 mm	25	0,70 mm	9	1000	Art.: 3780.25F	44,10 €
5140 mm	20	0,70 mm	8	1000	Art.: 3780.20F	39,70 €
5140 mm	15	0,70 mm	7	1000	Art.: 3780.15F	39,70 €
BSB 800						
5775 mm	40	0,80 mm	12	1001	Art.: 3781.40I	49,90 €
5775 mm	35	0,80 mm	10	1000	Art.: 3780.35I	49,90 €
5775 mm	30	0,80 mm	9	1000	Art.: 3780.30I	49,90 €
5775 mm	25	0,70 mm	9	1000	Art.: 3780.25I	48,40 €
5775 mm	20	0,70 mm	8	1000	Art.: 3780.20I	45,10 €
5775 mm	15	0,70 mm	7	1001	Art.: 3781.15I	41,90 €
BSB 900						
6260 mm	40	0,80 mm	12	1001	Art.: 3781.40L	66,60 €
6260 mm	35	0,80 mm	10	1000	Art.: 3780.35L	59,50 €
6260 mm	30	0,80 mm	9	1000	Art.: 3780.30L	54,80 €
6260 mm	25	0,70 mm	9	1000	Art.: 3780.25L	53,90 €
6260 mm	20	0,70 mm	8	1001	Art.: 3781.20L	51,40 €
6260 mm	15	0,70 mm	7	1001	Art.: 3781.15L	46,20 €

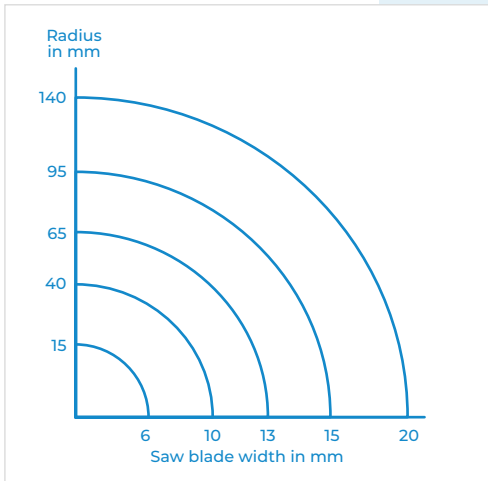

Width of the saw blade

The width of the saw blade depends on the radius to be sawn:
The narrower the radius, the narrower the saw blade.

**MINIMUM
PURCHASE:
3 PIECES**

CUSTOM-MADE LENGTHS

The recommended band saw blade thickness is 1/1000 of the wheel diameter. With a wheel diameter of 600mm, this corresponds to a blade thickness of 0.6mm. Please always indicate the sheet length.

NOTICE: The exact belt length can be found on the nameplate of your machine. Minimum quantity 3 pieces per length. These goods are sold per meter (delivery ready to cut). Band saw blades are made to customer specifications and are exempt from exchange or return.

QUALITY NO. 1002 – UP TO WHEEL DIAMETER 600 MM

In special steel for woodworking. High endurance.

WIDTH	THICKNESS	TOOTH WIDTH		
6 mm	0,40 mm	4 mm	Art.: 3767.06	8,80 €
10 mm	0,40 mm	6 mm	Art.: 3767.10	8,20 €
10 mm	0,60 mm	6 mm	Art.: 3767.101	8,20 €
15 mm	0,45 mm	6 mm	Art.: 3767.15	8,60 €
15 mm	0,60 mm	6 mm	Art.: 3767.150	9,20 €
20 mm	0,45 mm	6 mm	Art.: 3767.20	9,80 €
25 mm	0,45 mm	7 mm	Art.: 3767.25	12,60 €
25 mm	0,45 mm	8 mm	Art.: 3767.250	12,60 €

QUALITY NO. 1000 – FROM WHEEL DIAMETER 600 MM

In special steel for woodworking. High endurance.

WIDTH	THICKNESS	TOOTH WIDTH		
10 mm	0,70 mm	6 mm	Art.: 3415.10	7,80 €
20 mm	0,70 mm	8 mm	Art.: 3415.20	8,90 €
25 mm	0,70 mm	9 mm	Art.: 3415.25	9,60 €
25 mm	0,60 mm	9 mm	Art.: 3415.250	11,00 €
30 mm	0,80 mm	9 mm	Art.: 3415.30	11,80 €
35 mm	0,80 mm	10 mm	Art.: 3415.35	14,40 €

QUALITY NO. 1001 – FROM WHEEL DIAMETER 600 MM

Original Swedish Uddeholm steel for woodworking. High endurance.

WIDTH	THICKNESS	TOOTH WIDTH		
6 mm	0,60 mm	6 mm	Art.: 3434.06	8,40 €
8 mm	0,70 mm	6 mm	Art.: 3434.08	8,60 €
10 mm	0,70 mm	6 mm	Art.: 3434.10	8,80 €
12 mm	0,70 mm	6 mm	Art.: 3434.12	9,10 €
15 mm	0,70 mm	7 mm	Art.: 3434.15	9,30 €
20 mm	0,70 mm	8 mm	Art.: 3434.20	9,50 €
25 mm	0,70 mm	9 mm	Art.: 3434.25	10,30 €
30 mm	0,80 mm	9 mm	Art.: 3434.30	10,40 €
35 mm	0,80 mm	10 mm	Art.: 3434.35	15,20 €
40 mm	0,80 mm	12 mm	Art.: 3434.40	17,50 €

QUALITY NO. 1005 – FROM WHEEL DIAMETER 400 MM

In special steel with high endurance and hardened tooth tips for the working of wood, chipboard, plastics etc. Band saw blades of type 1005 cannot be retightened.

WIDTH	THICKNESS	TOOTH WIDTH		
10 mm	0,40 mm	6 mm	Art.: 3972.100	11,20 €
10 mm	0,70 mm	6 mm	Art.: 3972.10	11,20 €
15 mm	0,45 mm	6 mm	Art.: 3972.150	11,90 €
15 mm	0,60 mm	6 mm	Art.: 3972.151	11,90 €
15 mm	0,70 mm	7 mm	Art.: 3972.15	11,90 €
20 mm	0,45 mm	6 mm	Art.: 3972.200	12,40 €
20 mm	0,60 mm	6 mm	Art.: 3972.201	12,40 €
20 mm	0,70 mm	8 mm	Art.: 3972.20	12,40 €
25 mm	0,70 mm	9 mm	Art.: 3972.25	13,40 €

CIRCULAR SAWS

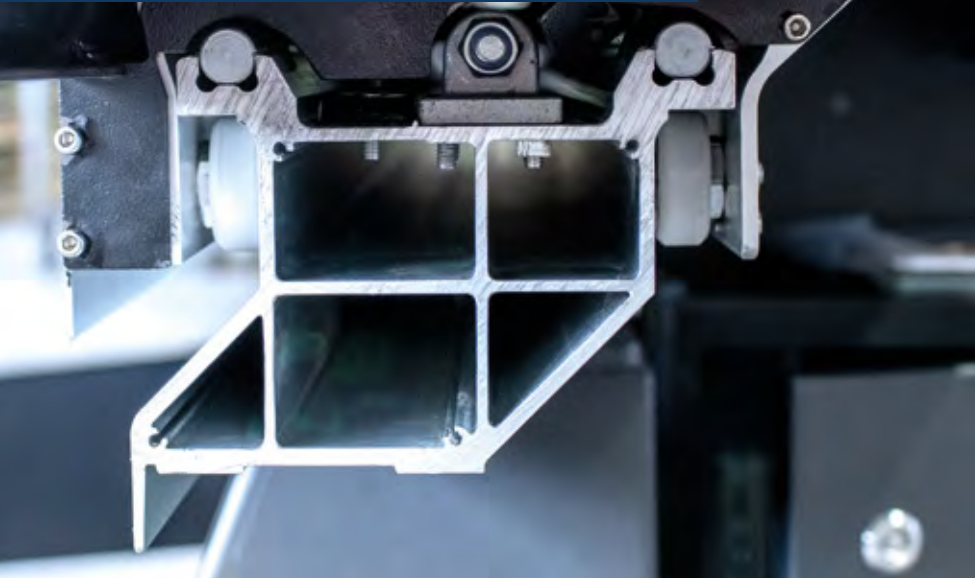

KNOW-HOW, EXPERIENCE AND QUALITY FOR OPTIMAL WORK IN THE WORKSHOP

As usual, the sliding table saw can be used to shape wood, plastic or similar materials. The safety products from our SI-TEC catalogue make this work easier with some interesting developments and thus ensure more safety and economy. Technology developed from experienced know-how and developed according to the needs of experienced wood craftsmen.

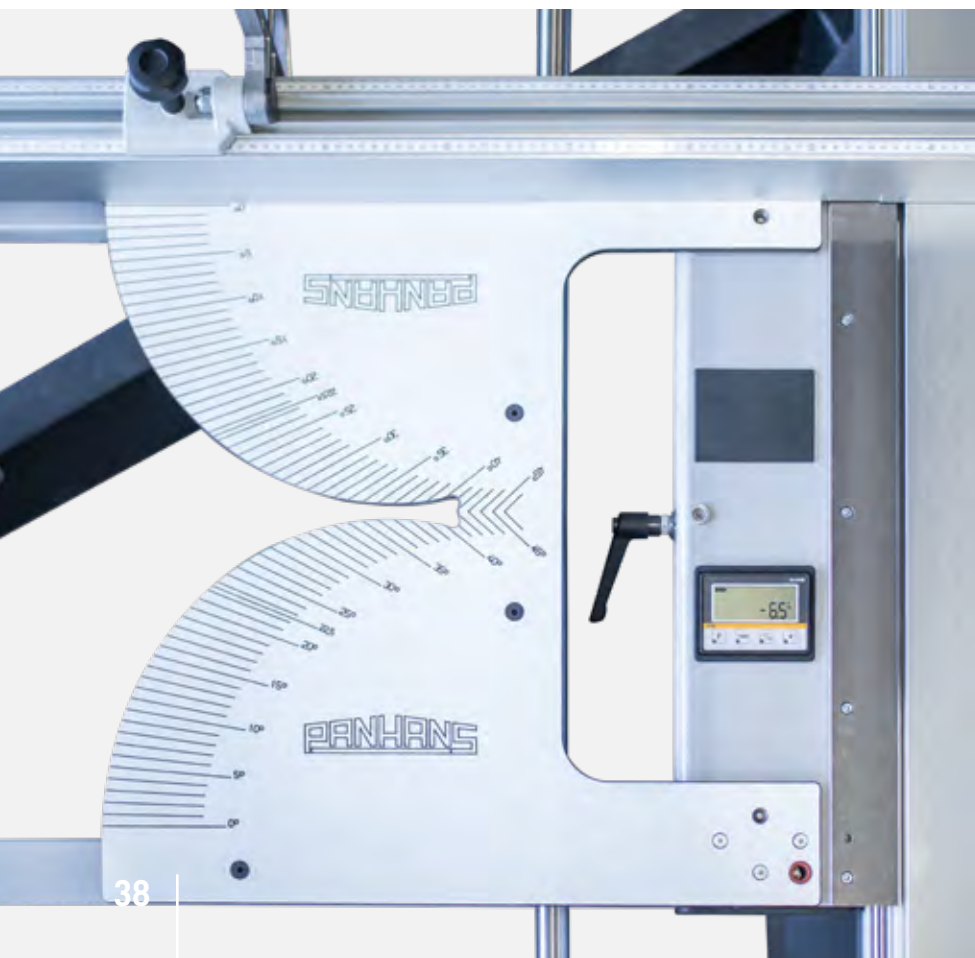



ABOUT US P.01

MILLING P.03

PLANNING P.13

BAND SAWS P.27

CIRCULAR SAWS P.39

GENERAL P.49

LIFT TABLES P.55

ACCESSOIRES P.63

APPENDIX P.73

CIRCULAR SAWS

CIRCULAR SAW FEEDER 76	40
ACCESSORIES FOR CIRCULAR SAW FEEDER 76	40
SIMPLY WORKPIECE HOLDER	41
CROSSCUT FENCE 617	41
SLIDING HANDLE 2390	41
CIRCULAR SAW PROTECTION DEVICE 1773F	42
PROTECTION HOOD, NARROW, WITH FASTENING BAR	42
PROTECTION HOOD, WIDE, WITH FASTENING BAR	43
ACCESSORIES FOR CIRCULAR SAW PROTECTION DEVICE 1773F	43
PROTECTION HOOD WITH EXTRACTION CONNECTION 1798	43
DOUBLE-SIDED MITRE FENCE DSG-A	44
DOUBLE-SIDED MITRE FENCE DSG-D	44
SAFETY-CUT	45
SAFETY-CUT PLUS	45
SAFETY-POWER	45
MULTI-CUT	45
CLAMP FOR SLIDING TABLE	45
FORCED-GUIDED RIVING KNIVES FOR SAWS Ø 100 – 250 MM	46
FORCED-GUIDED RIVING KNIVES FOR SAWS Ø 250 – 350 MM	46
FORCED-GUIDED RIVING KNIVES FOR SAWS Ø 350 – 450 MM	46
FORCED-GUIDED RIVING KNIVES FOR SAWS Ø 500 – 600 MM	46
PANHANS RIVING KNIVES FOR SAWS Ø 100 – 250 MM	47
PANHANS RIVING KNIVES FOR SAWS Ø 200 – 300 MM	47
PANHANS RIVING KNIVES FOR SAWS Ø 300 – 315 MM	47

CIRCULAR SAWS

CIRCULAR SAW-FEEDER 76

SUITABLE FOR ALL
SLIDING TABLE SAWS
ANY MANUFACTURER

Can be used on table and sliding table saws of various makes. Serves for the safe cutting of strips, planks, window scantlings etc. in solid wood. Equipped with an adjustable mounting profile, 3 feed rollers and 2 feed speeds. The quick adjustment to the workpiece height is made by handwheel. Extraction connection for dust-free work, including plug, with rail for mounting heights of 18–40 mm and clamping plate on the rip fence of 20–30 mm, as well as with an integrated electrical safety magnet system to prevent tipping.

Simple and fast (tool free) assembly/disassembly on the rip fence instead of the aluminium profile. Best view on the workpiece thanks to a transparent swivelling cover, ergonomic work when cutting strips.

TECHNICAL DATA

Drive rollers	3 pcs
Rollers	ø 110 mm
Roller thickness front	50 mm
Roller thickness middle	20 mm
Roller thickness rear	50 mm
Centre distance	200 mm
Infeed speed	13 + 26 m/min
Drive	0,14 kW
Workpiece height max.	80 mm
Workpiece length min.	200 mm
Extraction nozzle	80 mm



Circular saw feeder 76: Infeed roller in detail

CIRCULAR SAW FEEDER 76

ca. 30,0kg 400 V / 50 Hz

Circular saw feeder 76 **3.789,00 €**
Art.: 2078 EACH

ACCESSORIES

ca. 100g **Infeed roller 110 x 20 mm** **56,80 €**
(middle roller)
Art.: 4101 EACH

ca. 100g **Infeed roller 110 x 50 mm** **79,30 €**
(front and rear roller)
Art.: 4102 EACH

Adapter rail **50,90 €**
for Altendorf sliding table saws
Art.: 6209.0048 EACH

Adapter rail **66,30 €**
for fixing height 30–40 mm and clamp
plate on the fence 30–50 mm
Art.: 2067 EACH



Watch user video:
https://www.youtube.com/watch?v=eW_VC4tgbLQ



SIMPLY WORKPIECE HOLDER

For safe and clean lengthwise cutting of narrow parts. With a spring-loaded roller \varnothing 80 mm, it can be easily mounted on the aluminium profile of the circular saw fence via star handles. The roller is adjustable in the height for individual adaptation to the workpiece thickness. The SIMPLY workpiece holder should be used in pairs.

SIMPLY workpiece holder
Art.: 2082

187,90 €
PRO STÜCK



CROSSCUT FENCE 617

For circular saws with swivel arm of aluminium profile with telescopic extension, colour scales, optical magnification for a precise scale reading. Crosscut fence extensible up to 2500 mm fence length, with 2 spring-loaded adjustable stop catches.

ca. 8,2kg

Extensible up to 2.500mm

Crosscut fence 617
Art.: 2009

473,00 €
EACH



SLIDING HANDLE 2390

To prevent accidents on circular saws, planing machines, etc. The shape of self-made wood blocks can be individually adapted to the workpiece. Tips penetrating deep into the wood guarantee that the handle is held securely.

ca. 600g

Sliding handle 2390 single
Art.: 3328

19,30 €
EACH

Sliding handle 2390 set of 2 pieces
Art.: 3327

32,20 €
SET OF 2 PCS

Sliding handle 2390 set of 5 pieces
Art.: 3330

79,90 €
SET OF 5 PCS

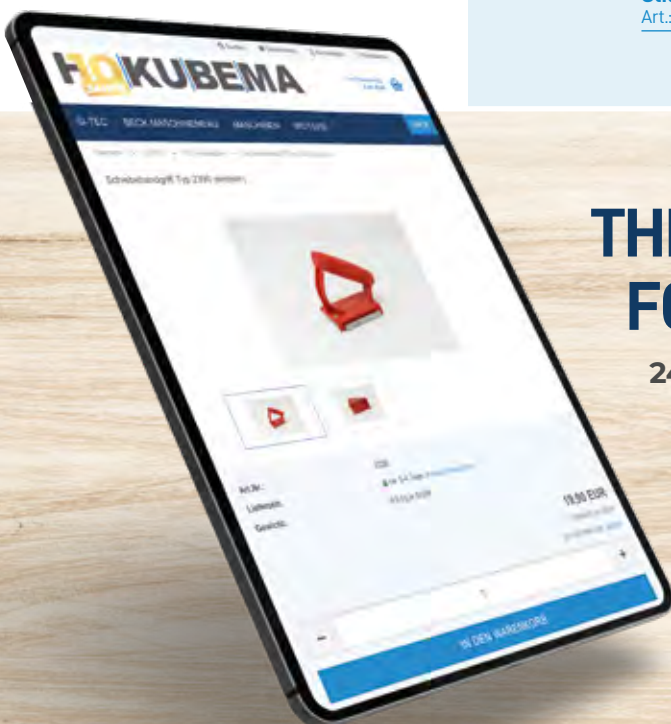

THE NEW ONLINESHOP FOR WOOD CRAFTSMEN!

24 hours a day, 7 days a week, 365 days a year:

Now you can order equipment, machines, spare parts, consumables, accessories and much more online from the comfort of your home or workshop – without the hassle of opening hours:

www.hokubema.com

CIRCULAR SAWS

PROTECTIVE HOODS - FOR ALL SIZE CIRCULAR SAWS



We continue to sell the well-known protective hoods for all sliding table saws. You can also retrofit your existing sliding table saw with our safety hoods.

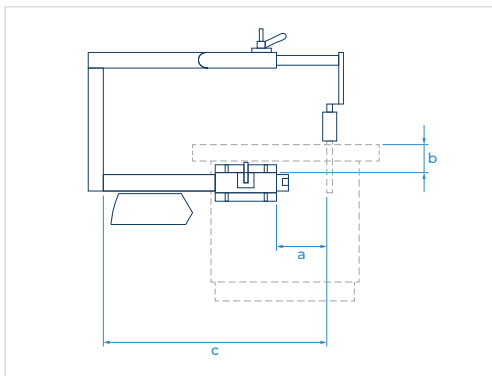



CIRCULAR SAW PROTECTION DEVICE 1773F

For an easy mounting on existing circular saws.

DIMENSIONS TABLE	Size 1	Size 2
a	min. 95 mm max. 640 mm	min. 355 mm max. 940 mm
b	optimal: 120 mm	optimal: 195 mm
c = Cutting width	450-850 mm	900-1250 mm

NOTICE: In accordance with the machinery directive, a protective device independent from the riving knife must be used for a saw blade diameter over 315 mm.

 ca. 17,5kg	Size 1 (for small circular saws) Set consisting of: Hood carrier, U attachment adjustable from 450 to 850 mm cutting width, with narrow protective hood and transparent cover, for saw blades up to \varnothing 300 mm and extraction nozzle \varnothing 80 mm, including adapter Art.: 2056	1.249,00 € EACH
 ca. 27,5kg	Size 2 (for sliding table saws) Set consisting of: Hood carrier, U attachment adjustable from 800 to 1250 mm cutting width with narrow protective hood and transparent cover, for saw blades up to \varnothing 400 mm and extraction nozzle \varnothing 80 mm, including adapter Art.: 2080	1.374,00 € EACH



PROTECTION HOOD, NARROW, WITH FASTENING BAR FOR CIRCULAR SAWS WITH FIXED BLADE

 ca. 1,6kg	For saw blades up to \varnothing 300 mm Art.: 2064	157,90 € EACH
 ca. 2,3kg	For saw blades up to \varnothing 400 mm Art.: 2065	169,50 € EACH

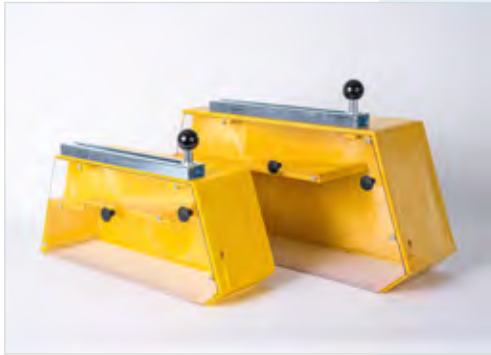

PROTECTION HOOD, WIDE, WITH FASTENING BAR FOR SAW BLADES WITH TILTING BLADE

ca. 2,1kg	For saw blades up to \varnothing 300 mm Art.: 2026	185,50 € EACH
ca. 3,5kg	For saw blades up to \varnothing 400 mm Art.: 2028	199,80 € EACH



Pluggable
Extraction nozzle



Feed roller for pro-
tection hood



Parallelogram



ACCESSORIES

FOR CIRCULAR SAW PROTECTION DEVICE 1773F AND RELATED PROTECTION HOODS.

ca. 200 g	Pluggable extraction nozzle \varnothing 80 mm suitable for narrow and wide protection hood Art.: 2081	54,00 € EACH
ca. 200 g	Feed roller for the protection hood complete \varnothing 400 mm Art.: 2021	31,20 € EACH
ca. 200 g	Feed roller for the protection hood complete \varnothing 300 mm Art.: 2020	31,20 € EACH
ca. 3,9kg	Parallelogram Size 1 for type 1773F Art.: 2058	384,00 € EACH
ca. 6,6kg	Parallelogram Size 2 for type 1773F Art.: 2070	605,90 € EACH
	Front protective lid, transparent for circular saw blade up to \varnothing 300 mm Art.: 2034	72,00 € EACH
	Front protective lid, transparent for circular saw blade up to \varnothing 400 mm Art.: 2031	73,90 € EACH
	Gas spring for parallelogram size 1 Art.: 0345.0209	137,90 € EACH
	Gas spring for parallelogram size 1 Art.: 0345.0208	121,80 € EACH

PROTECTION HOOD WITH EXTRACTION CONNECTION 1798

To be fixed to the riving knife.

ca. 700g	For circular saw blades up to \varnothing 315 mm Hose: \varnothing 60 mm Art.: 3301	40,20 € EACH
----------	---	------------------------

CIRCULAR SAWS

RIVING KNIVES FOR CIRCULAR SAW BLADES

For the fast and continuous production of mitre cuts on narrow and short workpieces at any angle from 0° – 90°. For cutting up to 1375 mm. Easy handling and quick assembly on the sliding table of the saw. With splinter wood and practical wall bracket.

A new feature is a printed scale, which also allows to obtain bevel squares easily. The length compensation for preferred angles 5° / 10° / 15° / 22,5° / 30° / 45° / 60° / 67,5° takes place automatically.



DOUBLE-SIDED MITRE FENCE DSG-A ANALOGIC

Angle and length dimension can be adjusted **analogically**. Includes adapter.

PANHANS 680_10_20	Art.: 5059	1.358,00 €*
PANHANS 690, V 91	Art.: 4389	1.468,00 €*
PANHANS 680_100_200	Art.: 5074	1.468,00 €*
Altendorf F 45, WA 8, WA 80	Art.: 4386	1.418,00 €*
Holzher Superslide 1245, 1290	Art.: 5053	1.109,00 €*
Holzskraft formal S	Art.: 5055	1.169,00 €*
Holzskraft SI 400 elite S	Art.: 5057	1.054,00 €*
Martin T 60, T 65, T 70, T 75 PREX	Art.: 5051	1.434,00 €*
Robland Z 3200, NZ-Axis Ergo	Art.: 4397	1.420,00 €*
Robland PS-3200, PS-3200 X 1, PS 3200 X 3	Art.: 4388	1.468,00 €*
SCM class SI-400	Art.: 4387	1.345,00 €*

DOUBLE-SIDED MITRE FENCE DSG-D DIGITAL

Angle is adjusted **digitally**, length **analogically**. Includes adapter.

PANHANS 680_10_20	Art.: 5060	2.369,00 €*
PANHANS 690, V 91	Art.: 4390	2.398,00 €*
PANHANS 680_100_200	Art.: 5075	2.398,00 €*
Altendorf F 45, WA 8, WA 80	Art.: 4395	2.089,00 €*
Holzher Superslide 1245, 1290	Art.: 5054	2.063,00 €*
Holzskraft formal S	Art.: 5056	2.126,00 €*
Holzskraft SI 400 elite S	Art.: 5058	2.048,00 €*
Martin T 60, T 65, T 70, T 75 PREX	Art.: 5052	2.359,00 €*
Robland Z 3200, NZ-Axis Ergo	Art.: 5050	2.079,00 €*
Robland PS-3200, PS-3200 X 1, PS 3200 X 3	Art.: 4392	2.398,00 €*
SCM class SI-400	Art.: 4393	2.040,00 €*

If your type is not listed above, then an individual DSG can be created.

- You can choose between **analog** OR **digital**
- Clamping adapter must be ordered with

Double-sided mitre fence analog without Clamping adapter	Art.: 5080	879,00 €*
Double-sided mitre fence digital without Clamping adapter	Art.: 5081	1.859,00 €*
+ Clamping adapter customized according to customer specification to no. 5080 & 5081	Art.: 5082	879,00 €*

Suitable for all trolleys thanks to individual production.. Other models on request. *Price per unit.

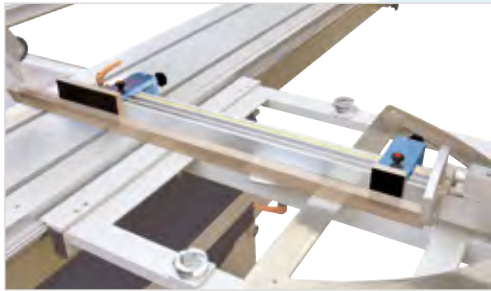

SAFETY-CUT

2-POINT SUPPORT FOR BREAK-OFF FREE SAWING

Clamping system for break-off free sawing with the crosscut fence. Individual auxiliary rods can be mounted with wood screws from the back or countersunk screws from the front.

A 2-point support permits easy cutting of bent wood as well.

The system consists of:

- 2 clamping units for aluminium profiles from a profile width of 40–100 mm and a profile height of 82 mm
- as well as 1 splinter tab and 1 counterwood

Safety-Cut
Art.: 3366

255,80 €
EACH



SAFETY-CUT PLUS

EXTENSION TO SAFETY-CUT

Fence extension by 300 mm, for mounting on Safety Cut (Art. : 3366, additionally required!) And for cuts up to 0 mm with 4 different mitre contact surfaces (-45° / + 45°, for use on both sides). For the safe cutting of short workpieces on the stop profile.

Scope of delivery::

- Fence extension
- Mounting elements
- Screws



Watch user video:
<https://www.youtube.com/watch?v=zp-829mlA80>

Safety-Cut plus
Art.: 3367

132,00 €
EACH



SAFETY-POWER

RECOMMENDED IN CONNECTION WITH SAFETY-CUT PLUS

Safety-Power for secure fastening of short and narrow workpieces to the fence, in the whole range of +45° up to -45°. Exact guidance along the groove on the sliding table and guide elements adjustable from 19 to 23 mm groove width.



Watch user video:
<https://www.youtube.com/watch?v=J04R1y0R90k>

Safety-Cut plus
Art.: 3368

144,80 €
EACH



MULTI-CUT

FRONT AND REAR SAW AID

For safe cutting, trimming, sawing after tearing as well as upright grooving in solid wood and board material. Solid wood can be held securely with the 3 clamping tips each. Due to the opposite rubber edges, workpieces up to approx. 10 mm width can be fixed securely and without damage. Easy clamping in the T-slot of the sliding table thanks to adjustable guide elements with a groove width of 19 – 23 mm.

Other widths on request.



Watch user video
<https://www.youtube.com/watch?v=E70vWw6x7gk>

Multi-Cut
Art.: 3364

252,50 €
EACH

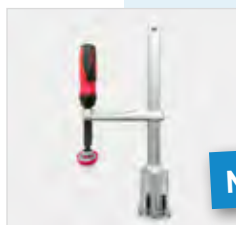

NEW

CLAMP FOR SLIDING TABLE

Clamp for sliding table
Art.: 3362

201,00 €
EACH

CIRCULAR SAWS

RIVING KNIFES FOR CIRCULAR SAW BLADES

FORCED-GUIDED RIVING KNIVES

ACCORDING TO DIN 38820=D AND MODEL 1772=T

Also suitable for concealed cuts, for the safe cutting of panels and solid wood.

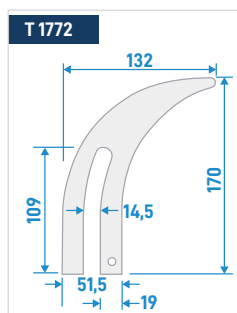
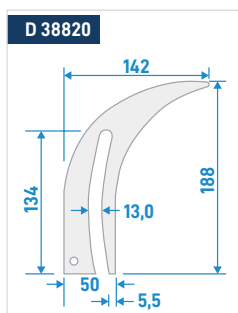

FOR SAWS FROM Ø 100–250 MM

DIN/MODEL	GROOVE WIDTH	THICKNESS	WEIGHT	Art.	Price
D 38820	13,0 mm	2,0 mm	100 g	3391	41,80 €
D 38820	13,0 mm	2,5 mm	150 g	3392	24,40 €
T 1772	14,5 mm	1,5 mm	50 g	3349	30,40 €
T 1772	14,5 mm	2,0 mm	80 g	3350	29,70 €
T 1772	14,5 mm	2,5 mm	100 g	3351	31,70 €
T 1772	14,5 mm	3,0 mm	100 g	3360	32,20 €

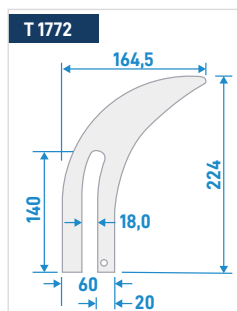
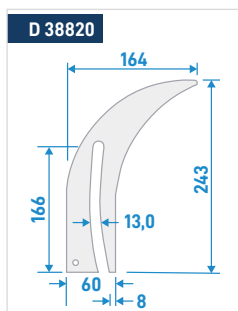

FOR SAWS FROM Ø 250–350 MM

DIN/MODEL	GROOVE WIDTH	THICKNESS	WEIGHT	Art.	Price
D 38820	13,0 mm	1,9 mm	150 g	3397	36,30 €
D 38820	13,0 mm	2,2 mm	200 g	3393	22,80 €
D 38820	13,0 mm	2,8 mm	300 g	3394	31,80 €
T 1772	18,0 mm	1,5 mm	350 g	3332	32,30 €
T 1772	18,0 mm	2,0 mm	150 g	3352	34,10 €
T 1772	18,0 mm	2,5 mm	200 g	3353	28,80 €
T 1772	18,0 mm	3,0 mm	250 g	3354	42,20 €

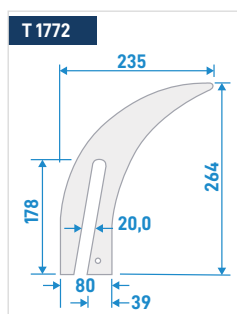
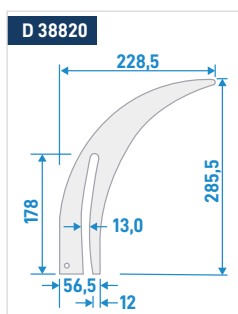

FOR SAWS FROM Ø 350–450 MM

DIN/MODEL	GROOVE WIDTH	THICKNESS	WEIGHT	Art.	Price
D 38820	13,0 mm	2,5 mm	250 g	3395	35,40 €
D 38820	13,0 mm	3,2 mm	300 g	3396	32,80 €
T 1772	20,0 mm	2,0 mm	150 g	3333	39,40 €
T 1772	20,0 mm	2,5 mm	250 g	3355	42,50 €
T 1772	20,0 mm	3,0 mm	300 g	3356	48,90 €
T 1772	20,0 mm	3,5 mm	350 g	3357	56,00 €
T 1772	20,0 mm	4,0 mm	350 g	3323	54,60 €

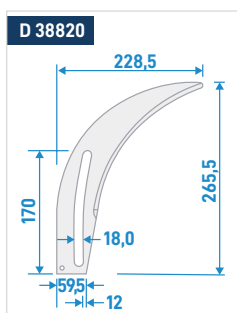

FOR SAWS FROM Ø 500–600 MM

DIN/MODEL	GROOVE WIDTH	THICKNESS	WEIGHT	Art.	Price
D 38820	18,0 mm	3,5 mm	700 g	3341	60,60 €

PANHANS RIVING KNIVES

ACCORDING TO MODEL 1792

With possibility to attach a protection hood with extraction.
Model 1794/1798

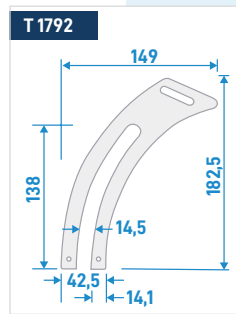

FOR SAWS FROM Ø 100–250 MM

DIN/MODEL	GROOVE WIDTH	THICKNESS	WEIGHT	Art.:	Price
T 1792	14,5 mm	1,2 mm	250 g	3334	22,70 €
T 1792	14,5 mm	1,5 mm	300 g	3335	31,50 €

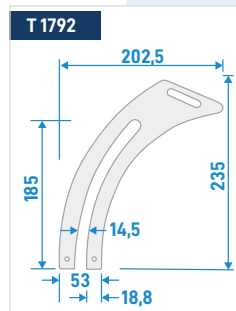

FOR SAWS FROM Ø 200–300 MM

DIN/MODEL	GROOVE WIDTH	THICKNESS	WEIGHT	Art.:	Price
T 1792	14,5 mm	1,5 mm	250 g	3336	42,40 €
T 1792	14,5 mm	2,0 mm	300 g	3337	31,90 €
T 1792	14,5 mm	2,5 mm	150 g	3234	31,70 €
T 1792	14,5 mm	3,0 mm	250 g	3239	40,20 €

PANHANS RIVING KNIFE

ACCORDING TO MODEL 1797

With possibility to attach a protection hood with extraction.
Model 1794/1798

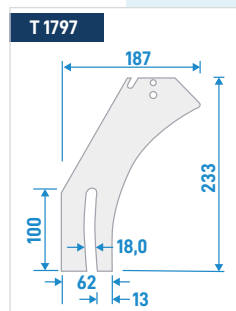

FOR SAWS WITH Ø 300–315 MM

DIN/MODEL	GROOVE WIDTH	THICKNESS	WEIGHT	Art.:	Price
T 1797	18,0 mm	2,5 mm	300 g	3370	44,30 €



Different forced-guided riving knives for saws from \varnothing 100–450 mm

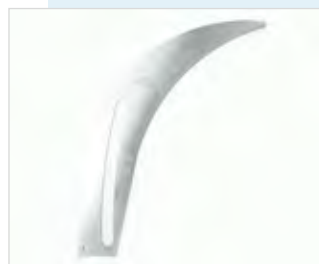

Different forced-guided riving knife D 38820 for saws from \varnothing 500–600 mm



PANHANS riving knives Model T 1792



PANHANS riving knives Model T 1797

GENERAL

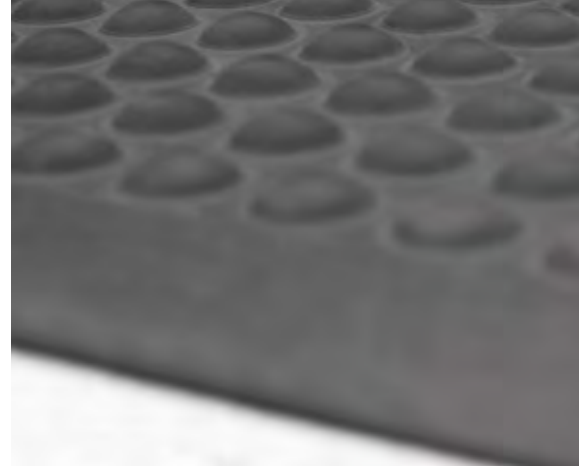

TRADITIONAL CRAFT MEETS MODERN SAFETY TECHNOLOGY

Different work processes, different machines and versatile personnel – future-oriented work provides safety when working on machines, health at work and safety for the personnel. The profitability of a company depends on healthy employees who can work effectively, safely and optimally. Various accessories from SI-TEC optimize work processes and workplaces in the long term.

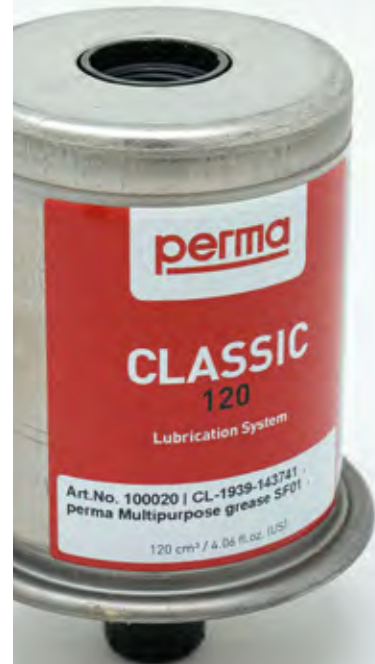



ABOUT US P.01

MILLING P.03

PLANNING P.13

BAND SAWS P.27

CIRCULAR SAWS P.29

GENERAL P.49

LIFT TABLES P.55

ACCESSOIRES P.63

APPENDIX P.73

GENERAL

ELECTRONIC KEY SYSTEM FOR MACHINE ACTIVATION: TM-100	50
ELECTRONIC KEY SYSTEM FOR MACHINE ACTIVATION: TM-300	51
ACCESSORIES FOR ELECTRONIC KEY SYSTEM FOR MACHINE ACTIVATION	52
ERGONOMIC WORK MATS	52
LEVELLER	52
DRILL CHUCK FOR HORIZONTAL SLOT MORTISING MACHINE	53
PNEUMATIC CLAMPING DEVICE	53
ACCESSORY SET FOR PNEUMATIC CLAMPING DEVICE	53
PERMANENT LUBRICATION CARTRIDGE	53

GENERAL



ELECTRONIC KEY SYSTEM FOR MACHINE ACTIVATION

The electronic key system is a simple and cost-effective solution for a reliable and safe machine access control which was previously realized via key switch. 3 variants offer a suitable system for every application. 5 tags (RFID keys) are supplied with each TM series device (1 red and 4 blue).

TECHNICAL DATA FOR TM-100 TO TM-300

Mounting	On the switch panel or in an aluminium housing
Dimensions	72 x 48 x 82,5 mm (WB x H x D)
Panel cut-out	67 x 46 mm (W x H)
Mounting depth	75,5 mm (without connector plug)
Dimensions of the mounting housing	107 x 56 x 110 mm (W x H x D)



TM-100 5 AUTHORIZATION LEVELS

The electronic key system TM-100 offers 5 tags: 1 administrator and 4 user levels for different authorized employees, which can already cover a large number of typical machine releases.

Depending on the user level of the respective key (marked with a number from 1 to 5*) up to 5 levels are possible.

- TM-100 tags pre-configured at choice with authorization level 1–5
- 1 digital output (PNP, active high) for administrator access (e.g. as key switch alternative)
- 4 digital outputs (PNP, active high) for further machine functions**

TECHNICAL DATA

Power supply	10 ... 30 VDC
Interface	RS232 (for parametrization)
Data memory	Internal Flash
Connections	pluggable 12-pin screw terminal
Outputs	5 digital outputs (PNP, active high) Each key number 1–5
Protection class	Front side: IP65 Rear side IP30

* Authorization level 5 = Full access (Administrator)

** available as an option

TM-100
Art.: 4667

812,00 €
EACH



Watch user video:
<https://www.youtube.com/watch?v=L4izrlvbEw>



TM-300 UNLIMITED NUMBER OF TAGS

The TM-300 electronic key system offers high-end functions for reliable and secure machine access control. All data are fully network-compatible via Modbus / TCP and can therefore be further processed without any problems. Our clearly structured user software also allows direct communication with connected machine controls, including visualization of the relevant machine parameters.

- Unlimited number of tags (TM-100 tags can also be taught in)
- Database and network connection via Modbus/TCP
- 1 digital output (PNP, active high) for administrator access (e.g. as key switch alternative)
- 4 digital outputs (PNP, active high) for further machine functions*
- Modbus/TCP for parametrization and connection to the network
- Additional serial RS232 interface for error analysis
- Built-in panel housing (optionally built-in housing for surface mounting)

TECHNICAL DATA

Power supply	10 ... 28 VDC
Interface	Modbus/TCP according to CP15/1 Norm
Data memory	Network database
Connections	Power supply: pluggable 3-pin screw terminal Network connection: RJ45 socket (rear)
Outputs	1 digital output Master (PNP, active high) for user levels
Protection class	Front side: IP65 Rear side IP30

* available as an option

TM-300 Art.: 4669	1.610,00 € EACH
-----------------------------	---------------------------

ACCESSORIES FOR MACHINE ACTIVATION | AT PAGE 52



THE NEW ONLINESHOP FOR WOOD CRAFTSMEN!

24 hours a day, 7 days a week, 365 days a year:

Now you can order equipment, machines, spare parts, consumables, accessories and much more online from the comfort of your home or workshop – without the hassle of opening hours:

 www.hokubema.com



ACCESSORIES

ELECTRONIC KEY SYSTEM FOR MACHINE ACTIVATION

The electronic key system is a simple and inexpensive solution for reliable and secure machine access control, which was previously implemented with a key switch or password.

Extra tags User Blue (Pckg.: 10 pcs.) Art.: 4670	139,00 € 10 PCS. SET
Extra tags Master Red (Pckg.: 1 pc.) Art.: 4671	28,00 € EACH
Reader (for TM-300) Art.: 4672	898,00 € EACH

ELECTRONIC KEYSYSTEM FOR MACHINE ACTIVATION | AT PAGE 50

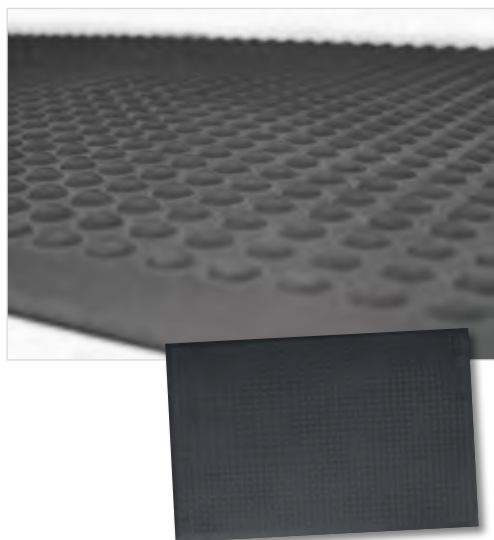

ERGONOMIC WORK MATS

Made of PUR integral foam with round pastille surface.

The perfect equipment for standing workstations.

- Scientifically proven ergonomic effectiveness:
Reduction of body and articulations load by 60% (according to a study by the Ergonomie Institut München)
- Preventive against cramps and circulation problems
- Reduces fatigue in feet, legs, back through dynamic stimulation of the muscles
- Preventive against degenerative joint changes on feet, knees, spine, hips
- Reduced risk of tripping due to run-on slope

These benefits can help to reduce employee downtime and thus preserve the company's most important resource - your employees health.

ca. 2,9kg

950x650x13cm
(LxWxH)

RAL 7016
anthracite

Ergonomic work mats

Art.: 4690

50,80 €

EACH



LEVELLER

This stainless-steel foot is the suitable adjustment element for many requirements. A damper insert made of nitrile rubber (NBR) makes it difficult to transmit vibrations to floors and buildings.

Consisting of:

- Threaded spindle M12x100 mm usable thread length
- Connected to a plate with a diameter of 100 mm and a NBR damper

Optionally available with side fixing strap.

up to 1.200,0kg

Leveller

Art.: 4813

39,50 €

EACH



DRILL CHUCK FOR PANHANS HORIZONTAL SLOT MORTISING MACHINE

Three-jaw clamping chuck with clamping range of 5–20 mm and a shortened taper mount B24. Impact resistant key-type drill chuck with key, tapered or threaded mount according to DIN ISO 10887 (toothing according to DIN 6349). Drilled-through version for clockwise and counterclockwise rotation with high precision.

Benefits

- High rotation accuracy of up to 0,15 mm
- Increased clamping force thanks to a proven transmission principle through a drill chuck key

Drill chuck for PANHANS horizontal slot mortising machine

Art.: 4814

379,00 €
EACH

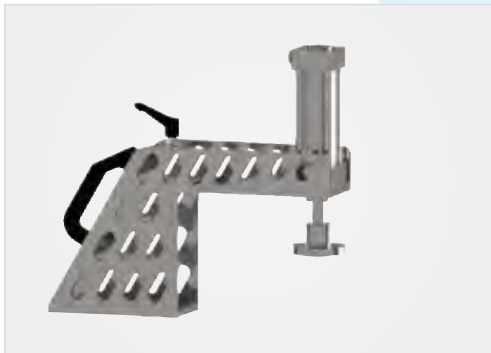

PNEUMATIC CLAMPING DEVICE

The pneumatic safety cylinder fixes workpieces on the sliding table with a clamping force of 500N–1000N. It can be used on all milling machines, circular saws and other machines on which workpieces must be firmly fixed. Clamping takes place comfortably, flexibly and safely.

- Stroke: 100 mm
- Air connection: 3–6 bar

SCOPE OF DELIVERY: Clamping device with hand slide valve, pressure regulator.

Pneumatic clamping device

Art.: 3363

795,00 €
EACH

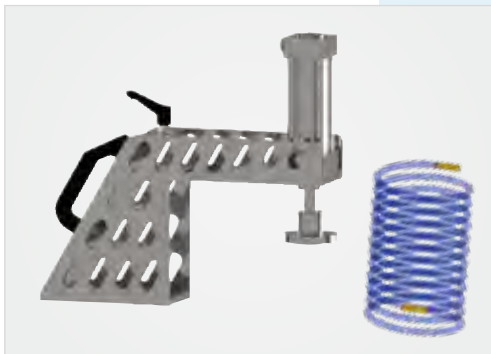

ACCESSORY SET FOR PNEUMATIC CLAMPING DEVICE

Required when two pneumatic clamping devices are operated at the same time.

SCOPE OF DELIVERY: clamping device, spiral hose.

Pneumatic clamping device accessory set

Art.: 3812

645,00 €
EACH



PERMANENT LUBRICATION CARTRIDGE

Enables effective, long-term cost-efficient and low-maintenance long-term lubrication. Provides the lubrication point continuously and automatically with fresh lubricant. Reduces the need through an optimal supply of lubricant.

 **Dispensing time: ca. 12 months**

Permanent lubrication cartridge

Art.: 0345.0606

58,30 €
EACH

LIFT TABLES



THE BASIC CONCEPT: PREVENTION

With height-adjustable worktables, different body sizes as well as the dimensioning and positioning of the workpieces can be taken into account. Ergonomically optimized workplaces where employees work without risks also contribute to a better working atmosphere and promote productivity by counteracting sickness-related absences.





ABOUT US P.01

MILLING P.03

PLANING P.13

BAND SAWS P.27

CIRCULAR SAWS P.39

GENERAL P.49

LIFT TABLES P.55

ACCESSOIRES P.63

APPENDIX P.73

LIFT TABLES

ROLLER BLOCK STAND	56
CRAFTSMAN'S BOY	56
HEIGHT-ADJUSTABLE WORKING TABLE HS 300	56
HEIGHT-ADJUSTABLE WORKING TABLE HS 300-PLUS WITHOUT/WITH BEECH MULTIPLEX PERFORATED GRID PLATES	57
HEIGHT-ADJUSTABLE WORKING TABLE HS 300-MIDI WITH SWING FRAME	57
ACCESSORIES FOR PERFORATED TOPS:	58
SCREW CLAMPS, TENSION CLAMPS, ROUND STOP PINS, ANGLE-GEAR QUICK CLAMPS, COUNTER BEARINGS, ANTI-SLIP RAILS	
WORKING AND ASSEMBLY TABLE ERGOPLAN EP1, EP2, EP3	60
ERGOPLAN BENCH HOOK	61
TRANSPORT AND RELAY CART KUNO	61
PAINTING AND PICKING CART TRAPEZ	61
PAINTING AND PICKING CART MULTI-CAR MIDI	61

LIFT TABLES



Roller block stand with plastic roller



Roller block stand with multi-directional roller bar



ROLLER BLOCK STAND

The practical working aid on all processing machines. Height adjustment is infinitely variable by means of a central handwheel.

 **Load capacity: 500,0kg each**

With plastic roller

Length: 700 mm
Height: min. 760 – max. 1.030 mm
Roller: ø 90 mm
Art.: **92 100 01**

649,00 €
EACH

With multi-directional roller bar

Length: 980 mm
Height: min. 700 – max. 960 mm
Art.: **92 100 02**

758,00 €
EACH

CRAFTSMAN'S BOY

5-FOOT ROLLER BLOCK, WITH PLASTIC ROLLER

Serves as a light roller stand variant on processing machines. The steplessly adjustable construction is available with a horizontal roller or pipe fork.

TECHNICAL DATA

Length	400 mm
Height	steplessly adjustable: 650 – 1050 mm
Roller	ø 50 mm

 **ca. 7,0 kg**  **Load capacity: 120,0 kg**

Craftsman's boy

Art.: **93 0002**

249,00 €
EACH

HEIGHT-ADJUSTABLE WORKING TABLE HS 300

Stable working table that can be quickly and easily adjusted in height via a central foot pedal.

Usable as stacking cart, machine loading/unloading cart, ...

TECHNICAL DATA

Stroke	610 mm
Min. height	400 mm
Max. height	1010 mm
Top dimension	1000 x 600 mm
4 castors, 2 of which with brake	

 **ca. 75,0 kg**  **Load capacity: 300,0 kg**

HS 300

Art.: **190.100**

1.275,00 €
EACH



HEIGHT-ADJUSTABLE WORKING TABLE HS 300 PLUS

WITHOUT OR WITH BEECH MULTIPLEX PERFORATED WORKTOP (HOLES: Ø 22 MM)

It can work with several functional elements. The height is adjusted through a manual foot pump. The worktop size is particularly suitable for large workpieces.



Watch user video:
<https://www.youtube.com/watch?v=wfAbhbQEj00>

TECHNICAL DATA

Stroke	610 mm
Min. height	without top: 400 mm with top: 430 mm
Max. height	without top: 1010 mm with top: 1040 mm
Top size	1900 x 740 mm
Top plate size	2000 x 1000 mm
4 castors, 2 of which with parking brakes	

ca. 198,0 kg

Load capacity: 300,0 kg

HS 300-Plus without top

Art.: 191.100

2.115,00 €

EACH

HS 300-Plus with beech multiplex perforated worktop (holes: Ø 22 mm)

Art.: 191.102

2.498,00 €

EACH



HEIGHT-ADJUSTABLE WORKING TABLE HS 300 MIDI

WITH SWING FRAME

For a quick and easy panel handling.

The swing frame mounted instead of the worktop allows an easy displacement of large panels from the horizontal to the vertical position on processing machines.



Watch user video:
<https://www.youtube.com/watch?v=r2owyNixNEw>

The swing frame can be easily operated by one person.

TECHNICAL DATA

Stroke	610 mm
Min. height	400 mm
Max. height	1010 mm
Lifting tabletop	1200 x 740 mm
External frame dimensions	1800 x 1480 mm
4 castors, 2 of which with brake	

ca. 160,0 kg

Load capacity: 300,0 kg

HS 300-midi with swing frame

Art.: 190.220

3.249,00 €

EACH



Also suitable for
metal tops

LIFT TABLES

ACCESSOIRES FOR PERFORATED GRID PLATES



ACCESSORIES FOR PERFORATED TOPS WITH A HOLE DIAMETER OF 22 MM

A worktable with a perforated grid plate can be used in many ways and offers solutions for optimized work processes with a wide range of accessories. Clamping, gluing, pressing, grinding, polishing and all other work processes can be carried out easily and with little effort on your lifting table thanks to the practical clamps and clamps in combination with stop pins or individual abutments. To do this, select your practical accessories to match your new lift table with perforated grid plate.



VERTICAL CLAMP 30X7MM TO FIX THE WORKPIECE FROM ABOVE

With locking bolt

- Adjustable up to 200mm workpiece thickness
- 360° swivelling

Vertical clamp
Art.: 200.603

72,40 €
EACH



HORIZONTAL CLAMP TO FIX THE WORKPIECE FROM THE SIDE

Clamping spigot with threaded spindle and pressing plate.

Horizontal clamp
Art.: 200.607

42,80 €
EACH

RECOMMENDED ACCESSORY:

CLAMP FOR SLIDING TABLE | AT PAGE 45



STOP PIN, ROUND AS A COUNTERPIECE FOR FASTENING WORKPIECES

The stop can also be used as a direct counter piece of the workpiece.

- Pin: \varnothing 40/22 mm
- 40 mm long
- In POM plastics, black

Stop pin, round
Art.: 200.602

19,40 €
EACH



ANGLE-GEAR QUICK CLAMP PROVIDES FOR A UNIFORMLY STRONG CLAMPING

The quick clamp can be firmly positioned on the perforated grid plate and allows a uniformly strong clamping up to 500 kg.

- Stroke: 130 mm
- Pressing plate: 100 mm x 78 mm
- With 2 locking bolts

Angle-gear quick clamp
Art.: 200.608

289,50 €
EACH



COUNTER BEARING COUNTERPIECE TO THE QUICK CLAMP

The counter bearing is the counter piece of the quick clamp for clamping and fixing the workpieces.

- With locking bolts and safety plug

Counter bearing
Art.: 200.601

64,50 €
EACH

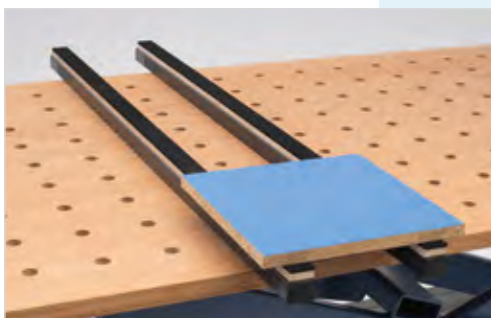

ANTI-SLIP RAILS, 2 PCS. SET FOR A SLIP-PROOF PROCESSING OF OBJECTS WITHOUT CLAMPING

2 anti-slip rails with a length of 600 mm or 1200 mm and 2 locking bolts, suitable for all perforated grid plates with a hole diameter of 22 mm.

Suitable for all BECK lift tables. The present set does not include any lift table.

Anti-slip rails 600 mm
Art.: 200.612-2

219,00 €
2 PCS SET

Anti-slip rails 1200 mm
Art.: 200.610-2

228,00 €
2 PCS SET

LIFT TABLES

WORKING AND ASSEMBLY TABLE ERGOPLAN



Watch user video:
<https://www.youtube.com/watch?v=3KillNvSc6w&t=3390s>

The classic joiner's bench combined with the height-adjustable worktable form an ergonomically optimized workplace and open up new possibilities in woodworking.

The joiner's bench table with 120 mm thickness has front and rear vices as well as holes on the table surface and on the front.

TECHNICAL DATA

Load capacity	500,0 kg
Stroke	300 mm
Mix. height	780 mm
Max. height	1080 mm
Joiner's bench top (except-EP3)	1700 x 640 x 120 mm



WORKING AND ASSEMBLY TABLE ERGOPLAN EP 1 STATIONARY WITH TROLLEY AND MOUNTED JOINER'S BENCH TOP

- Steplessly height adjustable
- Lifting and lowering via foot-operated hydraulic lifting unit
- Stationary version with 4 foot plates
- Adjustable +/-15 mm for ground levelling
- Trolley with 4 castors (castor: ø 80 mm) including lever mechanism with central operating lever

ACCESSORIES INCLUDED: Joiner's bench plate 1700 x 640 x 120 mm with 1 rear and one front vice; holes on the front side and above; rear cover as scissors protection; steel sheet shelf

ErgoPlan EP 1
Art.: 211.100

4.476,00 €
EACH



WORKING AND ASSEMBLY TABLE ERGOPLAN EP 2 STATIONARY WITH MOUNTED JOINER'S BENCH TOP (WITHOUT TROLLEY)

- Steplessly height adjustable
- Lifting and lowering via foot-operated hydraulic lifting unit
- Stationary version with 4 foot plates
- Adjustable +/-15 mm for ground levelling

ACCESSORIES INCLUDED: Joiner's bench plate 1700 x 640 x 120 mm with 1 rear and one front vice; holes on the front side and above; rear cover as scissors protection; steel sheet shelf

ErgoPlan EP 2
Art.: 211.110

3.829,00 €
EACH



WORKING AND ASSEMBLY TABLE ERGOPLAN EP 3 STATIONARY (WITHOUT TROLLEY AND JOINER'S BENCH TOP)

- Steplessly height adjustable
- Lifting and lowering via foot-operated hydraulic lifting unit
- Stationary version with 4 foot plates
- Adjustable +/-15 mm for ground levelling

ACCESSORIES INCLUDED: Steel sheet shelf

ErgoPlan EP 3
Art.: 211.120

2.345,00 €
EACH

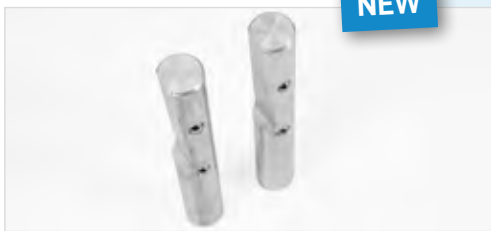

NEW

ERGOPLAN BENCH HOOK

- 2 pieces
- Diameter 30 mm, 200 mm long

ErgoPlan bench hook 2 pieces Ø30 mm, 200 mm long
Art.: 210.640

74,00 €
2 PCS SET



TRANSPORT AND RELAY CART KUNO WITH FOLDABLE WORKTOP

Our transport and relay cart KUNO is ideal for production, maintenance, storage and shipping. What is special about the KUNO is that the worktop can be folded into the base frame if necessary, so that several transport trolleys can be placed next to each other to save space.

TECHNICAL DATA

Min. height	800 mm
Max. height	1040 mm
Panel size	1000 x 720 mm
External dimensions	1100 x 800 mm
Wheel	ø 100 mm
4 castors, 2 of which with parking brake	
Painting	Powder-coating RAL 7035 light grey

ca. 46,0 kg

Load capacity: 300,0 kg

KUNO
Art.: KU 010

458,00 €
EACH



Watch user video:
<https://www.youtube.com/watch?v=BWikogSC-AQ>



PAINTING AND PICKING CART TRAPEZ FOR SPACE-SAVING STORAGE UNTIL NEXT PROCESSING

Suitable storage place for painted panels, wood strips or profiles with sensitive surfaces. Almost everything can be stored safely, clearly and in a space-saving manner until it can be further processed.

TECHNICAL DATA

Rack width	min. 500 mm max. 2000 mm
Rack depth	510 mm
Number of racks	15 levels with rubber coating, Distance: approx. 78 mm
Dimensions (L x W x H)	910 x 700 x 1850 mm

ca. 90,0 kg

Load capacity/Rake: 40,0 kg
(max. 600,0 kg distributed)

TRAPEZ
Art.: TR 010

956,00 €
EACH



PAINTING AND PICKING CART MULTI-CAR MIDI FOR SPACE-SAVING STORAGE UNTIL THE NEXT PROCESSING

With the MULTI-CAR MIDI you are always right when it comes to providing panels, furniture fronts and other parts.

TECHNICAL DATA

Groove width	23 mm
Racks	2 x 13 grooves below 2 x 13 grooves, height adjustable
Dimensions (L x W x H)	1450 x 650 x 1900 mm

ca. 100,0 kg

Load capacity: 500,0 kg

MULTI-CAR MIDI
Art.: MC 015

1.535,00 €
EACH

ACCESSOIRES



OPTIMIZED WORK INCLUDES MORE THAN SAFETY TECHNOLOGY

Modern and optimized work stands for good organization, user-friendly concepts and easy handling of work processes. A well-conceived maintenance plan, effective writing material or versatile pliers are often sufficient. In our accessories section you will find many useful everyday helpers for workshop needs and beyond.

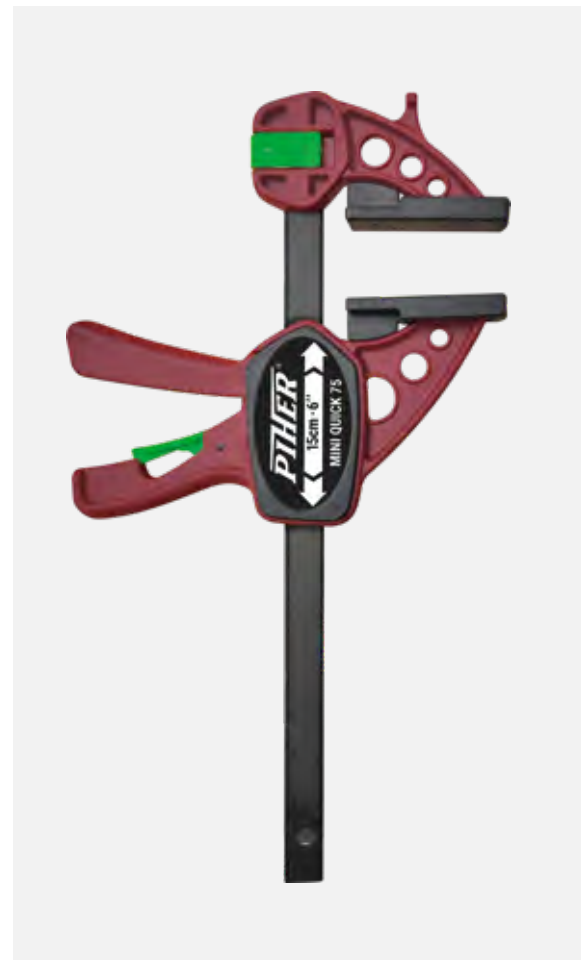



ABOUT US P.01

MILLING P.03

PLANNING P.13

BAND SAWS P.27

CIRCULAR SAWS P.39

GENERAL P.49

LIFT TABLES P.55

ACCESSOIRES P.63

APPENDIX P.73

ACCESSORIES

PENCILS PANHANS	64
PENCILS WOODPECKER	64
HAND BRUSH PANHANS	64
HAND BRUSH WOODPECKER	64
MAINTENANCE PLAN BOOKLETS HOIKUIBEIMA	64
POLO SHIRTS WOODPECKER	65
TAJIMA PIT SAW JAPAN PULL 265 R	65
TAJIMA CUTTER KNIFE WITH SAFETY HOLSTER	65
DIFFERENT PIHER SCREW CLAMPS	66
BOW TOOLS	68
GUHDO TOOLS	70

ACCESSOIRES



PENCILS PANHANS SET OF 10 PCS.

Set of 10 pieces of wooden pencils in PANHANS Design. Classic round pencil with a barrel made of colourless painted wood with a matt surface.

- Round, ø 7 mm, Length: 175 mm
- With transparent protective coating to prevent dirt
- Hardness grade HB
- Made in EU in PEFC-approved wood

Pencils PANHANS

Art.: BleistifteP

3,50 €

10 PCS SET



PENCILS WOODPECKER SET OF 10 PCS.

Set of 10 pieces of wooden pencils in WOODPECKER Design. Classic round pencil with a barrel made of colourless painted wood with a matt surface.

- Round, ø 7 mm, Length: 175 mm
- With transparent protective coating to prevent dirt
- Hardness grade HB
- Made in EU in PEFC-approved wood

Pencils WOODPECKER

Art.: BleistifteW

3,50 €

10ER-SET



HAND BRUSH PANHANS

Hand brush in wood in PANHANS design with wood body and hanging hole.

Hand brush PANHANS

Ar.: BesenP

3,50 €

EACH



HAND BRUSH WOODPECKER

Hand brush in wood in WOODPECKER design with wood body and hanging hole.

Hand brush WOODPECKER

Art.: BesenW

3,50 €

EACH



MAINTENANCE PLAN BOOKLET HO|KU|BE|MA

Regular maintenance is advisable to increase the longevity of machines. A pre-printed maintenance plan booklet is helpful and useful to document the maintenance and thus the service of the machine correctly. The table shows the most precise information and activities that should be observed during the test.

Maintenance notebook for machines

Art.: WBHOK

8,90 €

EACH

Maintenance notebook planing machines

Art.: WBHOKHOBEL

8,90 €

EACH

SAMPLE:
SEE P.79
AND P.80



POLO SHIRT WOODPECKER

- Polo shirt printed on both sides in the WOODPECKER design (Front side: mascot Paul, sleeve: Logo, rear side: Slogan)
- Colour: Beige
- Available sizes: M, L
- 100% cotton
- Three button stripe with buttons of the same colour
- Side slits

Polo-Shirt WOODPECKER

Art.: ShirtsW

24,50 €

EACH



TAJIMA PIT SAW JAPAN PULL 265 R

- Precision pit saw with quick change system
- Cross saw can cut anything - thick or thin
- Fluorine coating prevents resin from seizing and sticking
- Blade length 265mm

TAJIMA pit saw Japan Pull 265 R

Art.: T18.12.0161

29,90 €

EACH



TAJIMA CUTTER KNIFE WITH SAFETY HOLSTER

- Cutter knife with automatic retraction of the blade
- 18mm RAZAR BLACK BLADE

TAJIMA Cutter knife with safety holster

Art.: T18.12.0158

18,50 €

EACH



THE NEW ONLINESHOP FOR WOOD CRAFTSMEN!

24 hours a day, 7 days a week, 365 days a year:

Now you can order equipment, machines, spare parts, consumables, accessories and much more online from the comfort of your home or workshop – without the hassle of opening hours:

 www.hokubema.com

ACCESSOIRES

SCREW CLAMPS

A ingenious system based on spindle technology ensures optimum hold in all applications. Whether screw clamp or load bar - all products from the Spanish manufacturer are quick and easy to assemble and also withstand particularly high loads. Locksmiths, carpenters, stair builders and carpenters need the right tools every day to put materials under the desired tension and to connect, separate or hold them together. Piher offers professional solutions for this area and builds on the power of the spindle. A special feature of the products are technical properties that are often only recognizable at a second glance, for example their exceptional speed and precision.

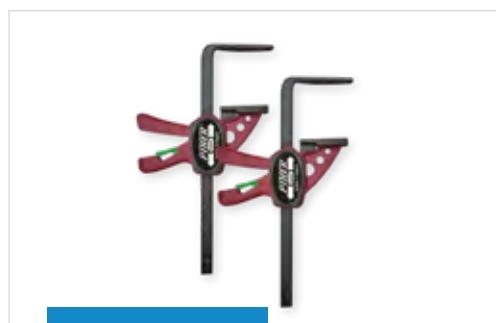

SET WITH 2 PIECES

PIHER®

SET 1: T-TRACK ONE-HAND CLAMPS PIHER 15 CM

2x T-Track Quick PIHER 15 cm

- Flat head for guide rail 12x8 mm
- Clamping force up to 60 kg
- Fixed and sliding arm consisting in a combination of nylon and fiberglass
- Plastic protection caps included
- Made of rolled steel
- Easy to use with one hand
- In plastics. No oils. Leaves no marks.

Set 1: T-Track Quick PIHER 15 cm

Art.: PI-Set1

34,30 €

SET PRICE

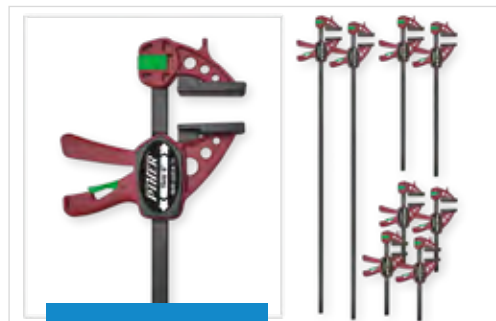

SET WITH 8 PIECES

PIHER®

SET 2: ONE-HAND CLAMPS QUICK PIHER

4x One-hand clamp Quick PIHER 15 Extra

2x One-hand clamp Quick PIHER 30 Extra

2x One-hand clamp Quick PIHER 60 Extra

- Clamping force up to 150 kg
- Fixed and sliding arm consisting in a combination of nylon and fiberglass
- Rail in hardened carbon steel
- The head can be turned to spread instead of pressing
- Easy to use with one hand
- In plastics. No oils. Leaves no marks.

Set 2: One-hand clamps Quick PIHER

Art.: PI-Set2

176,30 €

SET PRICE

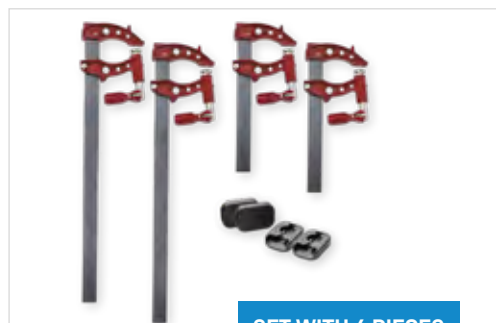

SET WITH 6 PIECES

PIHER®

SET 3: SCREW CLAMPS PIHER MAXI F

2x Screw clamps PIHER Maxi F-30 cm

2x Screw clamps PIHER Maxi F-60 cm

2x Protective caps for MAXI F & R (2 pieces)

- Clamping force: up to 9.000 N
- Rail: 35 mm x 8 mm
- Nosing: 12 cm
- Protected thread
- Ergonomic handle
- Lever action

Set 3: Screw clamps PIHER Maxi F

Art.: PI-Set3

134,70 €

SET PRICE

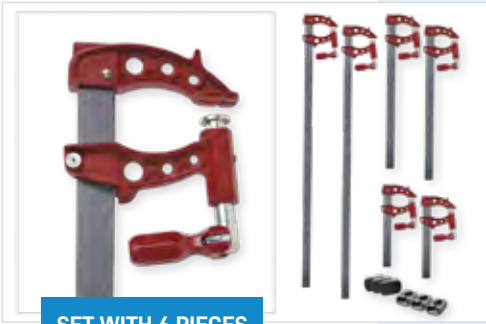

SET WITH 6 PIECES

PIHER®
SET 4: SCREW CLAMPS PIHER MAXI F

- 2x Screw clamp PIHER Maxi F-20 cm
- 2x Screw clamp PIHER Maxi F-40 cm
- 2x Screw clamp PIHER Maxi F-80 cm
- 3x Protective caps for MAXI F & R (2 pieces)

- Clamping force: up to 9.000 N
- Rail: 35mm x 8mm
- Nosing: 12 cm
- Protected thread, ergonomic handle, lever handle

Set 4: Screw clamps PIHER Maxi F
Art.: PI-Set4

205,90 €
SET PREIS

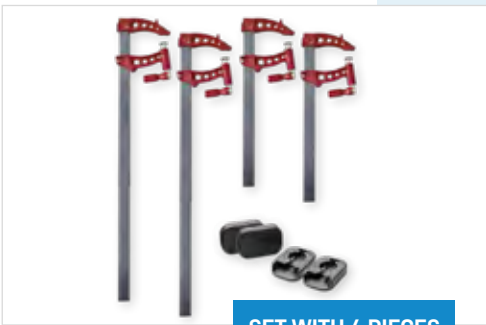

SET WITH 4 PIECES

PIHER®
SET 5: SCREW CLAMPS PIHER MAXI R

- 22x Screw clamp PIHER Maxi R-60 cm
- 2x Screw clamp PIHER Maxi R-100 cm
- 2x Protective caps for MAXI F & R (2 pieces)

- Clamping force: up to 10.000 N
- Rail: 40 mm x 10 mm
- Nosing: 16 cm
- Protected thread, ergonomic handle, lever action

Set 5: Screw clamps PIHER Maxi R
Art.: PI-Set5

254,20 €
SET PREIS

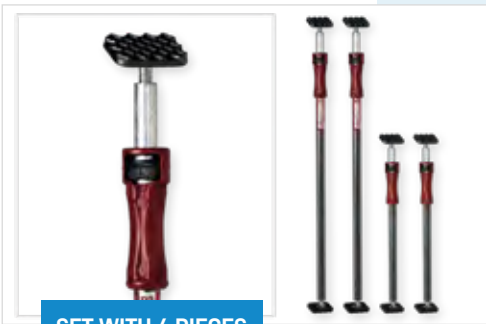

SET WITH 4 PIECES

PIHER®
SET 6: LOAD-BEARING RODS SET

- 2x Load-bearing rod@ 60 cm up to 100 cm / P1
- 2x Load-bearing rod@ 155 cm up to 290 cm / P3

- Up to 300 kg
- Easy to use
- Can be adjusted to different angles

Set 6: Load-bearing rods set
Art.: PI-Set6

147,00 €
SET PRICE

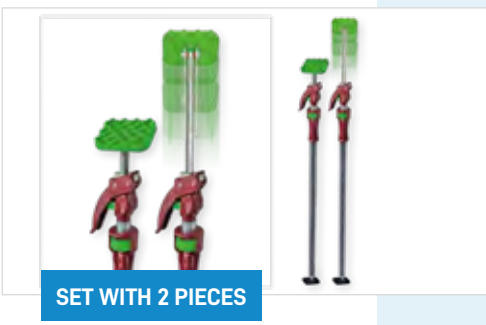

SET WITH 2 PIECES

PIHER®
SET 7: LOAD-BEARING RODS SET

- 2x Load-bearing rod@ 168 cm up to 300 cm / P3 ARM+

- Easy to use
- Can be adjusted to different angles

Set 7: Load-bearing rods set
Art.: PI-Set7

121,50 €
SET PRICE

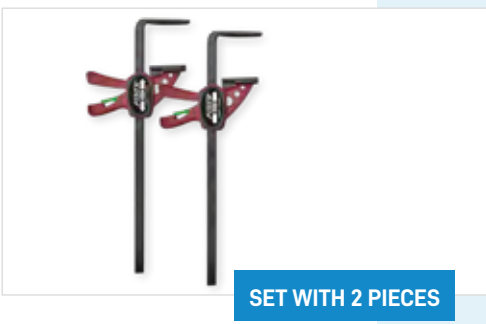

SET WITH 2 PIECES

PIHER®
T-TRACK QUICK PIHER 22 CM 2PCS-SET

- Flat head for guide rail 12x8 mm
- Clamping force up to 60 kg
- Fixed and sliding arm consisting in a combination of nylon and fiberglass
- Made of rolled steel, plastic protection caps included
- Easy to use with one hand
- Leaves no marks.

T-Track Quick PIHER 22 cm im 2er-Set
Art.: PI52103.2

37,50 €
SET PRICE

PRESSURE COMBS



BOW FP2 PRO

Better cutting quality, as workpiece vibrations are avoided. The hard foam joints absorb energy and reduce the risk of kickback. Easier material feed than with plastic or wood pressure combs, as there is less back pressure for the same effect.

- Simply turn compression springs for left or right rotation
- With softwood, the hard foam leaves no traces, even with high contact pressure
- Cuted feathers can be exchanged
- High density EVA rubber slider
- Exclusive design. Flexible and avoids unwanted recoil
- Body made of PA with fiberglass

BOW FP2 Pro

Art.: 63100

51,20 €
EACH



BOW FP3 DUO

Better cutting quality, as workpiece vibrations are avoided. The hard foam joints absorb energy and reduce the risk of kickback. Easier material feed than with plastic or wood pressure combs, as there is less back pressure for the same effect.

- Specially designed for high parts on circular table saws, band saws and milling machines
- Reaches a height of 10 cm
- Body made of PA with glass fiber
- Fits 3/4" slots
- Includes T-bolts for 1/4" slots
- Includes 2 additional Ultralight spare parts

BOW FP3 Duo

Art.: 63101

102,30 €
EACH



REPLACEMENT COMB FPS2

Replacement comb for FP1 Pro and FP3 Duo

- Wider connection at the feathers, making them more rigid and guaranteeing a clean cut even under stronger pressure

Replacement comb FPS2

Art.: 63102

25,10 €
EACH



REPLACEMENT COMB FPU2

Replacement comb for FP1 Pro and FP2 Duo.

- Thinner connection on the feathers, making them more flexible and guaranteeing a clean cut even on smaller workpieces.
- Ideally suited for fine work

Replacement comb FPU2

Art.: 63103

25,10 €
EACH



BOW GP5 PRO

- Silicone slider dampens vibration for a clean cut
- Applies constant pressure to the workpiece
- Body made of PA with glass fiber
- Comfortable and ergonomic handle
- Flexible, adapts to even irregular parts
- Assistance for band saws and milling machines

BOW GP5 Pro
Art.: 63104

132,20 €
EACH



BOW PP1 SLIDE

Sliding stick with replaceable EVA tip, which prevents vibrations. Protects the workpiece, the tool and most of all your hands

BOW PP1 slide
Art.: 63107

34,50 €
EACH



BOW PPR1 SPARE PART

Replacement tips for BOW PP1 slider

- Made of EVA, prevents vibrations
- 2 pieces in set

BOW PPR1 spare part
Art.: 63108

8,30 €
2 PCS SET



BOW GP9 ANCHOR

Extension for the BOW GP5, for a secure hold, even with machines like a sliding table saw

BOW GP9 anchor
Art.: 63106

42,80 €
EACH



BOW GP7 EXTENSION

An extension of the height for BOW GP5, suitable for guiding high workpieces

BOW GP7 extension
Art.: 63105

34,50 €
EACH

GUHDO - a quality brand for over 100 years. The company was founded in Remscheid, the center of the Bergisches Werkzeugindustrie, in 1908. In 1967 the company moved to Wermelskirchen as part of an expansion of production.

The company continues to set standards through its progressive, partly patented in-house developments. Quality and reliability make GUHDO very quickly a competent and sought-after partner for the specialist trade and of course also for the professional user.

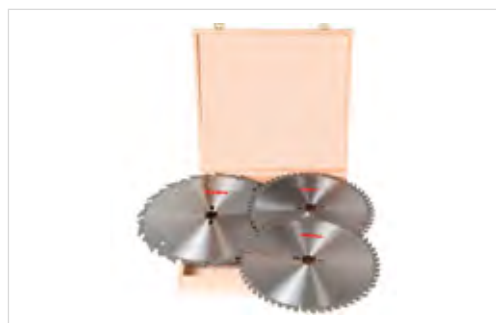

GUHDO® 3-PIECE SAW SET

Ø 303 x 3,2/2,2 x 30 mm Z 60 DH:

- For clean cuts on both sides of plastic-coated panels
- Can be used on table saws and vertical panel saws
- Dachhohlzahn

Ø 305 x 3,7/2,5 x 30 mm Z 32 WZ:

- For longitudinal / cross cuts in solid wood. For separating cuts in wood board materials, also veneered on one side or covered with plastic on one side

■ Alternate tooth with deflector

Ø 305 x 3,5/2,5 x 30 mm Z 54 WZ:

- For panel materials both veneered or plastic coated on one side
- Alternate tooth

Set price complete

Art.: 2000.850.91

162,30 €

EACH



PREMIUM 1:

GUHDO® HW SAW SET 2-PIECE IN WOODEN CASE

Allround saw blade PI-100 Piano plus version:

Ø 303 x 3,2/2,2 x 30 mm Z 46 WZ

Dachhohlzahn-Saw blade Classic:

Ø 303 x 3,2/2,2 x 30 mm Z 60 DH

Set price complete

Art.: 2000.850.86

102,70 €

EACH



PREMIUM 2:

GUHDO® HW-SAW SET 2 -PIECE IN WOODEN CASE

G-coat-version

Dachhohlzahn-Sägeblatt:

Ø 303 x 3,2/2,2 x 30 mm Z 60 DH

Crosscut saw blade:

Ø 303 x 3,2/2,2 x 30 mm Z 28 WZ

Set price complete

Art.: 2000.850.87

115,70 €

EACH



GUHDO®
HW-CIRCULAR SAW BLADE SET IN WOODEN CASE

The DUET Set consisting in:

- Main saw blade: ø 300 x 3,20 x 30 mm Z = 72 WZ
- Scoring saw blade: ø 125 x 3,35 x 22 mm Z = 24 FZ

Set price complete
 Art.: 2100.300.01

159,00 €
 EACH

The DUET Set consisting in:

- Main saw blade: ø 300 x 3,20 x 30 mm Z = 72 Trapezoid-Flat tooth
- Scoring saw blade: ø 125 x 3,35 x 22 mm Z = 24 FZ

Set price complete
 Art.: 2100.300.02

159,00 €
 EACH



GUHDO®
CUTTERHEAD WITH 12 PROFILES AND DEFLECTOR
UNIVERSAL-MK-SET 100 X 40/50X30 IN WOODEN CASE

The set consisting in:

- 1 MK= 03.100.050.430.A
- 100x40/50x30
- 12 pairs knife/deflector B=40 mm
- Nr. 1, 3, 5, 9, 13, 18, 20, 21, 23, 28, 32, 36

Set price complete
 Art.: 901015

479,00 €
 EACH



**THE NEW ONLINESHOP
 FOR WOOD CRAFTSMEN!**

24 hours a day, 7 days a week, 365 days a year:

Now you can order equipment, machines, spare parts, consumables, accessories and much more online from the comfort of your home or workshop – without the hassle of opening hours:



www.hokubema.com

APPENDIX

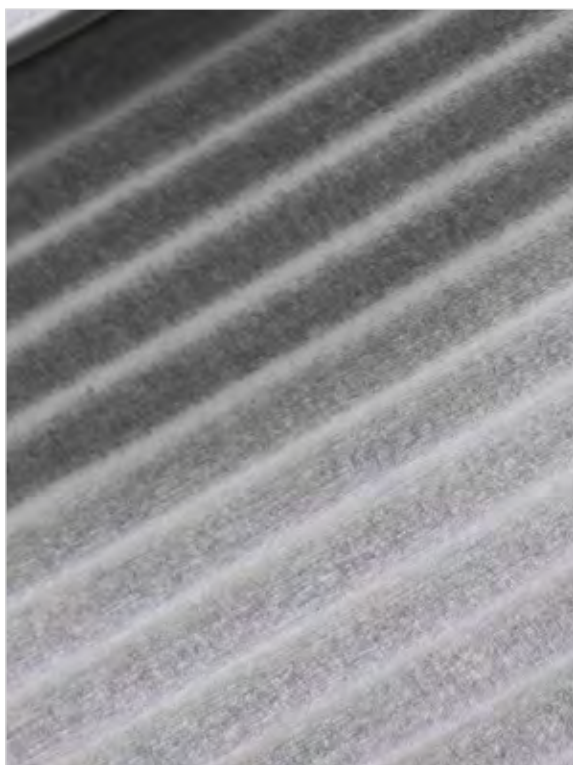
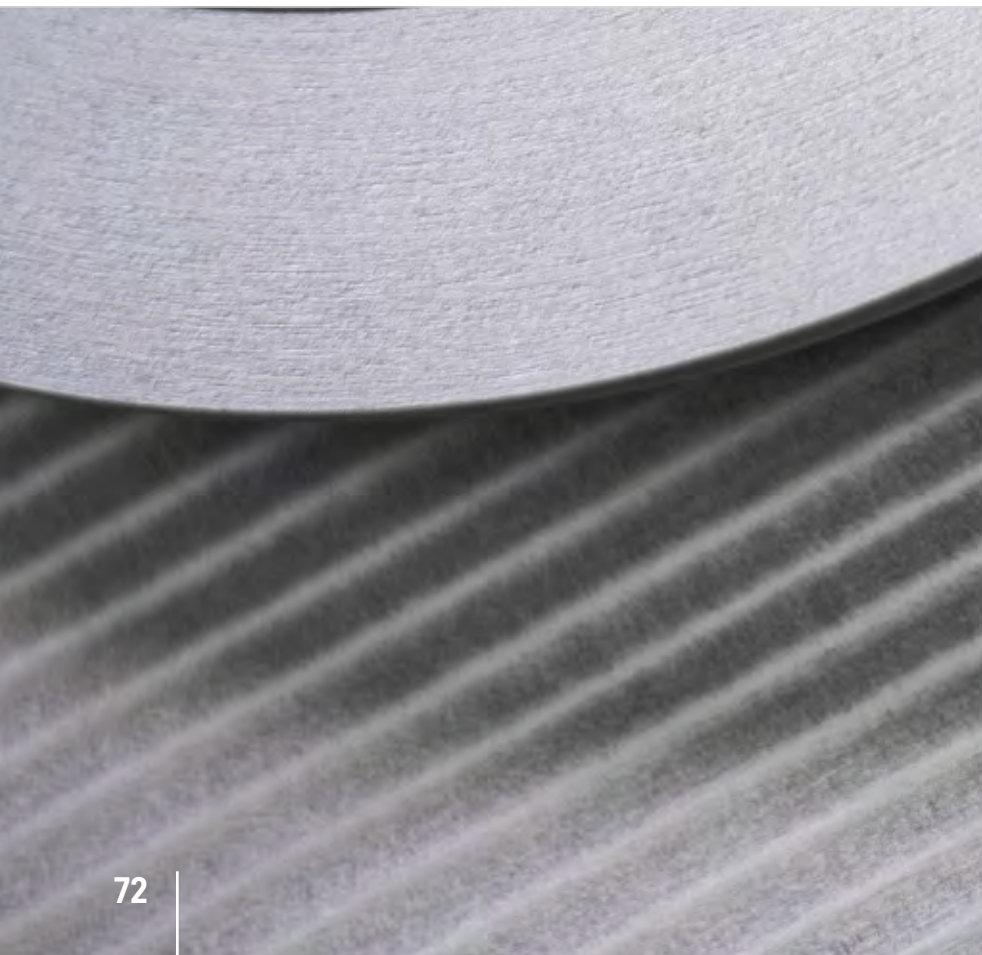

HIGH LEVEL SERVICE AND YOU DECIDE HOW

In our service mindset at HO|KU|BE|MA, accessibility is essential. We simply understand service to mean that you, the customer, are satisfied and can access the information you need in different ways at any time. Sometimes the service by phone, mail or WhatsApp is not enough, in this case we are happy to offer you our on-site service. If required, the on-site service also includes maintenance and repair work on the machines.



ABOUT US P.01

MILLING P.03

PLANNING P.13

BAND SAWS P.27

CIRCULAR SAWS P.39

GENERAL P.49

LIFT TABLES P.55

ACCESSOIRES P.63

APPENDIX P.73

APPENDIX

NOTES	74
MAINTENANCE PLAN	79

NOTES

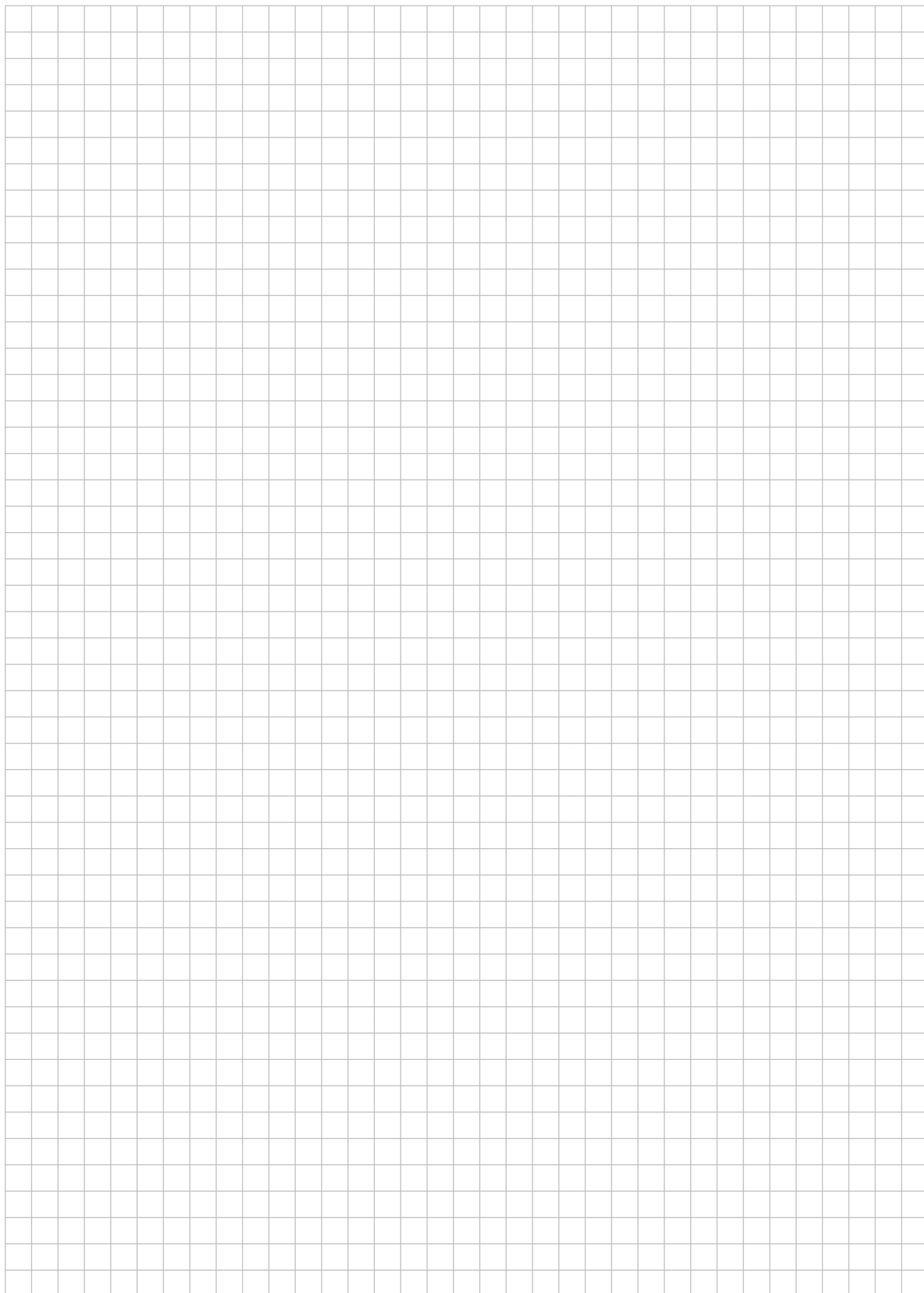

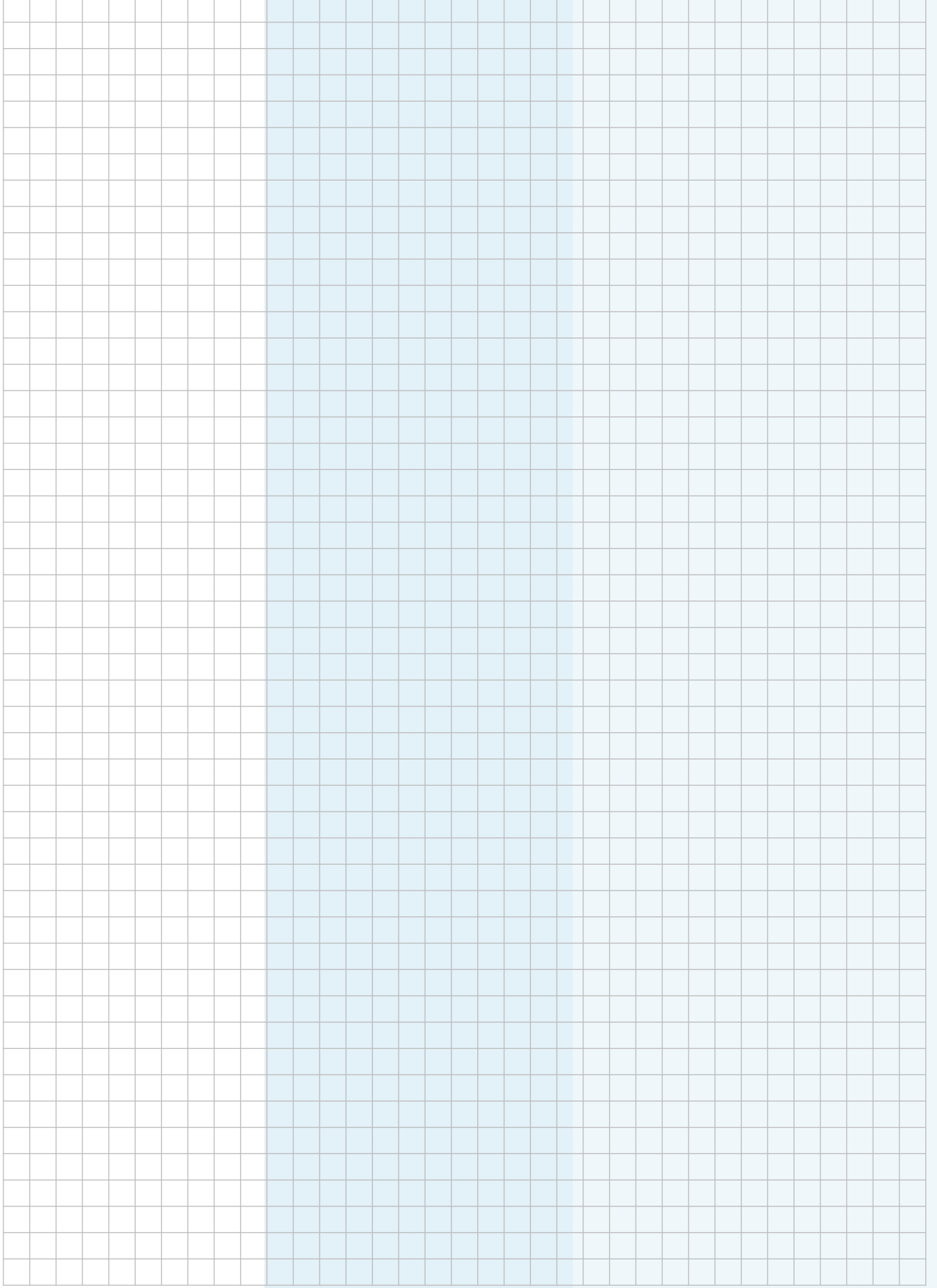

NOTES

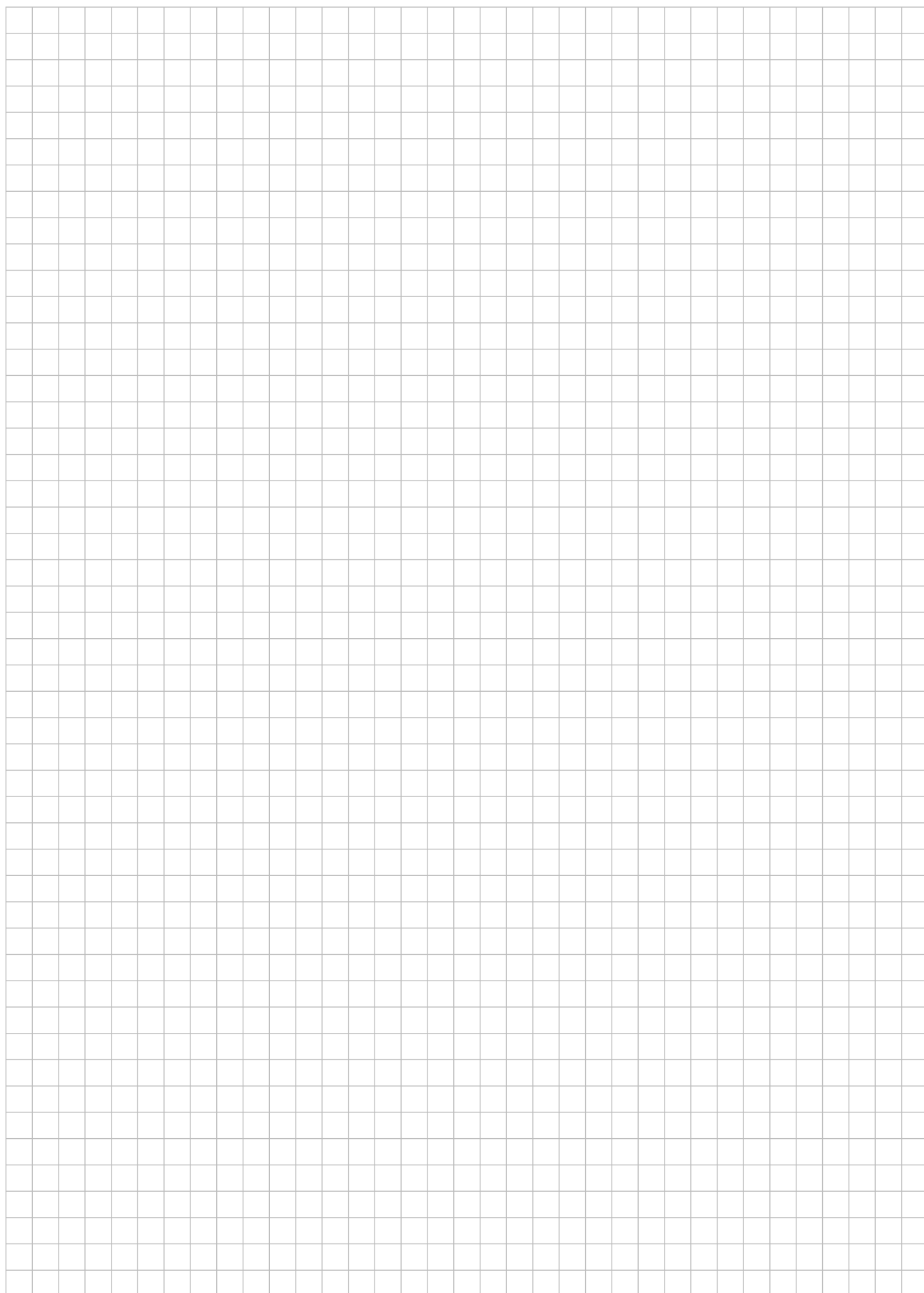

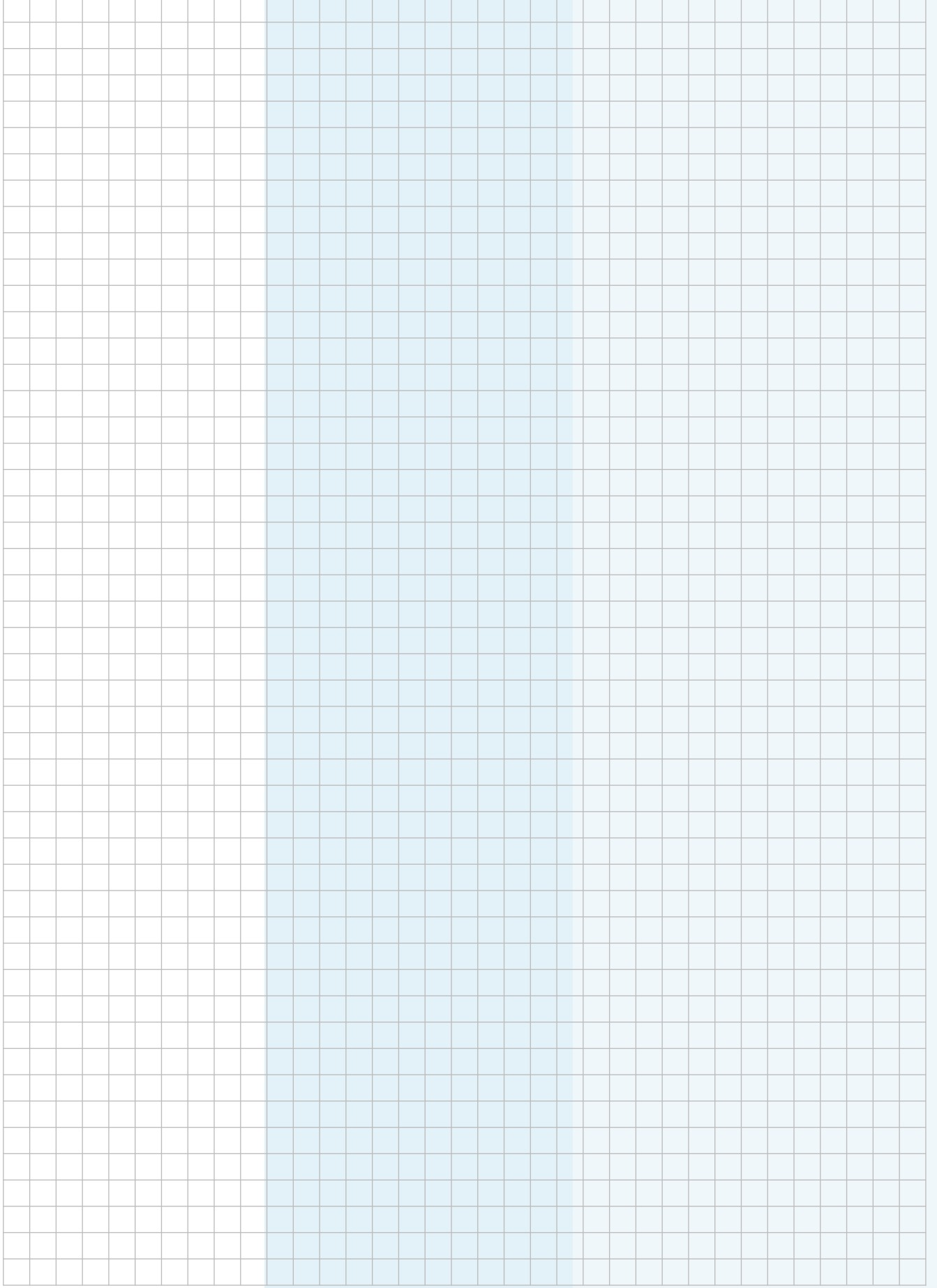

NOTES

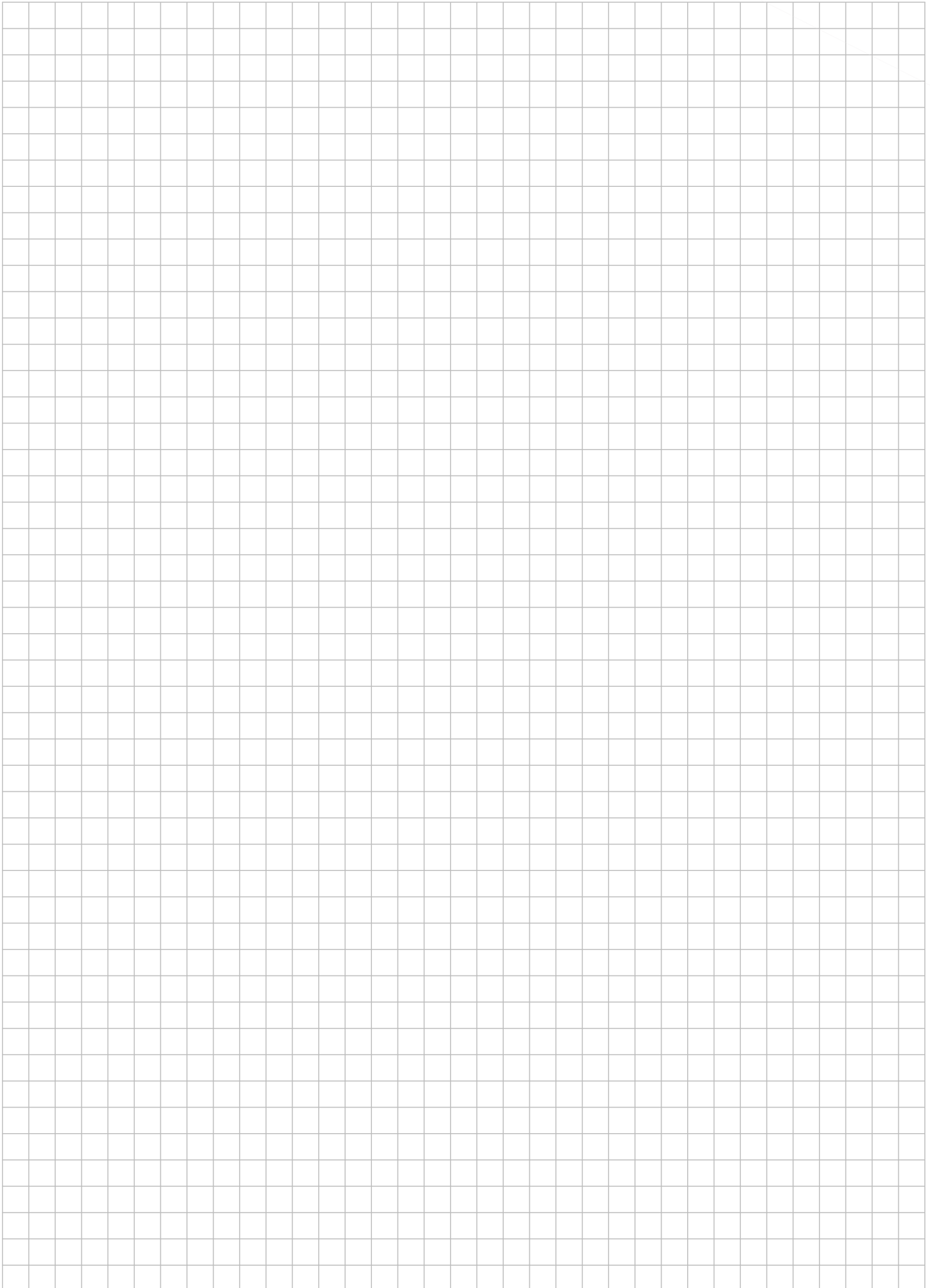

MAINTENANCE PLAN

SERIAL NUMBER

MACHINE TYPE	DATE
--------------	------

TÄTIGKEIT

TÄTIGKEIT	DAILY	WEEKLY	MONTHLY	YEARLY																																																																			
Machine cleaning	<input type="checkbox"/>																																																																						
Dust suction before starting work and checking of all functions	<input type="checkbox"/>																																																																						
Check and remove any impurity from the suction channel	<input type="checkbox"/>																																																																						
Inspect the electrical devices/parts for externally detectable damages and, if necessary, have them fixed by a qualified electrician		<table border="1" style="font-size: 8px; width: 100%; text-align: center;"> <tr><td>1</td><td>2</td><td>3</td><td>4</td><td>5</td><td>6</td><td>7</td><td>8</td></tr> <tr><td>9</td><td>10</td><td>11</td><td>12</td><td>13</td><td>14</td><td>15</td><td>16</td></tr> <tr><td>17</td><td>18</td><td>19</td><td>20</td><td>21</td><td>22</td><td>23</td><td>24</td></tr> <tr><td>25</td><td>26</td><td>27</td><td>28</td><td>29</td><td>30</td><td>31</td><td>32</td></tr> <tr><td>33</td><td>34</td><td>35</td><td>36</td><td>37</td><td>38</td><td>39</td><td>40</td></tr> <tr><td>41</td><td>42</td><td>43</td><td>44</td><td>45</td><td>46</td><td>47</td><td>48</td></tr> <tr><td>49</td><td>50</td><td>51</td><td>52</td><td>53</td><td></td><td></td><td></td></tr> </table>	1	2	3	4	5	6	7	8	9	10	11	12	13	14	15	16	17	18	19	20	21	22	23	24	25	26	27	28	29	30	31	32	33	34	35	36	37	38	39	40	41	42	43	44	45	46	47	48	49	50	51	52	53																
1	2	3	4	5	6	7	8																																																																
9	10	11	12	13	14	15	16																																																																
17	18	19	20	21	22	23	24																																																																
25	26	27	28	29	30	31	32																																																																
33	34	35	36	37	38	39	40																																																																
41	42	43	44	45	46	47	48																																																																
49	50	51	52	53																																																																			
Check conditions and tension of V-ribbed belts			<table border="1" style="font-size: 8px; width: 100%; text-align: center;"> <tr><td>1</td><td>2</td><td>3</td><td>4</td><td>5</td><td>6</td></tr> <tr><td>7</td><td>8</td><td>9</td><td>10</td><td>11</td><td>12</td></tr> </table>	1	2	3	4	5	6	7	8	9	10	11	12																																																								
1	2	3	4	5	6																																																																		
7	8	9	10	11	12																																																																		
Check the smooth running of all sliding or rolling parts and grease them with a thin fluid oil, if necessary Saw <input type="checkbox"/> Spindle moulder <input type="checkbox"/> _____		<table border="1" style="font-size: 8px; width: 100%; text-align: center;"> <tr><td>1</td><td>2</td><td>3</td><td>4</td><td>5</td><td>6</td><td>7</td><td>8</td></tr> <tr><td>9</td><td>10</td><td>11</td><td>12</td><td>13</td><td>14</td><td>15</td><td>16</td></tr> <tr><td>17</td><td>18</td><td>19</td><td>20</td><td>21</td><td>22</td><td>23</td><td>24</td></tr> <tr><td>25</td><td>26</td><td>27</td><td>28</td><td>29</td><td>30</td><td>31</td><td>32</td></tr> <tr><td>33</td><td>34</td><td>35</td><td>36</td><td>37</td><td>38</td><td>39</td><td>40</td></tr> <tr><td>41</td><td>42</td><td>43</td><td>44</td><td>45</td><td>46</td><td>47</td><td>48</td></tr> <tr><td>49</td><td>50</td><td>51</td><td>52</td><td>53</td><td></td><td></td><td></td></tr> </table>	1	2	3	4	5	6	7	8	9	10	11	12	13	14	15	16	17	18	19	20	21	22	23	24	25	26	27	28	29	30	31	32	33	34	35	36	37	38	39	40	41	42	43	44	45	46	47	48	49	50	51	52	53																
1	2	3	4	5	6	7	8																																																																
9	10	11	12	13	14	15	16																																																																
17	18	19	20	21	22	23	24																																																																
25	26	27	28	29	30	31	32																																																																
33	34	35	36	37	38	39	40																																																																
41	42	43	44	45	46	47	48																																																																
49	50	51	52	53																																																																			
Apply some oil drops on the thread of clamping and adjusting levers		<table border="1" style="font-size: 8px; width: 100%; text-align: center;"> <tr><td>1</td><td>2</td><td>3</td><td>4</td><td>5</td><td>6</td><td>7</td><td>8</td></tr> <tr><td>9</td><td>10</td><td>11</td><td>12</td><td>13</td><td>14</td><td>15</td><td>16</td></tr> <tr><td>17</td><td>18</td><td>19</td><td>20</td><td>21</td><td>22</td><td>23</td><td>24</td></tr> <tr><td>25</td><td>26</td><td>27</td><td>28</td><td>29</td><td>30</td><td>31</td><td>32</td></tr> <tr><td>33</td><td>34</td><td>35</td><td>36</td><td>37</td><td>38</td><td>39</td><td>40</td></tr> <tr><td>41</td><td>42</td><td>43</td><td>44</td><td>45</td><td>46</td><td>47</td><td>48</td></tr> <tr><td>49</td><td>50</td><td>51</td><td>52</td><td>53</td><td></td><td></td><td></td></tr> </table>	1	2	3	4	5	6	7	8	9	10	11	12	13	14	15	16	17	18	19	20	21	22	23	24	25	26	27	28	29	30	31	32	33	34	35	36	37	38	39	40	41	42	43	44	45	46	47	48	49	50	51	52	53																
1	2	3	4	5	6	7	8																																																																
9	10	11	12	13	14	15	16																																																																
17	18	19	20	21	22	23	24																																																																
25	26	27	28	29	30	31	32																																																																
33	34	35	36	37	38	39	40																																																																
41	42	43	44	45	46	47	48																																																																
49	50	51	52	53																																																																			
Replace the lubricators of the swivel adjustment Saw <input type="checkbox"/> Spindle moulder <input type="checkbox"/> _____		<table border="1" style="font-size: 8px; width: 100%; text-align: center;"> <tr><td>1</td><td>2</td><td>3</td><td>4</td><td>5</td><td>6</td><td>7</td><td>8</td></tr> <tr><td>9</td><td>10</td><td>11</td><td>12</td><td>13</td><td>14</td><td>15</td><td>16</td></tr> <tr><td>17</td><td>18</td><td>19</td><td>20</td><td>21</td><td>22</td><td>23</td><td>24</td></tr> <tr><td>25</td><td>26</td><td>27</td><td>28</td><td>29</td><td>30</td><td>31</td><td>32</td></tr> <tr><td>33</td><td>34</td><td>35</td><td>36</td><td>37</td><td>38</td><td>39</td><td>40</td></tr> <tr><td>41</td><td>42</td><td>43</td><td>44</td><td>45</td><td>46</td><td>47</td><td>48</td></tr> <tr><td>49</td><td>50</td><td>51</td><td>52</td><td>53</td><td></td><td></td><td></td></tr> </table>	1	2	3	4	5	6	7	8	9	10	11	12	13	14	15	16	17	18	19	20	21	22	23	24	25	26	27	28	29	30	31	32	33	34	35	36	37	38	39	40	41	42	43	44	45	46	47	48	49	50	51	52	53																
1	2	3	4	5	6	7	8																																																																
9	10	11	12	13	14	15	16																																																																
17	18	19	20	21	22	23	24																																																																
25	26	27	28	29	30	31	32																																																																
33	34	35	36	37	38	39	40																																																																
41	42	43	44	45	46	47	48																																																																
49	50	51	52	53																																																																			
Replace tool and check for its functionality Saw <input type="checkbox"/> Spindle moulder <input type="checkbox"/> _____		<table border="1" style="font-size: 8px; width: 100%; text-align: center;"> <tr><td>1</td><td>2</td><td>3</td><td>4</td><td>5</td><td>6</td><td>7</td><td>8</td></tr> <tr><td>9</td><td>10</td><td>11</td><td>12</td><td>13</td><td>14</td><td>15</td><td>16</td></tr> <tr><td>17</td><td>18</td><td>19</td><td>20</td><td>21</td><td>22</td><td>23</td><td>24</td></tr> <tr><td>25</td><td>26</td><td>27</td><td>28</td><td>29</td><td>30</td><td>31</td><td>32</td></tr> <tr><td>33</td><td>34</td><td>35</td><td>36</td><td>37</td><td>38</td><td>39</td><td>40</td></tr> <tr><td>41</td><td>42</td><td>43</td><td>44</td><td>45</td><td>46</td><td>47</td><td>48</td></tr> <tr><td>49</td><td>50</td><td>51</td><td>52</td><td>53</td><td></td><td></td><td></td></tr> </table>	1	2	3	4	5	6	7	8	9	10	11	12	13	14	15	16	17	18	19	20	21	22	23	24	25	26	27	28	29	30	31	32	33	34	35	36	37	38	39	40	41	42	43	44	45	46	47	48	49	50	51	52	53																
1	2	3	4	5	6	7	8																																																																
9	10	11	12	13	14	15	16																																																																
17	18	19	20	21	22	23	24																																																																
25	26	27	28	29	30	31	32																																																																
33	34	35	36	37	38	39	40																																																																
41	42	43	44	45	46	47	48																																																																
49	50	51	52	53																																																																			
Remove resin and wood residues from the pivoting segments and grease them with a thin fluid oil (e.g. Neoval, Red Oil) Saw <input type="checkbox"/> Spindle moulder <input type="checkbox"/> _____		<table border="1" style="font-size: 8px; width: 100%; text-align: center;"> <tr><td>1</td><td>2</td><td>3</td><td>4</td><td>5</td><td>6</td><td>7</td><td>8</td></tr> <tr><td>9</td><td>10</td><td>11</td><td>12</td><td>13</td><td>14</td><td>15</td><td>16</td></tr> <tr><td>17</td><td>18</td><td>19</td><td>20</td><td>21</td><td>22</td><td>23</td><td>24</td></tr> <tr><td>25</td><td>26</td><td>27</td><td>28</td><td>29</td><td>30</td><td>31</td><td>32</td></tr> <tr><td>33</td><td>34</td><td>35</td><td>36</td><td>37</td><td>38</td><td>39</td><td>40</td></tr> <tr><td>41</td><td>42</td><td>43</td><td>44</td><td>45</td><td>46</td><td>47</td><td>48</td></tr> <tr><td>49</td><td>50</td><td>51</td><td>52</td><td>53</td><td></td><td></td><td></td></tr> </table>	1	2	3	4	5	6	7	8	9	10	11	12	13	14	15	16	17	18	19	20	21	22	23	24	25	26	27	28	29	30	31	32	33	34	35	36	37	38	39	40	41	42	43	44	45	46	47	48	49	50	51	52	53																
1	2	3	4	5	6	7	8																																																																
9	10	11	12	13	14	15	16																																																																
17	18	19	20	21	22	23	24																																																																
25	26	27	28	29	30	31	32																																																																
33	34	35	36	37	38	39	40																																																																
41	42	43	44	45	46	47	48																																																																
49	50	51	52	53																																																																			
Grease the milling spindle bearing at the indicated point Saw <input type="checkbox"/> Spindle moulder <input type="checkbox"/> Planning machine <input type="checkbox"/> _____			<table border="1" style="font-size: 8px; width: 100%; text-align: center;"> <tr><td>1</td><td>2</td><td>3</td><td>4</td><td>5</td><td>6</td></tr> <tr><td>7</td><td>8</td><td>9</td><td>10</td><td>11</td><td>12</td></tr> </table>	1	2	3	4	5	6	7	8	9	10	11	12																																																								
1	2	3	4	5	6																																																																		
7	8	9	10	11	12																																																																		
Check shaper fence for damages and have the damaged parts replaced if any			<table border="1" style="font-size: 8px; width: 100%; text-align: center;"> <tr><td>1</td><td>2</td><td>3</td><td>4</td><td>5</td><td>6</td></tr> <tr><td>7</td><td>8</td><td>9</td><td>10</td><td>11</td><td>12</td></tr> </table>	1	2	3	4	5	6	7	8	9	10	11	12																																																								
1	2	3	4	5	6																																																																		
7	8	9	10	11	12																																																																		
Clean the guideways of the sliding table		<table border="1" style="font-size: 8px; width: 100%; text-align: center;"> <tr><td>1</td><td>2</td><td>3</td><td>4</td><td>5</td><td>6</td><td>7</td><td>8</td></tr> <tr><td>9</td><td>10</td><td>11</td><td>12</td><td>13</td><td>14</td><td>15</td><td>16</td></tr> <tr><td>17</td><td>18</td><td>19</td><td>20</td><td>21</td><td>22</td><td>23</td><td>24</td></tr> <tr><td>25</td><td>26</td><td>27</td><td>28</td><td>29</td><td>30</td><td>31</td><td>32</td></tr> <tr><td>33</td><td>34</td><td>35</td><td>36</td><td>37</td><td>38</td><td>39</td><td>40</td></tr> <tr><td>41</td><td>42</td><td>43</td><td>44</td><td>45</td><td>46</td><td>47</td><td>48</td></tr> <tr><td>49</td><td>50</td><td>51</td><td>52</td><td>53</td><td></td><td></td><td></td></tr> </table>	1	2	3	4	5	6	7	8	9	10	11	12	13	14	15	16	17	18	19	20	21	22	23	24	25	26	27	28	29	30	31	32	33	34	35	36	37	38	39	40	41	42	43	44	45	46	47	48	49	50	51	52	53																
1	2	3	4	5	6	7	8																																																																
9	10	11	12	13	14	15	16																																																																
17	18	19	20	21	22	23	24																																																																
25	26	27	28	29	30	31	32																																																																
33	34	35	36	37	38	39	40																																																																
41	42	43	44	45	46	47	48																																																																
49	50	51	52	53																																																																			
		<table border="1" style="font-size: 8px; width: 100%; text-align: center;"> <tr><td>1</td><td>2</td><td>3</td><td>4</td><td>5</td><td>6</td><td>7</td><td>8</td></tr> <tr><td>9</td><td>10</td><td>11</td><td>12</td><td>13</td><td>14</td><td>15</td><td>16</td></tr> <tr><td>17</td><td>18</td><td>19</td><td>20</td><td>21</td><td>22</td><td>23</td><td>24</td></tr> <tr><td>25</td><td>26</td><td>27</td><td>28</td><td>29</td><td>30</td><td>31</td><td>32</td></tr> <tr><td>33</td><td>34</td><td>35</td><td>36</td><td>37</td><td>38</td><td>39</td><td>40</td></tr> <tr><td>41</td><td>42</td><td>43</td><td>44</td><td>45</td><td>46</td><td>47</td><td>48</td></tr> <tr><td>49</td><td>50</td><td>51</td><td>52</td><td>53</td><td></td><td></td><td></td></tr> </table>	1	2	3	4	5	6	7	8	9	10	11	12	13	14	15	16	17	18	19	20	21	22	23	24	25	26	27	28	29	30	31	32	33	34	35	36	37	38	39	40	41	42	43	44	45	46	47	48	49	50	51	52	53				<table border="1" style="font-size: 8px; width: 100%; text-align: center;"> <tr><td>1</td><td>2</td><td>3</td><td>4</td><td>5</td><td>6</td></tr> <tr><td>7</td><td>8</td><td>9</td><td>10</td><td>11</td><td>12</td></tr> </table>	1	2	3	4	5	6	7	8	9	10	11	12
1	2	3	4	5	6	7	8																																																																
9	10	11	12	13	14	15	16																																																																
17	18	19	20	21	22	23	24																																																																
25	26	27	28	29	30	31	32																																																																
33	34	35	36	37	38	39	40																																																																
41	42	43	44	45	46	47	48																																																																
49	50	51	52	53																																																																			
1	2	3	4	5	6																																																																		
7	8	9	10	11	12																																																																		

SERVICE TECHNICIAN	NEXT MAINTENANCE	
SIGNATURE		

MADE IN GERMANY

MAINTENANCE PLAN

HOKUBEMA

SERIAL NUMBER

MACHINE TYPE THICKNESS PLANER | TWINPLAN | SURFACE PLANER **DATE**

ACTION	DAILY	WEEKLY	MONTHLY	YEARLY																																																																				
	Check knife shaft protection function																																																																							
Machine cleaning																																																																								
Check that the suction system is fully functional before starting work																																																																								
Check and clean the suction channel from deposits.																																																																								
Inspect electrical equipment/components for externally visible damage and have damage repaired by a qualified electrician if necessary.		<table border="1"> <tr><td>1</td><td>2</td><td>3</td><td>4</td><td>5</td><td>6</td><td>7</td><td>8</td></tr> <tr><td>9</td><td>10</td><td>11</td><td>12</td><td>13</td><td>14</td><td>15</td><td>16</td></tr> <tr><td>17</td><td>18</td><td>19</td><td>20</td><td>21</td><td>22</td><td>23</td><td>24</td></tr> <tr><td>25</td><td>26</td><td>27</td><td>28</td><td>29</td><td>30</td><td>31</td><td>32</td></tr> <tr><td>33</td><td>34</td><td>35</td><td>36</td><td>37</td><td>38</td><td>39</td><td>40</td></tr> <tr><td>41</td><td>42</td><td>43</td><td>44</td><td>45</td><td>46</td><td>47</td><td>48</td></tr> <tr><td>49</td><td>50</td><td>51</td><td>52</td><td>53</td><td></td><td></td><td></td></tr> </table>	1	2	3	4	5	6	7	8	9	10	11	12	13	14	15	16	17	18	19	20	21	22	23	24	25	26	27	28	29	30	31	32	33	34	35	36	37	38	39	40	41	42	43	44	45	46	47	48	49	50	51	52	53																	
1	2	3	4	5	6	7	8																																																																	
9	10	11	12	13	14	15	16																																																																	
17	18	19	20	21	22	23	24																																																																	
25	26	27	28	29	30	31	32																																																																	
33	34	35	36	37	38	39	40																																																																	
41	42	43	44	45	46	47	48																																																																	
49	50	51	52	53																																																																				
Check all sliding or rolling parts for smooth running and if necessary, lubricate them with a thin lubricate		<table border="1"> <tr><td>1</td><td>2</td><td>3</td><td>4</td><td>5</td><td>6</td><td>7</td><td>8</td></tr> <tr><td>9</td><td>10</td><td>11</td><td>12</td><td>13</td><td>14</td><td>15</td><td>16</td></tr> <tr><td>17</td><td>18</td><td>19</td><td>20</td><td>21</td><td>22</td><td>23</td><td>24</td></tr> <tr><td>25</td><td>26</td><td>27</td><td>28</td><td>29</td><td>30</td><td>31</td><td>32</td></tr> <tr><td>33</td><td>34</td><td>35</td><td>36</td><td>37</td><td>38</td><td>39</td><td>40</td></tr> <tr><td>41</td><td>42</td><td>43</td><td>44</td><td>45</td><td>46</td><td>47</td><td>48</td></tr> <tr><td>49</td><td>50</td><td>51</td><td>52</td><td>53</td><td></td><td></td><td></td></tr> </table>	1	2	3	4	5	6	7	8	9	10	11	12	13	14	15	16	17	18	19	20	21	22	23	24	25	26	27	28	29	30	31	32	33	34	35	36	37	38	39	40	41	42	43	44	45	46	47	48	49	50	51	52	53																	
1	2	3	4	5	6	7	8																																																																	
9	10	11	12	13	14	15	16																																																																	
17	18	19	20	21	22	23	24																																																																	
25	26	27	28	29	30	31	32																																																																	
33	34	35	36	37	38	39	40																																																																	
41	42	43	44	45	46	47	48																																																																	
49	50	51	52	53																																																																				
Main motor brake function test (brake under 10 sec) Thickness Planer <input type="checkbox"/> Surface Planer <input type="checkbox"/>		<table border="1"> <tr><td>1</td><td>2</td><td>3</td><td>4</td><td>5</td><td>6</td><td>7</td><td>8</td></tr> <tr><td>9</td><td>10</td><td>11</td><td>12</td><td>13</td><td>14</td><td>15</td><td>16</td></tr> <tr><td>17</td><td>18</td><td>19</td><td>20</td><td>21</td><td>22</td><td>23</td><td>24</td></tr> <tr><td>25</td><td>26</td><td>27</td><td>28</td><td>29</td><td>30</td><td>31</td><td>32</td></tr> <tr><td>33</td><td>34</td><td>35</td><td>36</td><td>37</td><td>38</td><td>39</td><td>40</td></tr> <tr><td>41</td><td>42</td><td>43</td><td>44</td><td>45</td><td>46</td><td>47</td><td>48</td></tr> <tr><td>49</td><td>50</td><td>51</td><td>52</td><td>53</td><td></td><td></td><td></td></tr> </table>	1	2	3	4	5	6	7	8	9	10	11	12	13	14	15	16	17	18	19	20	21	22	23	24	25	26	27	28	29	30	31	32	33	34	35	36	37	38	39	40	41	42	43	44	45	46	47	48	49	50	51	52	53																	
1	2	3	4	5	6	7	8																																																																	
9	10	11	12	13	14	15	16																																																																	
17	18	19	20	21	22	23	24																																																																	
25	26	27	28	29	30	31	32																																																																	
33	34	35	36	37	38	39	40																																																																	
41	42	43	44	45	46	47	48																																																																	
49	50	51	52	53																																																																				
Check the planer fence for damage and if necessary (have) the damaged parts replaced			<table border="1"> <tr><td>1</td><td>2</td><td>3</td><td>4</td><td>5</td><td>6</td></tr> <tr><td>7</td><td>8</td><td>9</td><td>10</td><td>11</td><td>12</td></tr> </table>	1	2	3	4	5	6	7	8	9	10	11	12																																																									
1	2	3	4	5	6																																																																			
7	8	9	10	11	12																																																																			
Grease the spindles + guideway Twinplan <input type="checkbox"/> Thickness Planer <input type="checkbox"/>			<table border="1"> <tr><td>1</td><td>2</td><td>3</td><td>4</td><td>5</td><td>6</td></tr> <tr><td>7</td><td>8</td><td>9</td><td>10</td><td>11</td><td>12</td></tr> </table>	1	2	3	4	5	6	7	8	9	10	11	12																																																									
1	2	3	4	5	6																																																																			
7	8	9	10	11	12																																																																			
Grease feed table adjustment Twinplan <input type="checkbox"/>																																																																								
Knife shaft cleaning Thickness Planer <input type="checkbox"/> Twinplaner <input type="checkbox"/> Surface Planer <input type="checkbox"/>			<table border="1"> <tr><td>1</td><td>2</td><td>3</td><td>4</td><td>5</td><td>6</td></tr> <tr><td>7</td><td>8</td><td>9</td><td>10</td><td>11</td><td>12</td></tr> </table>	1	2	3	4	5	6	7	8	9	10	11	12																																																									
1	2	3	4	5	6																																																																			
7	8	9	10	11	12																																																																			
Check chain and V-belt tension, replace if necessary																																																																								
		<table border="1"> <tr><td>1</td><td>2</td><td>3</td><td>4</td><td>5</td><td>6</td><td>7</td><td>8</td></tr> <tr><td>9</td><td>10</td><td>11</td><td>12</td><td>13</td><td>14</td><td>15</td><td>16</td></tr> <tr><td>17</td><td>18</td><td>19</td><td>20</td><td>21</td><td>22</td><td>23</td><td>24</td></tr> <tr><td>25</td><td>26</td><td>27</td><td>28</td><td>29</td><td>30</td><td>31</td><td>32</td></tr> <tr><td>33</td><td>34</td><td>35</td><td>36</td><td>37</td><td>38</td><td>39</td><td>40</td></tr> <tr><td>41</td><td>42</td><td>43</td><td>44</td><td>45</td><td>46</td><td>47</td><td>48</td></tr> <tr><td>49</td><td>50</td><td>51</td><td>52</td><td>53</td><td></td><td></td><td></td></tr> </table>	1	2	3	4	5	6	7	8	9	10	11	12	13	14	15	16	17	18	19	20	21	22	23	24	25	26	27	28	29	30	31	32	33	34	35	36	37	38	39	40	41	42	43	44	45	46	47	48	49	50	51	52	53				<table border="1"> <tr><td>1</td><td>2</td><td>3</td><td>4</td><td>5</td><td>6</td></tr> <tr><td>7</td><td>8</td><td>9</td><td>10</td><td>11</td><td>12</td></tr> </table>	1	2	3	4	5	6	7	8	9	10	11	12	
1	2	3	4	5	6	7	8																																																																	
9	10	11	12	13	14	15	16																																																																	
17	18	19	20	21	22	23	24																																																																	
25	26	27	28	29	30	31	32																																																																	
33	34	35	36	37	38	39	40																																																																	
41	42	43	44	45	46	47	48																																																																	
49	50	51	52	53																																																																				
1	2	3	4	5	6																																																																			
7	8	9	10	11	12																																																																			
		<table border="1"> <tr><td>1</td><td>2</td><td>3</td><td>4</td><td>5</td><td>6</td><td>7</td><td>8</td></tr> <tr><td>9</td><td>10</td><td>11</td><td>12</td><td>13</td><td>14</td><td>15</td><td>16</td></tr> <tr><td>17</td><td>18</td><td>19</td><td>20</td><td>21</td><td>22</td><td>23</td><td>24</td></tr> <tr><td>25</td><td>26</td><td>27</td><td>28</td><td>29</td><td>30</td><td>31</td><td>32</td></tr> <tr><td>33</td><td>34</td><td>35</td><td>36</td><td>37</td><td>38</td><td>39</td><td>40</td></tr> <tr><td>41</td><td>42</td><td>43</td><td>44</td><td>45</td><td>46</td><td>47</td><td>48</td></tr> <tr><td>49</td><td>50</td><td>51</td><td>52</td><td>53</td><td></td><td></td><td></td></tr> </table>	1	2	3	4	5	6	7	8	9	10	11	12	13	14	15	16	17	18	19	20	21	22	23	24	25	26	27	28	29	30	31	32	33	34	35	36	37	38	39	40	41	42	43	44	45	46	47	48	49	50	51	52	53				<table border="1"> <tr><td>1</td><td>2</td><td>3</td><td>4</td><td>5</td><td>6</td></tr> <tr><td>7</td><td>8</td><td>9</td><td>10</td><td>11</td><td>12</td></tr> </table>	1	2	3	4	5	6	7	8	9	10	11	12	
1	2	3	4	5	6	7	8																																																																	
9	10	11	12	13	14	15	16																																																																	
17	18	19	20	21	22	23	24																																																																	
25	26	27	28	29	30	31	32																																																																	
33	34	35	36	37	38	39	40																																																																	
41	42	43	44	45	46	47	48																																																																	
49	50	51	52	53																																																																				
1	2	3	4	5	6																																																																			
7	8	9	10	11	12																																																																			
		<table border="1"> <tr><td>1</td><td>2</td><td>3</td><td>4</td><td>5</td><td>6</td><td>7</td><td>8</td></tr> <tr><td>9</td><td>10</td><td>11</td><td>12</td><td>13</td><td>14</td><td>15</td><td>16</td></tr> <tr><td>17</td><td>18</td><td>19</td><td>20</td><td>21</td><td>22</td><td>23</td><td>24</td></tr> <tr><td>25</td><td>26</td><td>27</td><td>28</td><td>29</td><td>30</td><td>31</td><td>32</td></tr> <tr><td>33</td><td>34</td><td>35</td><td>36</td><td>37</td><td>38</td><td>39</td><td>40</td></tr> <tr><td>41</td><td>42</td><td>43</td><td>44</td><td>45</td><td>46</td><td>47</td><td>48</td></tr> <tr><td>49</td><td>50</td><td>51</td><td>52</td><td>53</td><td></td><td></td><td></td></tr> </table>	1	2	3	4	5	6	7	8	9	10	11	12	13	14	15	16	17	18	19	20	21	22	23	24	25	26	27	28	29	30	31	32	33	34	35	36	37	38	39	40	41	42	43	44	45	46	47	48	49	50	51	52	53				<table border="1"> <tr><td>1</td><td>2</td><td>3</td><td>4</td><td>5</td><td>6</td></tr> <tr><td>7</td><td>8</td><td>9</td><td>10</td><td>11</td><td>12</td></tr> </table>	1	2	3	4	5	6	7	8	9	10	11	12	
1	2	3	4	5	6	7	8																																																																	
9	10	11	12	13	14	15	16																																																																	
17	18	19	20	21	22	23	24																																																																	
25	26	27	28	29	30	31	32																																																																	
33	34	35	36	37	38	39	40																																																																	
41	42	43	44	45	46	47	48																																																																	
49	50	51	52	53																																																																				
1	2	3	4	5	6																																																																			
7	8	9	10	11	12																																																																			

SERVICE TECHNICIAN

SIGNATURE

NEXT MAINTENANCE



MADE IN GERMANY



HOKUBEMA

JAHRE

Maschinenbau GmbH





Der Onlineshop für Holz-Handwerker

HOKUBEMA bietet den Onlineshop für Ihre Werkstatt, die Schreinerei, den Hobbykeller.

Bei uns finden Sie bequem und jederzeit alle Ersatzteile für Ihre PANHANS-Maschinen. Daneben können Sie sich aber auch jegliche Produkte aus unserer Sparte SI-TEC (Sicherheitstechnik) für Ihren täglichen Einsatz an Ihren Holzbearbeitungsmaschinen bestellen.

Sie haben bereits eine kleine Werkstatt, nur die Maschinen fehlen noch? Kein Problem: Bestellen Sie sich doch eine unserer WOODPECKER-Maschinen. Ergonomie ist uns sehr wichtig, damit Sie auch im Alter beschwerdefrei leben können. Produkte wie Hub- und Arbeitstische finden Sie unter BECK Maschinenbau.

SICHERHEITSTECHNIK

ZU DEN PRODUKTEN

SI TEC
SICHERHEITSTECHNIK

NEW!!!

Produkt-Highlights von HOKUBEMA

HOKUBEMA

SHOP

www.hokubema.com

SEVERAL PRODUCTS
& GOOD PRICES FOR
WOOD CRAFTSMEN

THE NEW ONLINESHOP
FOR WOOD CRAFTSMEN!

MADE IN GERMANY

HOKUBEMA Maschinenbau GmbH
Anton-Günther-Straße 3-7
D-72488 Sigmaringen
Phone: +49 (0)7571 755-0
info@hokubema-panhans.de
www.panhans.de

Reinhold Beck Maschinenbau GmbH
Im Grund 23
D-72505 Krauchenwies
Phone: +49 (0)7576 962978-0
info@beck-maschinenbau.de
www.beck-maschinenbau.de

