

## Basic Description of the Machine



DYNAMIC compact machining centre is determined for surface and form machining by the means of milling and drilling. The centre is used mainly for the machining of models, forms, furniture parts, stairs and wherever there is the need for accurate and productive machining of wood and other similar materials, of plastics, composites, Al alloys etc.

The modular construction of the machine makes it possible to adjust the machine for certain type of production. Its versatility, engineering characteristics, wide range of equipment and accessories make it possible to cover a wide spectrum of production processes and enable quick adjustment for different type of products.

## Dimensional Modifications of the Machine in the Axes X and Y

Dimensional Modifications of the Work Table			
	DYNAMIC (L x W)	DYNAMIC MAX (L x W)	DYNAMIC SUPER MAX (L x W)
FC3000CNC	3000 x 1500	3000 x 2220	3000 x 2700
FC4000CNC	4000 x 1500	4000 x 2220	4000 x 2700
FC5000CNC	5000 x 1500	5000 x 2220	5000 x 2700
FC6000CNC	6000 x 1500	6000 x 2220	6000 x 2700

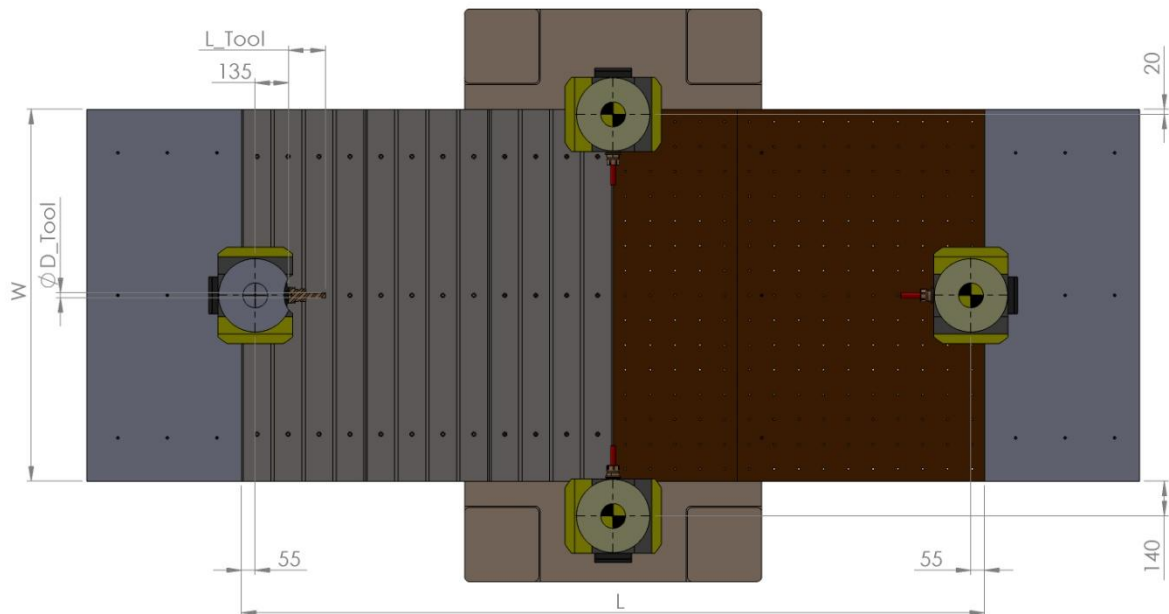

DYNAMIC FC3000CNC 5X

The picture shows the maximal dimensions of the work piece in the axes X and Y for the particular modification of the machine either in the 3 NC axes or 5 NC axes variant. For example, the maximal dimensions of the work piece for the FC3000CNC 5X machine can be expressed in the following formula:

FC3000CNC 5X (L_Tool = 150; D_Tool = 20)	
3X	max. length of the work piece = $L - 2 \times 55 - D\_Tool = 3000 - 2 \times 55 - 20 = \mathbf{2870 \text{ mm}}$
	max. width of the work piece = $W - 20 - D\_Tool / 2 = 1500 - 20 - 20 / 2 = \mathbf{1470 \text{ mm}}$
5X	max. length of the work piece = $L - 2 \times 55 - 2 \times 135 - 2 \times L\_Tool = 3000 - 2 \times 55 - 2 \times 135 - 2 \times 150 = \mathbf{2320 \text{ mm}}$
	max. width of the work piece = $W - 20 + 140 - 2 \times 135 - 2 \times L\_Tool = 1500 - 20 + 140 - 2 \times 135 - 2 \times 150 = \mathbf{1050 \text{ mm}}$

## Dimensional Modifications of the Machine in the Axis Z

	STANDARD		HIGH		SUPER HIGH	
	H1 KARTIT	H2 CAST IRON	H1 KARTIT	H2 CAST IRON	H1 KARTIT	H2 CAST IRON
3X Machine	808	776	1048	1016	1458	1426
5X Machine	816	784	1056	1024	1466	1434

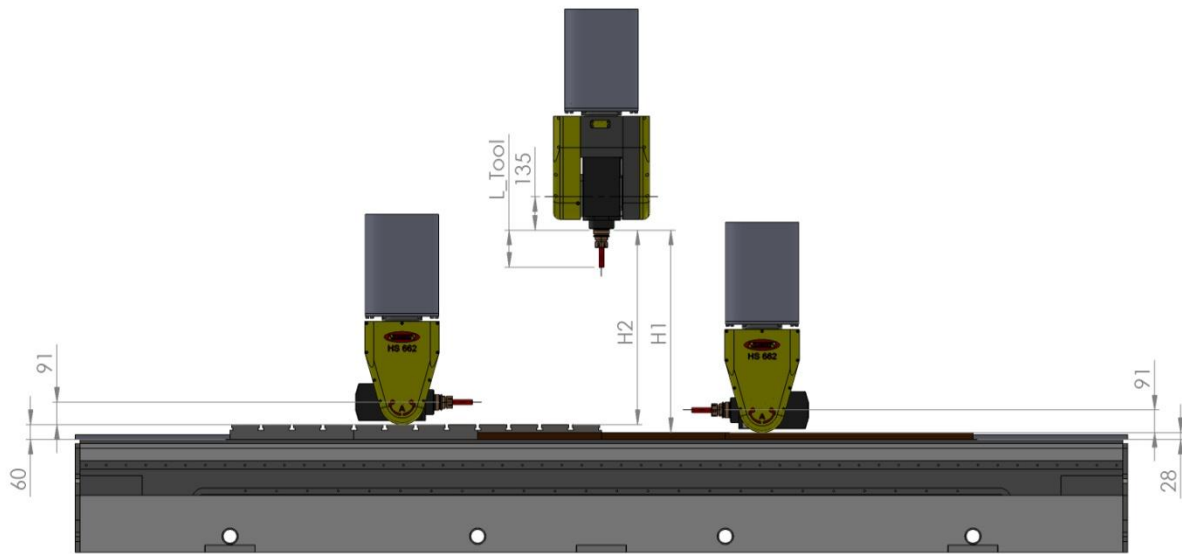

DYNAMIC FC3000CNC 5X

## 3 NC Axes Modification

The machine is in a 3-axis type fitted with a precision hand-adjustable tilting head (3 NC axes X, Y, Z + 2 manual axes A, C). This allows for smooth tilting spindles in two angular axes. This can be achieved by tilting the spindle into any vector. For easy setting up of the angle the head is equipped with a (nonius) scale. Locking of the set angle is then carried out by mechanical reinforcements. This solution ensures high rigidity of the entire system.

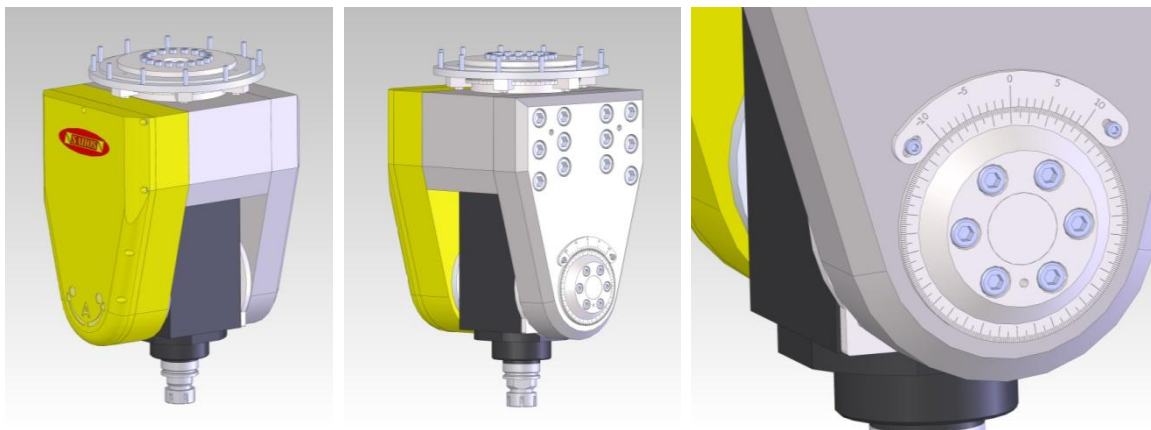

Head with manual tilting in 2 axes (3 NC axes X, Y, Z + 2 manual axes A, C), electro-spindle ES779		
Working range in axis A	°	±110
Working range in axis C	°	±400
Clamping cone		HSK F 63
Revolutions per minute	rpm	0 – 24000
Output of spindle S6 (S1)	kW	12 (10)
Torque S6 (S1)	Nm	15,3 (12,7)
Cone	HSK	F63
Orientation maximum diameter for threading of Al alloys		M16

High-efficiency electro-spindle with water cooling and pneumatic-release tool is fitted with ceramic bearings. Spindle can be equipped with a position sensor for automatic threading.

On the following picture, the power curve of the spindle is shown. Its course is optimized for the use of large diameter tools (profile and folding heads, circular saw blade).

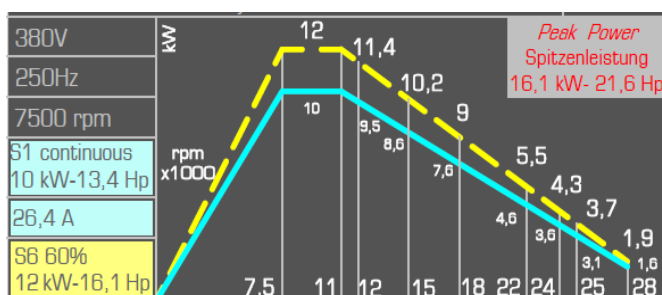

## 5 NC Axes Modification

In 5-axis design, the machine is fitted with a precise automatic **swinging and rotating head HS 662** (5 NC axes X, Y, Z, A, C). This allows fast and precise tilting of the spindle for indexed machining in 3 axes or continuous 5-axis machining. The Head is by default fitted with pneumatic lock system for of the A axis, which is used mainly in the index machining of Al alloys. When required, the Head can be delivered with absolute direct measuring HEIDENHAIN.



Swinging and rotating head HS662 with spindle ES 779		
Working range in axis A	°	±110
Working range in axis C	°	±400
Max. speed in axis A/C	°/min	13000/13000
Servomotor axis A/C	Nm	1,5/5,2
Revolutions per minute	rpm	0 – 24000
Output of spindle S6 (S1)	kW	12 (10)
Torque S6 (S1)	Nm	15,3 (12,7)
Cone	HSK	F63
Orientation maximum diameter for threading of Al alloys		M16

High-efficiency electro-spindle with water cooling and pneumatic-release tool is fitted with ceramic bearings. Spindle can be equipped with a position sensor for automatic threading. On the following picture, the power curve of the spindle is shown. Its course is optimized for the use of large diameter tools (profile and folding heads, circular saw blades).

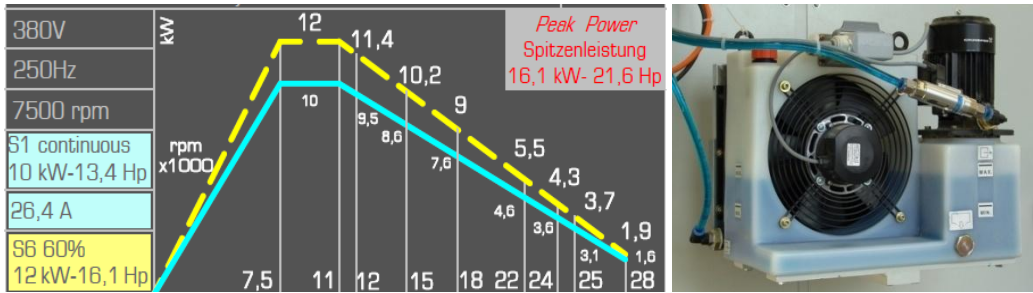

For exact determination of the possibilities of the machining with respect to alignment and dimensions, the following picture shows accurate parameters of the HS662 Head with and without direct measuring.

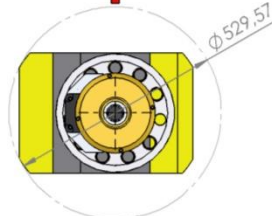
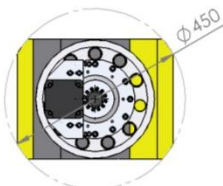
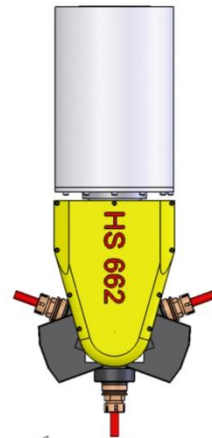
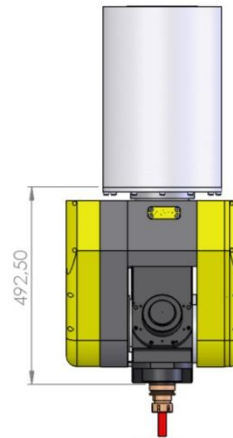
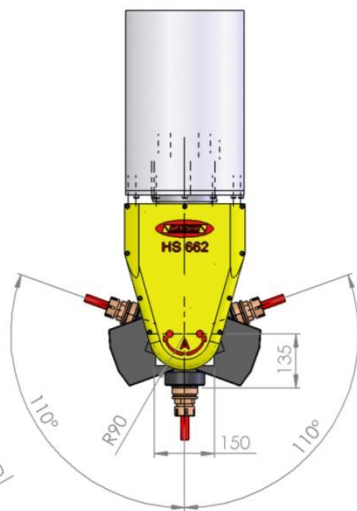
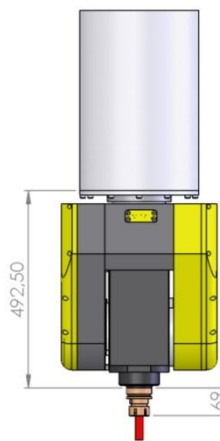
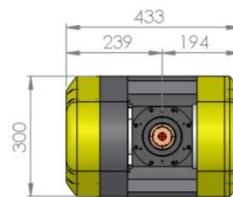
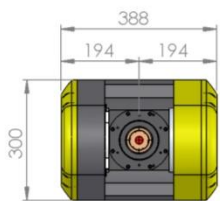

Dimensions of HS662 without direct measuring

Dimensions of HS662 with direct measuring

## Types of Working Desks

The machine can be fitted with several types of working desks or with flexible sliding consoles for vacuum clamping of the work piece. Every type is determined for different way of clamping of the work piece. In the following table are examples of suitable ways of clamping depending on the type of machined material.

Type of Working Desk	Examples
Working table made from hardened KARTIT with screwed holes to hold special tool kit, net of holes M 10 – 100 x 100 mm	Machining of wood, plastics, composites, polystyrene etc.
Cast-iron working table with T slots	Machining of wood, plastics and Al alloys (Al models and forms)
Working table made from hardened KARTIT with integrated vacuum distribution to fix suction equipment or special form patterns, with screwed holes to hold special tool kit - net of holes M 8 in 50mmx50mm raster	Surface machining of wood, plastics, composites (production of staircases, furniture parts, cutting of form parts from surface materials – possibility of vacuum clamping of the work piece)
Sliding consoles SCHMALZ with integrated 2 chamber vacuum distribution and clamping system with suction equipment	Vacuum clamping of the work piece – surface machining of wood (furniture parts, production of staircases)

## Working Desk from Hardened KARTIT

The universal working desk from hardened KARTIT, provided with the fastening threads M10 in the 100x100 mm grid, is used for the machining of wooden models. For gripping universal clamps are mainly used. For gripping of polystyrene it is possible to use two-sided sticky tape.

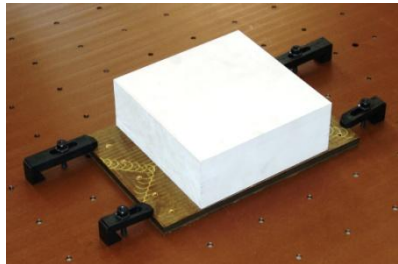

## Cast Iron Working Desk

The universal work table made from grey cast iron with T grooves for normalized T female screws, is also suited especially for the machining of wooden models, but it makes possible quick and exact tightening of different clamping devices, machine clamps, dicing machines, swivelling table etc. After core-drilling, the cast is annealed and then finalized. Thus flatness, accuracy and long-term form stability are achieved.

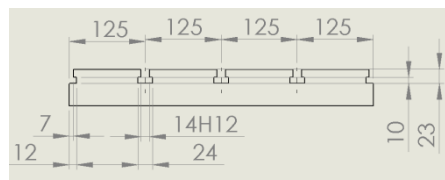

## Vacuum Working Desk from KARTIT

The vacuum working desk with air-operated endstops can be applied everywhere where cutting of board material, which can be fastened to vacuum holders or shape templates, prevails.

The working desk with integrated vacuum distribution system, square raster for vacuum clamps, and fastening threads M8 for tightening of special clamps offer the user a possibility of easy and quick solution for tightening of each work piece.

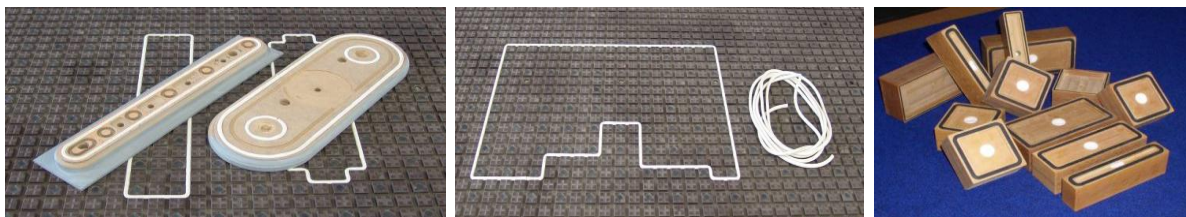



## Sliding Consoles SCHMALZ

Sliding consoles are applied mainly for the machining of slab materials. It is possible to slide all the consoles long ways on a precise ball-line with pneumatic arrestment in the required place. Each console is equipped with massive pneumatic-controlled sticking place. For easy manipulation with heavy materials the outer consoles are shouldered with subsidiary plinth.

It is possible to order sucking disks in 2 heights (50 and 100 mm).

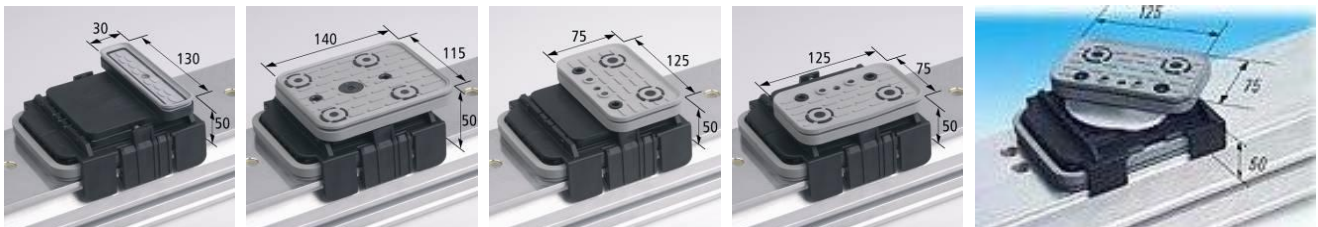
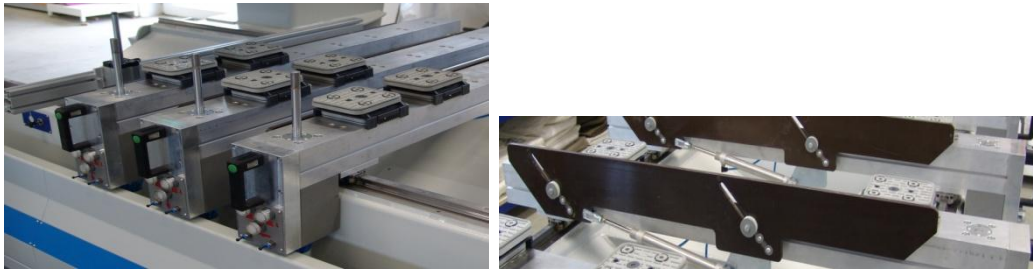

## Tool Changer

Exchange of tools can be realized in two ways. Manual tool exchange is suitable for production, where the instruments vary only in longer intervals (machining of wooden models and polystyrene). Automatic exchange is appropriate in all the other cases. The tool changer includes a TOOL MANAGER Software option embedded in the control system.

Technical Parameters		ATC 12	ATC 44
Type of automatic tool changer		Rotating disk-type	Chain-type with helping hand
Number of positions		12	44
Max. diameter of tool	mm	190	200
Max. weight of tool	kg	5	5
Max. weight of all tools	kg	30	130
Exchange time	s	10	7
Exchange time (chips-chips method)	s	18	14

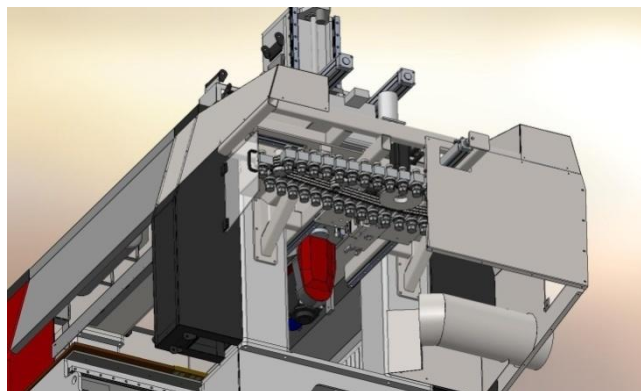
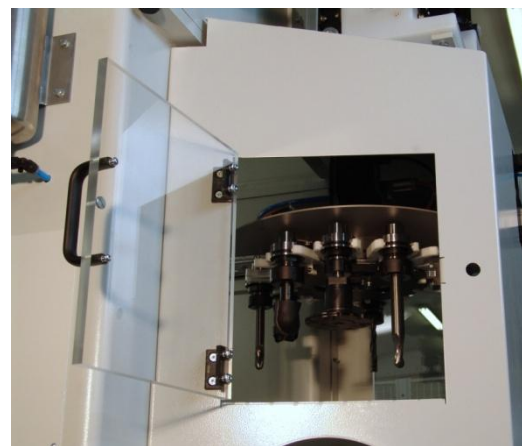

## Control System

The machine is installed with HEIDENHAIN iTNC530 control system by default. When asked for, it can be supplied with the SIEMENS SINUMERIK 840D SL control system. The choice of the system depends on the qualification of the machine operators and their usual practice.

Detailed information on particular control systems can be found on their websites [www.heidenhain.com](http://www.heidenhain.com) and [www.siemens.com](http://www.siemens.com).

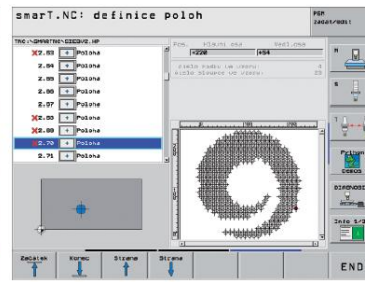
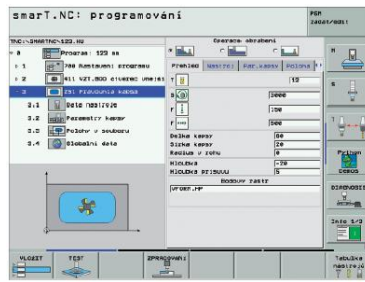

# SIEMENS



## Technical Parameters

Technical parameters DYNAMIC					
Name		FC3000CNC	FC4000CNC	FC5000CNC	FC6000CNC
Working space dimensions	mm	3000 x 1500	4000 x 1500	5000 x 1500	6000 x 1500
Max. speed in X/Y/Z	m/min	40/30/30	40/30/30	40/30/30	40/30/30
Working space of the machine LxW	mm	5650x3320	6700x3320	7740x3320	8780x3320
Weight of the machine	kg	7500	8500	9500	10500

Technical parameters DYNAMIC MAX					
Name		FC3000CNC	FC4000CNC	FC5000CNC	FC6000CNC
Working space dimensions	mm	3000 x 2220	4000 x 2220	5000 x 2220	6000 x 2220
Max. speed in X/Y/Z	m/min	40/25/25	40/25/25	40/25/25	40/25/25
Working space of the machine LxW	mm	5650x4060	6700x4060	7740x4060	8780x4060
Weight of the machine	kg	8800	9800	10800	11800

Technical parameters DYNAMIC SUPER MAX					
Name		FC3000CNC	FC4000CNC	FC5000CNC	FC6000CNC
Working space dimensions	mm	3000 x 2700	4000 x 2700	5000 x 2700	6000 x 2700
Max. speed in X/Y/Z	m/min	40/25/25	40/25/25	40/25/25	40/25/25
Working space of the machine LxW	mm	5650x4520	6700x4520	7740x4520	8780x4520
Weight of the machine	kg	10500	11500	12500	13500

Additional technical parameters		
Connector protection	A	40 - 50
Voltage	V	400
Conductor connecting profile	mm <sup>2</sup>	6 - 10
Frequency	Hz	50 / 60
Compressed-air connector	MPa	0,6 – 1,0
Diameter of the air connector		1/4"
Compressed-air consumption	l/min	250
Connecting diameter of exhaust	mm	300

## Accuracy of the Machine

The machine can be manufactured in a version with linear measuring system (for precise productions such as machining of aluminium alloys, production of patterns and moulds) or in a version without it (cutting of plastics, composites, serial production of furniture parts, etc.). The choice depends on the precision requirements for the production.

Accuracy of machine		Indirect measurement	Direct measurement
Repeatability in X/Y/Z (one way)	mm	±0,03	±0,01
Repeatability in X/Y/Z (two ways)	mm	±0,06	±0,015
Repeatability in A/C (one way)	"	30	5
Repeatability in A/C (two ways)	"	50	5
Distance travelled X/Y/Z (deviation from 1000 mm)	mm	±0,15	±0,02
Distance travelled A/C (deviation from 90°)	"	25	5
Acceleration X/Y/Z	m/s <sup>2</sup>	3	3
Acceleration A/C	°/s <sup>2</sup>	300	300

Direct measurement of the company SCHNEEBERGER is integrated directly in the ball-rail system. Laser burnt marks along the rail line are read by a moving scanning head, which is an integral part of the wagons. Special electronics then processes the signal and transmits it to the control system.

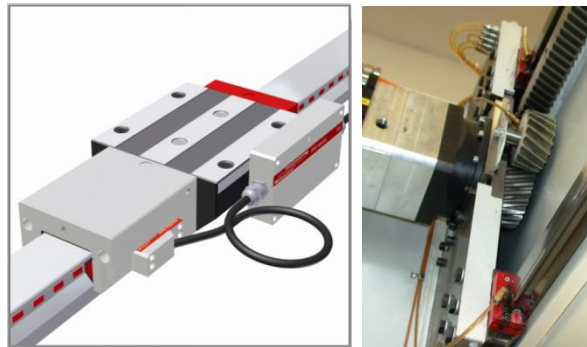

Direct measurement of the rotating axes is fitted with optical scanners HEIDENHAIN. The scanners are placed directly on the exit shafts. This ensures high accuracy and constancy.



## Probes, Measurement and Positioning

The machine can be supplied with tool (measuring the tool length, diameter, radius) and alignment probe (measurement and the establishment of the work piece). Measuring functions depend on the type of the control system. The probes support users and help to reduce idle times. The probes have many pre-arranged cycles for automatic adjustment of the clamping of the work piece, for the setting of the referencing point and of the zero point, for the measurement of instruments and also for the final measurement of the machined part.

- The work piece misalignment is compensated by the rotation of the coordinate system of the machine
- For the work piece pre-setting, you can use a reference point to assign a defined value to any work piece position, for example on the corner of a work piece, in the middle of a circle or an arch etc.

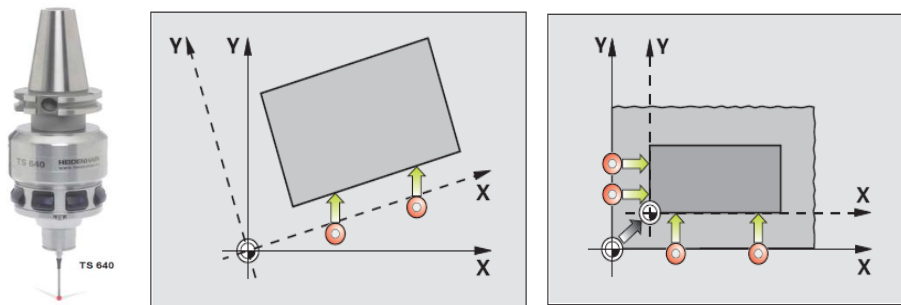

### Tool adjustment:

The TT 140 tool touch probe captures the tool length directly in the machine's workspace. The tool touch probe is inserted directly into the machine tool spindle, simply by the means of a screw M8. The tools can be measured while standing or rotating.



## INDEXERS – Additional Rotating Axis “A”

The machine can be fitted with additional NC axis for the machining of complex rotating parts. Spindle of the indexers can be fitted with a universal chuck for the clamping of the work pieces. Tailstock with a rotating tip is used for the supporting of long work pieces. The spindle has a special backlash-free gearbox with preloaded face plate placed in needle and acicular bearings. This is to ensure highly accurate positioning without the side clearances and high stiffness required for productive machining.

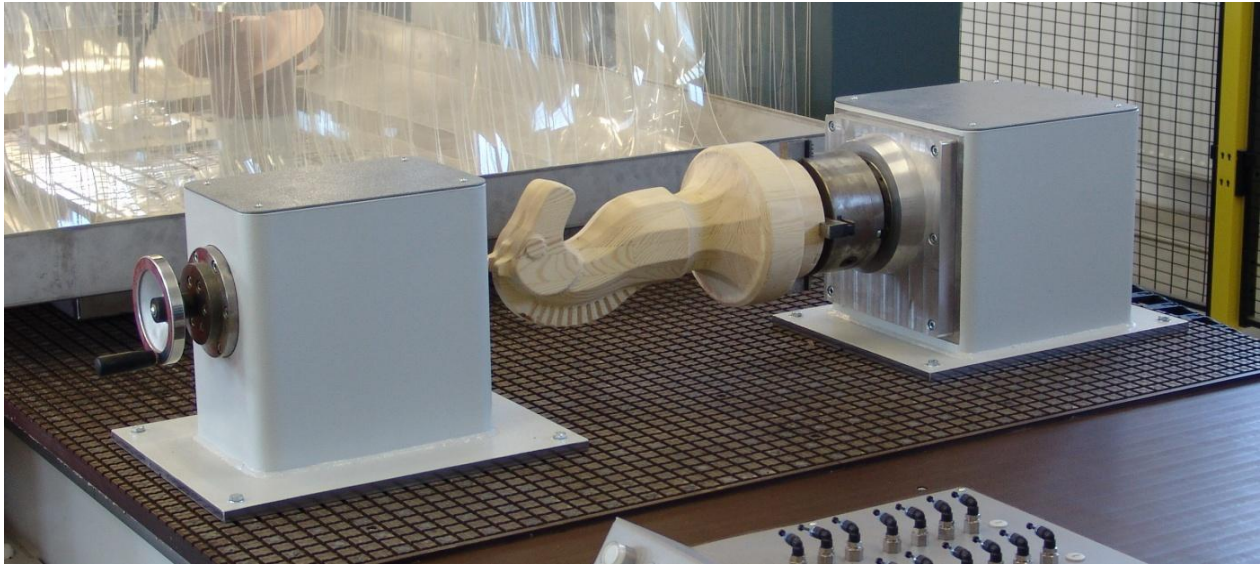

Maximal clearance of work piece	°	400
Working stroke	°	±99999
Maximal speed	°/min	5000
Chuck diameter	mm	160
Clamping cone in tailstock sleeve	MK	3

## Drilling Unit VDA21

**Drilling unit VDA 21** is sliding drilling aggregate placed beside the main spindle. VDA21 enables productive drilling of particular holes into the work piece or parallel drilling of several holes at once, in a 32mm distance. It is used for the production of furniture parts, staircases etc.

Layout:

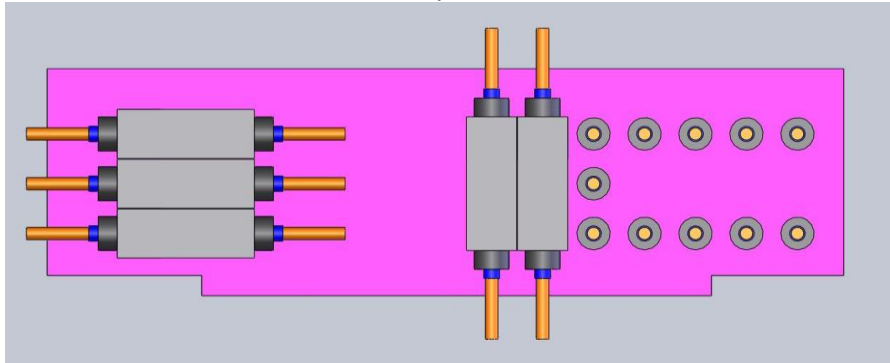

VDA 21		
Number of vertical drills	pcs	11
Number of vertical drills in X	pcs	2 x 5
Number of vertical drills in Y	pcs	3
Number of double-sided horizontal drills in X	pcs	3
Number of double-sided horizontal drills in Y	pcs	2
Working revolutions	rpm	4000
Clamping collet	mm	10
Maximal diameter of a drill	mm	30

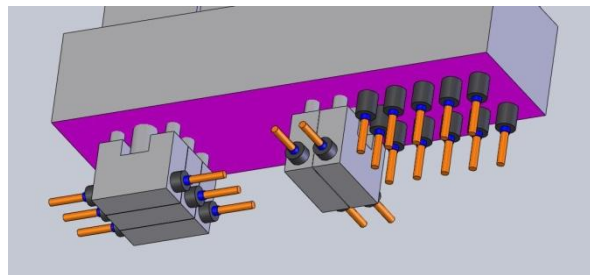
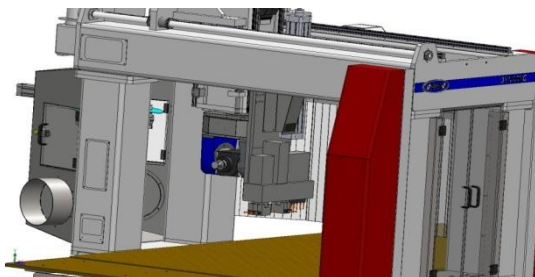



## Machining of Polystyrene

For productive machining of polystyrene a special adapter for clamping of the tools with integrated suction is used.

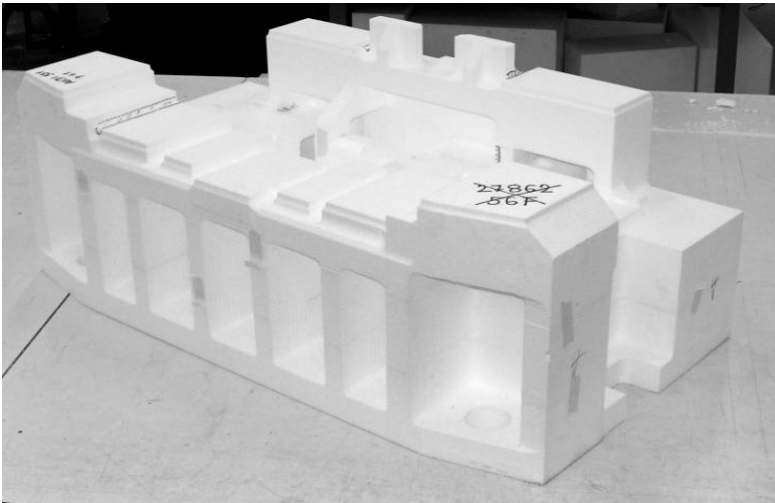

## Machining of Al Alloys

For productive machining of aluminium alloys and some types of plastics, it is necessary to cool and grease the tool during the machining. To meet this requirement, an oil aerosol (fog) aggregate is used.



Tool cooling with the help of oil fog is a modern method especially suitable for the machining of aluminium alloys. Rape-seed oil is used as refrigerant. Lubricating unit is spraying coolant in the form of a very fine oil fog using compressed air. The oil fog is fed through nozzles directly to the cut. Despite a very small consumption of the coolant, this method is very effective. The consumption of the refrigerant is about 4 litres per year in an 8-hour work shift. Cooling unit is located directly on the machine spindle.

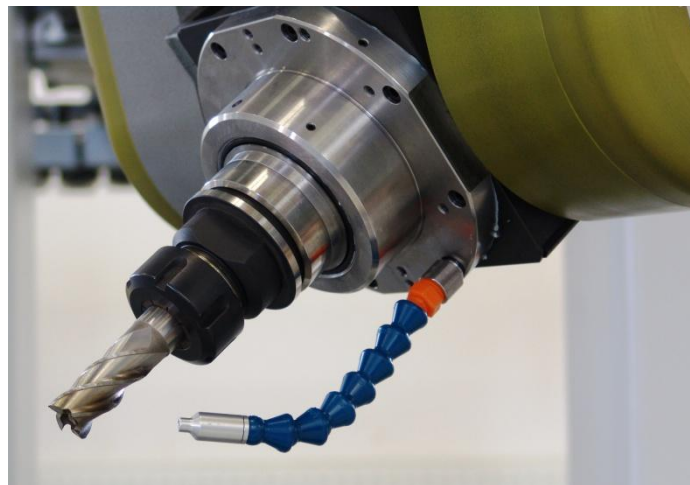

## Machining of Composites AIR EXHAUST TURBINE (AET)

For the machining of composites, it is possible to fit the machine that includes the HS662 Head with integrated AET suction directly from the point of incision. In order to ensure effectiveness of the suction in the point of incision, the suction power is amplified by an axial turbine, which has enough suction capacity for the suction of splinters directly from the point of incision. The end piece of the suction nose pipe has to be adjusted to the length and diameter of the tool. On the following picture the suction principle is shown:

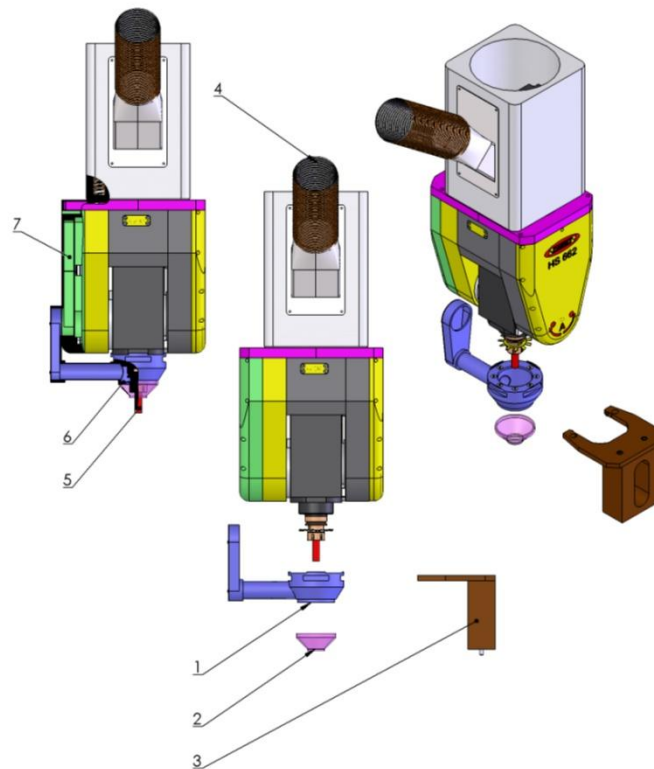

1	Suction nose pipe
2	End piece
3	Discharge fork
4	Suction connection
5	Tool
6	Auxiliary turbine
7	Side cover with integrated canal for the drain off of the splinters

The opening for the connecting hose has a diameter of 125 mm. The suction aggregate should have a suction capacity of about 1500 m<sup>3</sup>/hour and a minimum suction pressure of 1500 Pa. The suction aggregate has to comply with the requirements for suction of the dust from composite materials.

## Foundry Patterns





## Automobile Industry

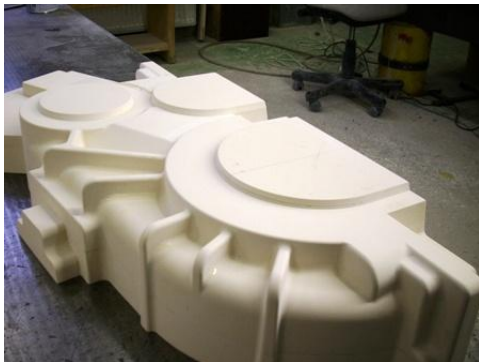
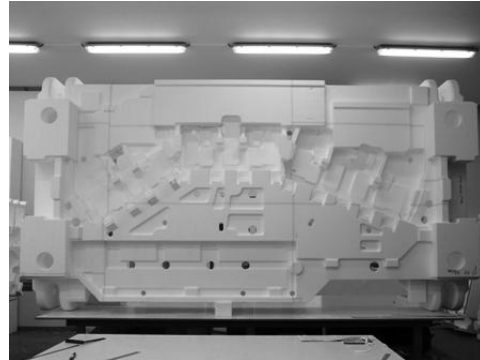

## Aerospace Industry

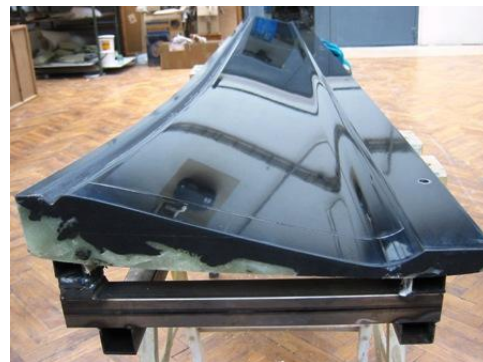
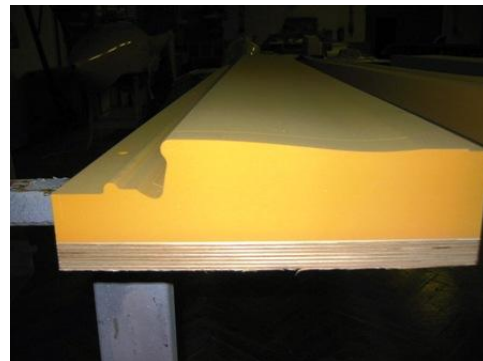

## Machining of Plastics and Composites

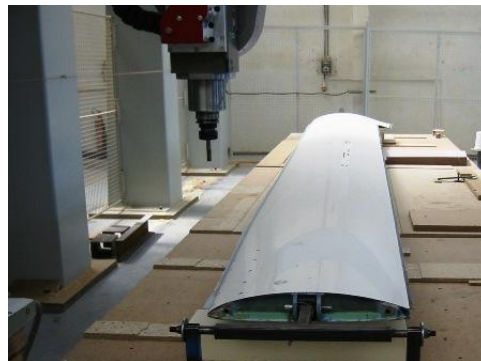



## Wooden Components



## Contact

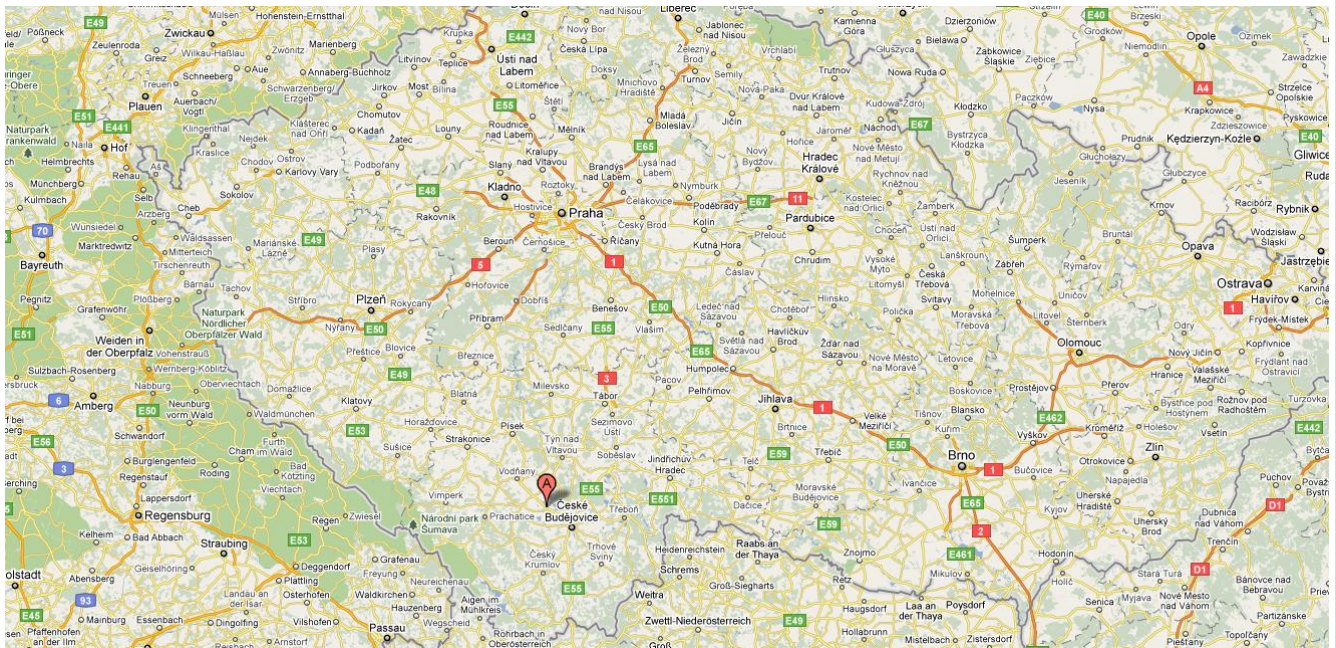
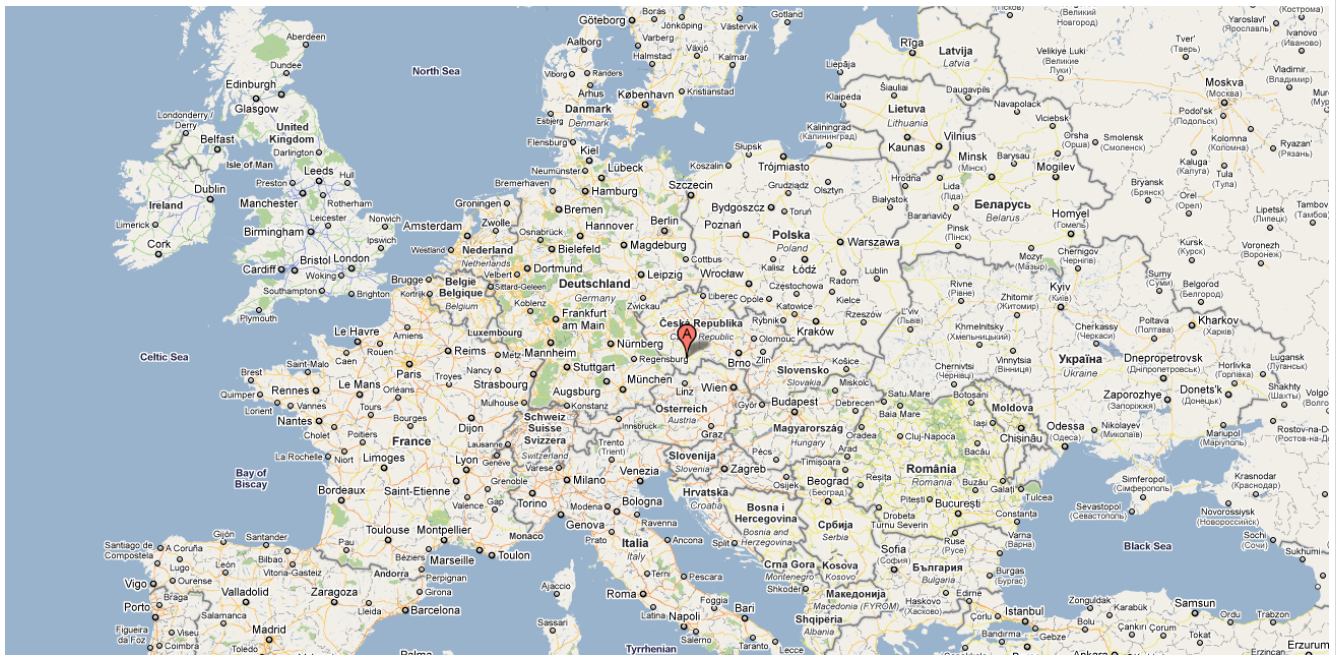

**SAHOS s.r.o.**  
**Pistín 134**  
**37341 Hluboká nad Vltavou**  
**Czech Republic**

**Phone/Fax: +420 387 203 126**

**Phone: +420 382 526 392**

**e-mail: [sahos@sahos.cz](mailto:sahos@sahos.cz)**

**URL: [www.sahos.cz](http://www.sahos.cz)**