

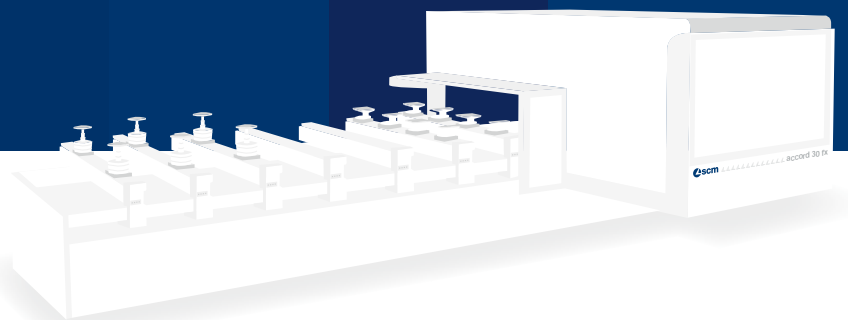

# accord 30 fx

CNC machining centre



# accord 30 fx

CNC machining centre

New-generation modular machining centre designed for machining operations involving heavy duty stock removal with high precision and top quality finish. Ideal for making door and window frames, doors, stairs and solid wood elements in general.

- **TOTAL FREEDOM OF USE**  
powerful, reliable machining heads with 5 interpolating axes made for any use, even the most heavy duty.
- **MAXIMUM PRODUCTIVITY AND SAFETY**  
the machine is always used at its maximum production capacity without limits on movement and in total safety.
- **TOP QUALITY FINISH**  
Machining with maximum precision on the entire machining area, thanks to the rigid mobile portal structure.

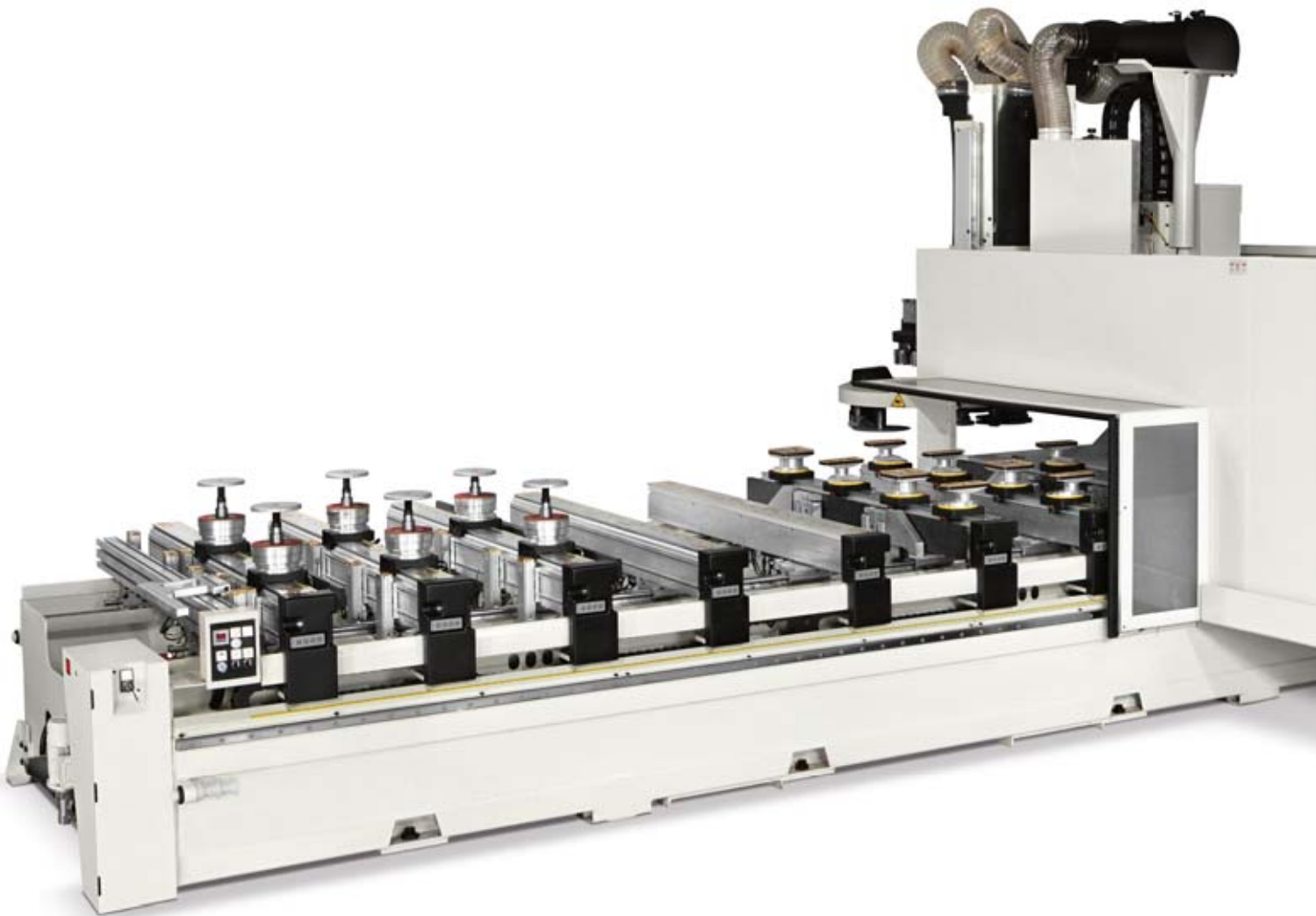



-  cutting.
-  planing.
-  **routing.**
-  sanding.

# accord 30 fx

technological advantages



## **MOBILE PORTAL STRUCTURE TOTAL ABSENCE OF VIBRATIONS!**

designed for maximum precision even in the presence of large machining areas, guaranteeing lasting stability.



## **MACHINING HEADS WITH TWIN INDEPENDENT Z AXIS**

allowing fast alternating of the units present during machining and when possible tool changes in masked time.



## **MACHINING HEADS CAN BE CONFIGURED FOR DIFFERENT PRODUCTION REQUIREMENTS**

Accord 30 fx allows all types of machining to be performed, from power routing with 5 interpolating axes to high-capacity boring and the machining of door and window frames with the exclusive "BRC" unit.



# accord 30 fx

machining head:  
main routing unit



Compact and powerful, the Prisma head can use any type of tools, even large tools for intensive machining operations typical for door and window frames.

A whole range of machining heads with 3 to 5 interpolating axes able to carry out all machining operations required of a machining centre.

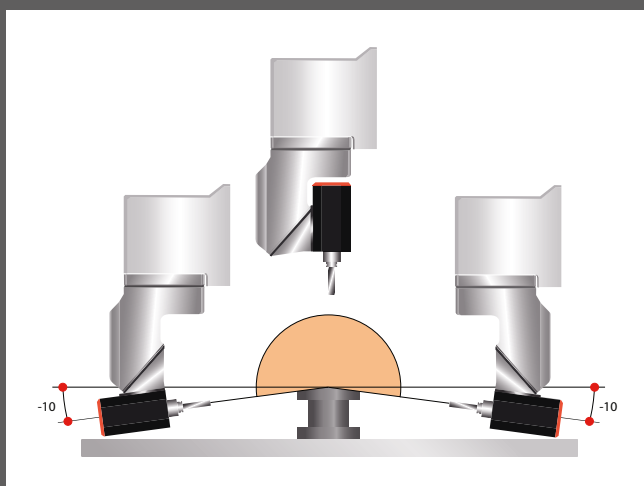

Prisma allows machining up to 10 degrees below the horizontal axis.



Clean working environment with the conveyor helping to eliminate shavings and sawdust. Available for heads with 3 or 5 axes, it can be used both with single-profile tools and double-profile tools.

**machining head:**  
BRC multi-function unit

Cutting, routing and boring both vertically and horizontally, without needing the tool changer, using the BRC unit. Fast and precise for all accessory machining, for making a door or window frame there is a single secondary unit using an independent Z axis and dedicated inverter.



# accord 30 fx

machining head:  
auxiliary unit for boring and routing

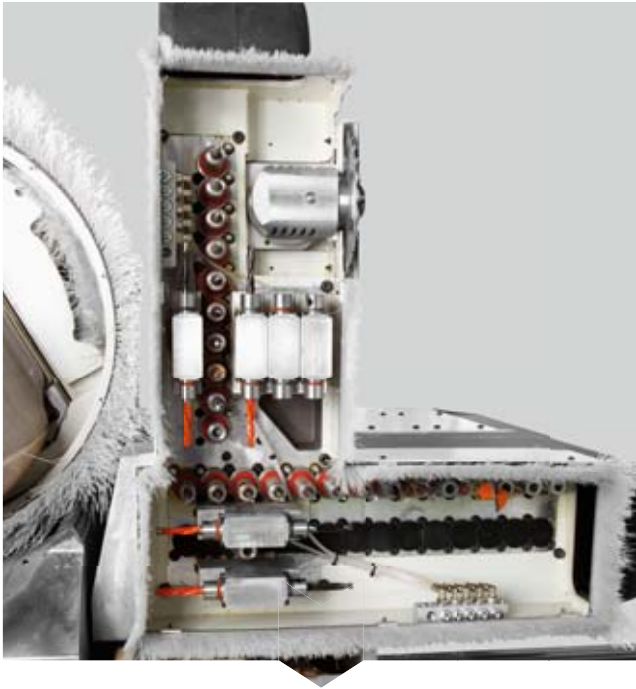

The optimum solution to all boring requirements is found in the wide range of modules available for the Accord fx, with from 14 to 50 independent spindles.

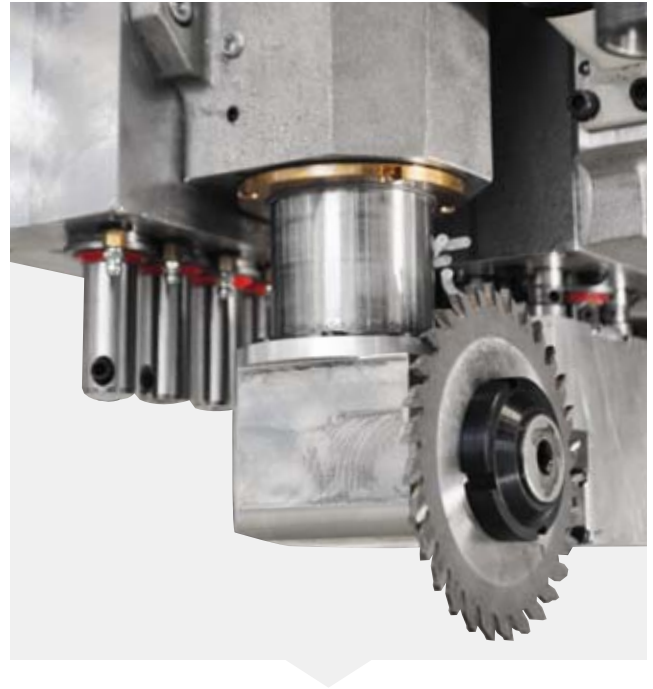

Longitudinal and transversal cuts can be made with the blade unit built into the boring head with 0-90° rotation.

Faster operation, more tools available with the PB TC additional routing unit, power 8.5 kW and a 6-location Rapid tool changer.





tool magazines



The machine is always equipped for any machining using the TRC chain magazine with 48 locations available for large and double-profile tools.



Accord fx has solutions suitable for any production, such as the Rapid 12 on-board even allowing tool changes in masked time, which can be combined with additional magazines such as the Rapid 16 or 24.

To have the most tools available, the rack magazine may have up to 12 locations, using the items present on the machining head.

# accord 30 fx

MATIC worktable

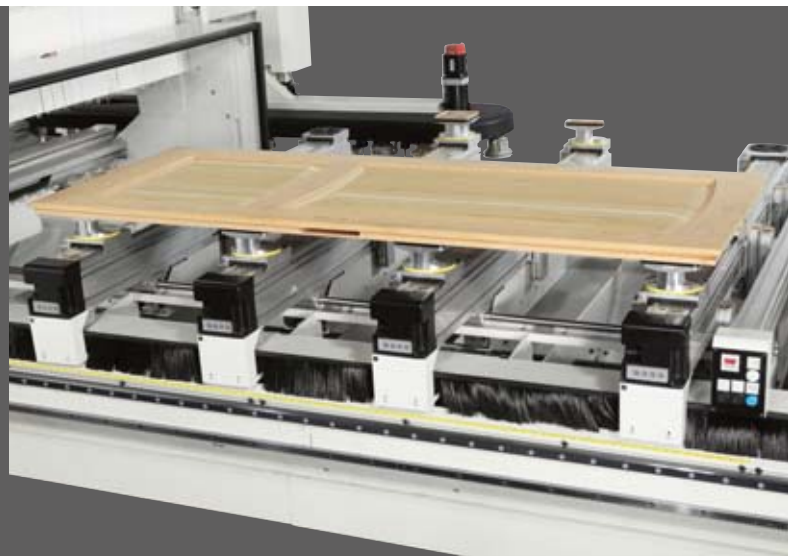

Matic is the fully automatic worktable ideal for machining solid wood. Complete set-up in seconds, all bars and supports moving simultaneously, each driven by an independent motor. The many technical devices give this table lasting safety and reliability.



Switching from clamps to suction cups and vice versa is fast and practical. The quick coupling perfected by SCM allows operators to switch at the press of a button, without the need for external tools.



Perfect for machining pre-finished/finished door and window frames, all supports having cleaning blowers which remove all shavings from the sliding zone and on the workpiece hold-down base during clamp changes.

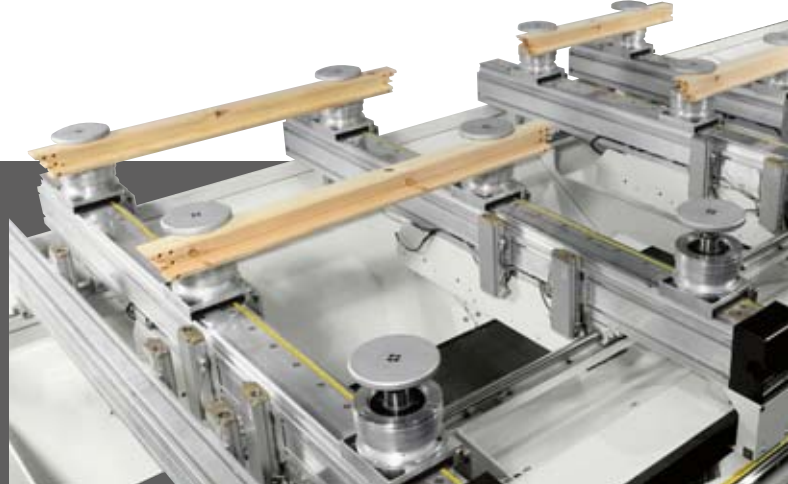
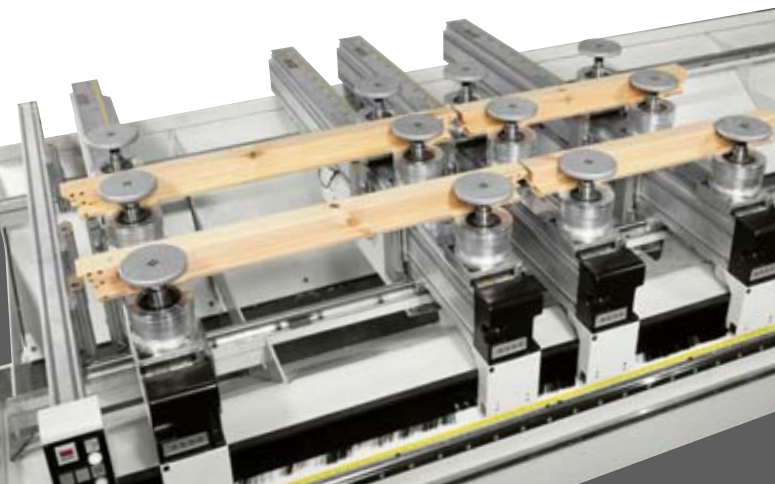

Workpiece loading and unloading is easy and ergonomic. They are automatically carried to the machining zone to prevent any kind of collision thanks to total worktable management.

# accord 30 fx

worktable with manual and guided movement



The worktable with manual movement is available in the "Start" and "Pilot" versions, allowing maximum freedom of use thanks to the quick coupling system for adding and removing clamps and suction cups to always guarantee optimum hold-down.



In the "Pilot" version positioning is guided and controlled by the workpiece program. Magnetic sensors detect the correct position of all components, eliminating the risk of collision.



Fast operations that do not require any further checks; the display on the mobile console shows the position for each element and provides a real-time view of all movements until the correct position is reached.

The worktable can be configured for machining heights of 50 mm or 110 mm with a range of clamps and suction cups for holding down and fixturing workpieces having any shape.

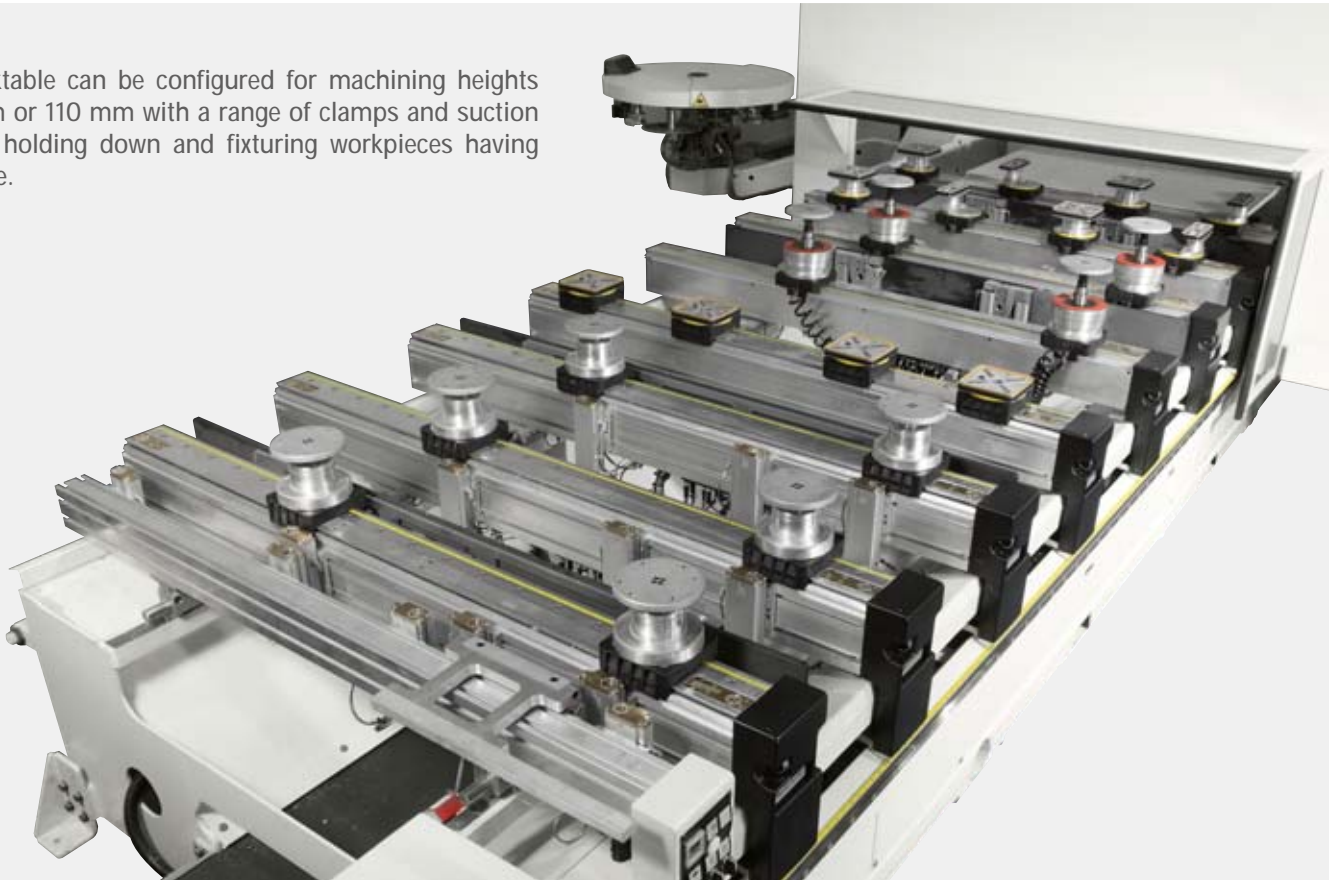

All versions of SCM worktables use common accessories and always offer ideal hold-down to provide top quality finishing even with heavy duty stock removal.

The H110 worktable allows maximum freedom of movement with tools and even use of "double-profile" tools.

# accord 30 fx

worktables

The exclusive SCM multi-function worktable allows the use of a whole range of accessories designed to meet all workpiece support and hold-down requirements. The MPS system is extremely practical to use.

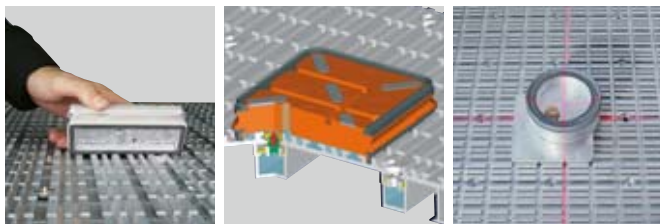

Fixturing operations are practical and easy. The exclusive aluminium profile has grooves and holes specially designed for optimum positioning of any type of support. This work is even faster using the laser pointer which shows the precise point where the suction cups must be placed.

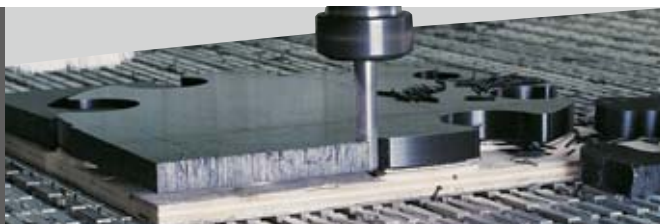

The directly machined worktable guarantees lasting absolute precision and perfect flatness thanks to its high level of rigidity. Also ideal for machining plastics, resins and light alloys.



## safety systems "Pro Speed" and "Pro Space"

Accord 30 fx allows you to select the safety system most suitable for the customer's requirements, in terms of available space and production methods. The systems have no floor sensor, which means the

machine offers 100% loading access without any obstacles, and the possibility to exploit the entire length of the table for pendular machining operations; the utmost freedom of movement in absolute safety.

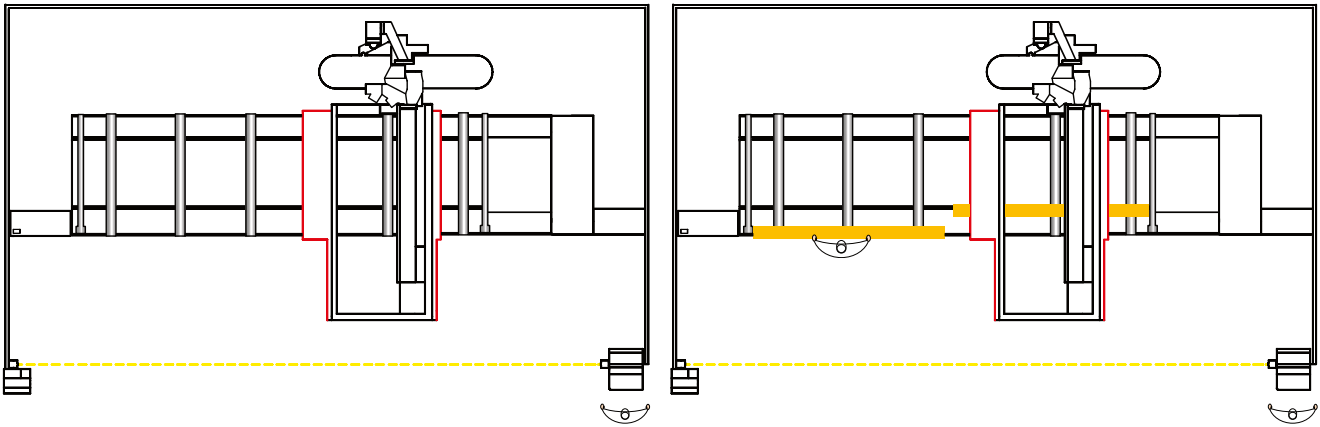

"Pro Speed" safety system: the loading area is marked off by a photocell that informs the control system of any possible operator access; the sensors on the mobile portal will only stop the machine in the event of contact. The machine can be used at its top feed speed (90m/min.) when the operator is outside the loading area.

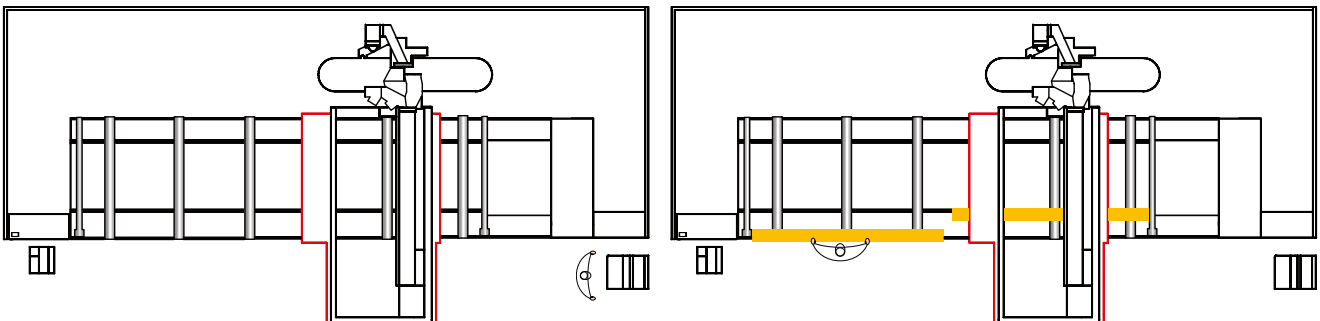

"Pro Space" safety system: the loading area is completely free, to minimise the space occupied from front to back; the sensors on the mobile portal will only stop the machine in the event of contact. The machine can be used at a feed speed of 25m/min.

# accord 30 fx

xilog maestro **software**:  
the Scm group new CAD/CAM, powerful and user-friendly.

## **XILOG MAESTRO** power and simplicity.

Xilog Maestro is the new powerful programming software dedicated to **SCM** machining centres.

Developed in the Windows® environment, it includes all the features and performance that allow easy, intuitive and effective programming even for people unfamiliar with Personal Computers or those using a machining centre for the first time.

- 3D graphics editor for workpiece, geometries, machining and worktables
- CAD mode geometries drawing functions
- Programming machining operations on angled faces
- Import DXF files: all formats with layer and geometries recognition
- Import Xilog Plus XXL and PGM files
- Macro writing via editor or scripting
- Additional software modules (optional) for door and window frames
- Production times calculation
- Teleservice



The technical data can vary according to the requested machine composition. In this catalogue, machines are shown with options. The company reserves the right to modify technical specifications without prior notice; the modifications do not influence the safety foreseen by the CE Norms

SINERT





CNC machining centre		ACCORD 30 FX
<b>Axes</b>		
X-Y axes speed	m/min	90
Workpiece passage	mm	250
<b>Electro-spindle</b>		
3- and 4-axis electro-spindles power	kW	8,5 - 12 - 13
Max. rotation	RpM	24.000
5-axis electro-spindles power	kW	11
Max. rotation	RpM	24.000
On-board tool magazine	n° pos.	12
Rear tool magazine	n° pos.	16 - 24 - 48
Lateral tool magazine	n° pos.	8 - 10 - 12
<b>BRC</b>		
Power	kW	3
Max. rotation	RpM	18.000
<b>3-axis additional electro-spindle</b>		
Power	kW	8,5
On-board tool magazine	n° pos.	6
<b>Boring head</b>		
Spindles	n°	da 14 a 50
Power	kW	3
Rotation	RpM	2000 - 8000
<b>Installation</b>		
Suction opening diameter	mm	1 x 100 - 1 x 250
Suction air speed	m/sec	25
Suction air consumption	m <sup>3</sup> /hr	1300 / 4400
Compressed air consumption	NL/min	170 - 300
Machine weight	Kg	6000 - 9000

BARS TABLE	
machining area X	machining area Y
3050	1380
3680	1380
5020	1380
6360	1380
3680	1680
5020	1680
6360	1680
3680	1905
5020	1905
6360	1905

MULTI-FUNCTION TABLE	
machining area X	machining area Y
3050	1320
3650	1320
4970	1320
6170	1320
3650	1600
4970	1600
6170	1600
3650	1840
4970	1840
6170	1840
3650	2120
4970	2120
6170	2120

- 
-  **scm**
  -  **minimax**
  -  **scm tecmatic**
  -  **scm**
  -  **routech**
  -  **celaschi**
  -  **dmc**
  -  **superfici**
  -  **sergiani**
  -  **gabbiani**
  -  **morbidelli**
  -  **mahros**
  -  **stefani**
  -  **cpc**
  -  **sag**
  -  **scmgroup**  
engineering
  -  **delmac**  
engineering
  -  **scmfonderie**
  -  **steelmec**
  -  **hiteco**
  -  **es**
  -  **csr**
  -  **CMS Cms**  
wood technology
  -  **CMS Cms**  
advanced materials technology
  -  **CMS Brembana**  
stone technology
  -  **CMS Brembana**  
glass technology
  -  **CMS CmsPlast**  
plastic technology
  -  **CMS Tecnocut**  
waterjet technology
  -  **CMS Balestrini**

| **1**  
large integrated  
group  
/

| **18**  
production sites  
/

| **30**  
specialist  
brands  
/

| **21**  
foreign branches  
/

| more than **50**  
years in business  
/

| **70%**  
exports  
/

| **350**  
agents and  
distributors  
/

| **365**  
registered patents  
/

| **500**  
engineers  
/

| **3.000**  
square metres  
showroom  
/

| **10.000**  
classical and  
professional  
machines made  
per year  
/

| **240.000**  
square metres  
of production  
space  
/



[www.scmgroup.com](http://www.scmgroup.com)

passion**technology**performance

**scm**  **group**



SCM GROUP SPA SCM - Via Casale, 450 - 47826 Villa Verucchio, Rimini - Italy  
tel. +39 0541 674111 - fax. +39 0541 674235 - housing@scmgroup.com - www.scmgroup.com



00L0076377B