

CNC-Processing Center

Venture 2.5

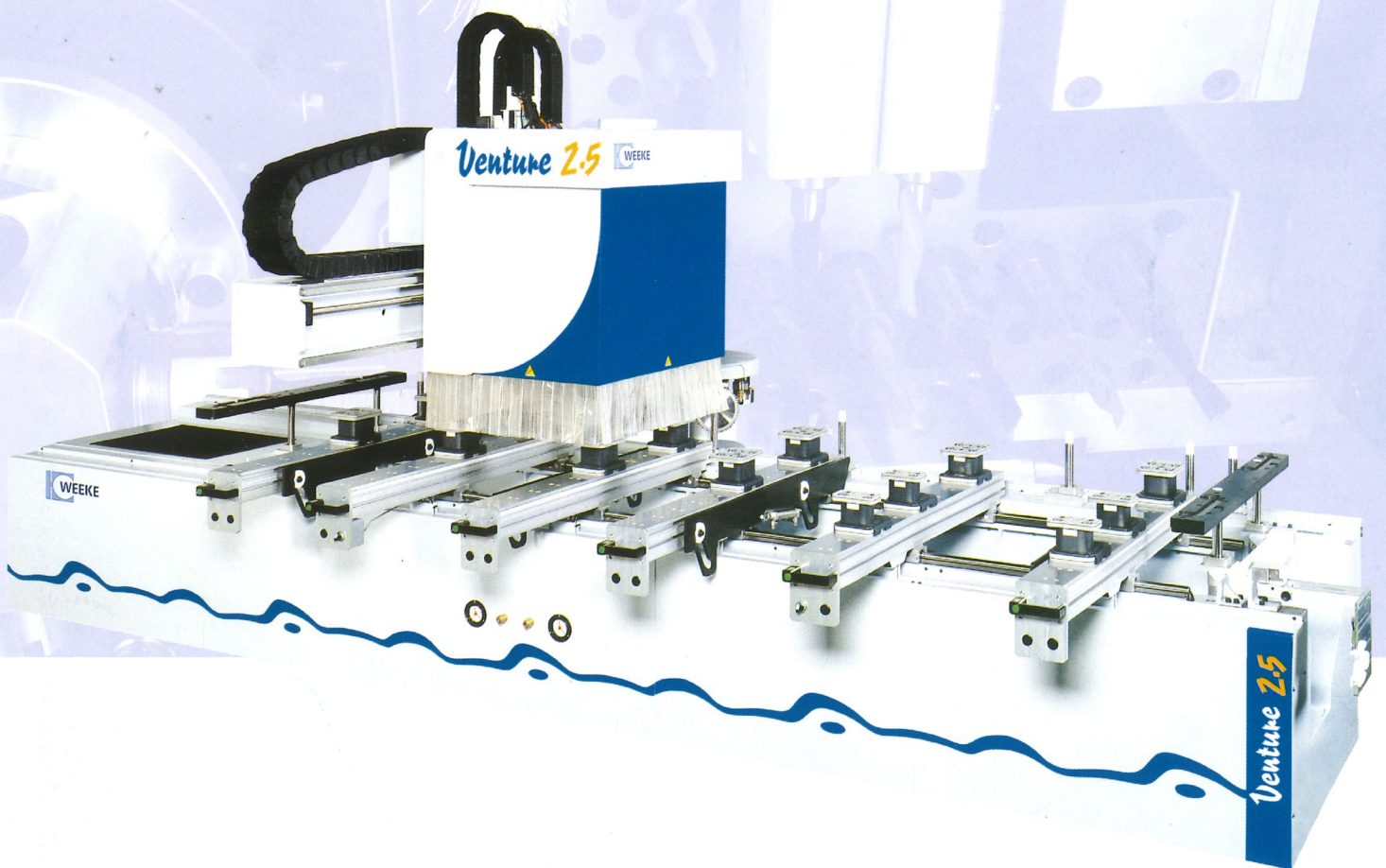

2005

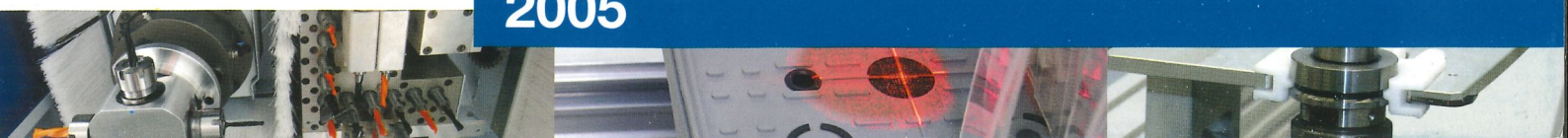

Venture 2.5

Working field:
3250 x 1250 x 100 mm

Highlights:

- An integrated C-Axis
- Even under heaviest processing the heavy steel ribs within the frame absorb any resonance and frame flexing.
- A powerful 7.5 kW HSK routing spindle
- 2 Z-axes
- Routing dimension in Y-direction to max. 1378 mm
- 8 tool changing places
- A flexible clamping system with the Weeke K-Table
- Simple pneumatical fixing of the consoles
- Secure positioning of the vacuum cups via laser positioning
- UPS „uninterrupted power supply“ - protects the computer against damages in case of mains interruption. In such a case the computer is powered down to avoid loss of data.

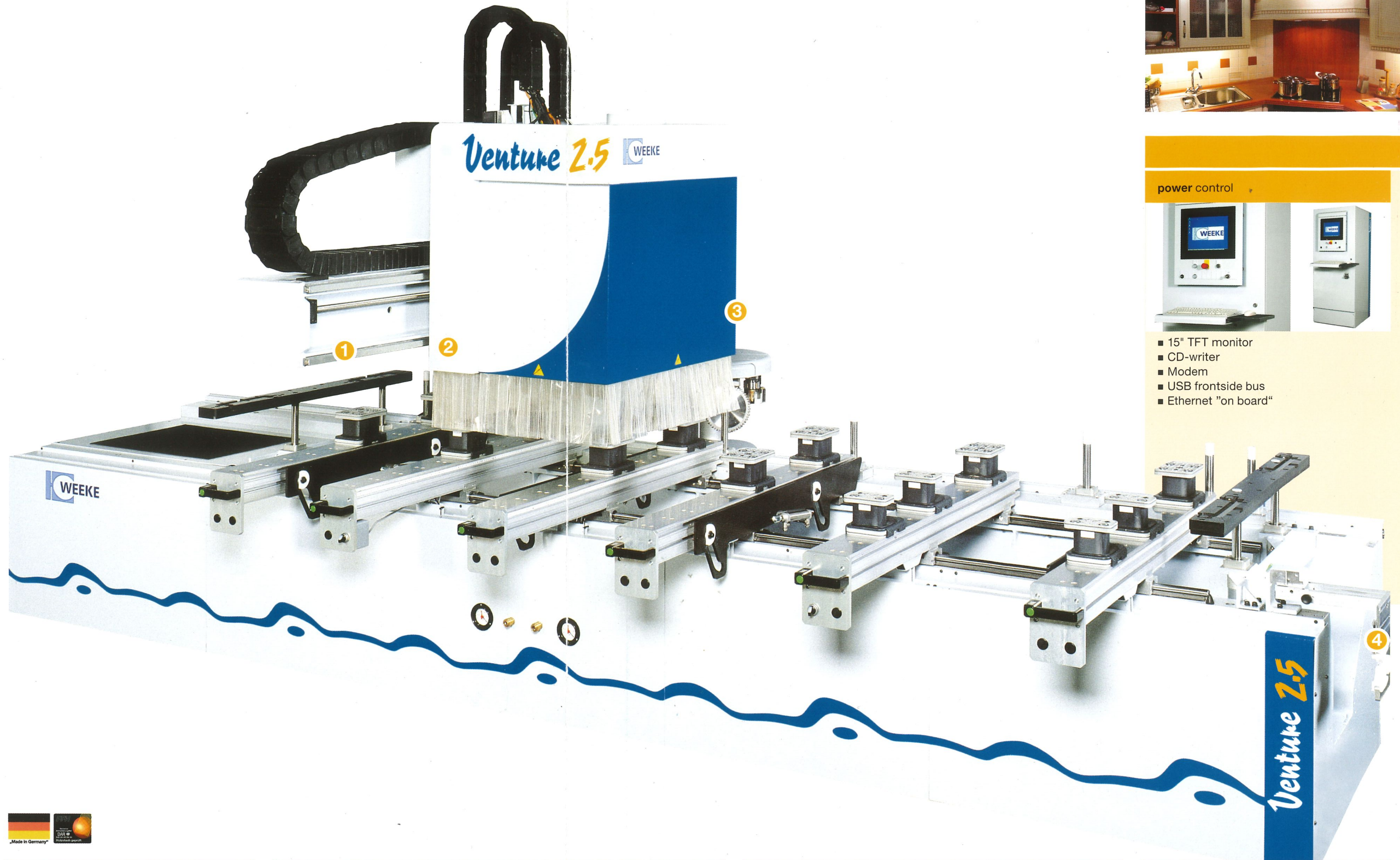

power control



- 15" TFT monitor
- CD-writer
- Modem
- USB frontside bus
- Ethernet "on board"



1 Linear guiding system



Sealed "long-life" linear guiding system

2 Laser positioning

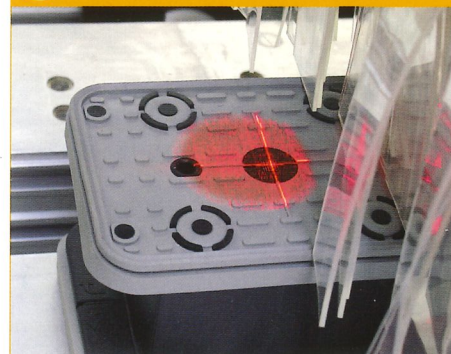

Simple positioning of the vacuum cups through the pin laser

2 Z-axes



Offer an optimal dust extraction and a bigger operative range for processing tools

3 Configuration

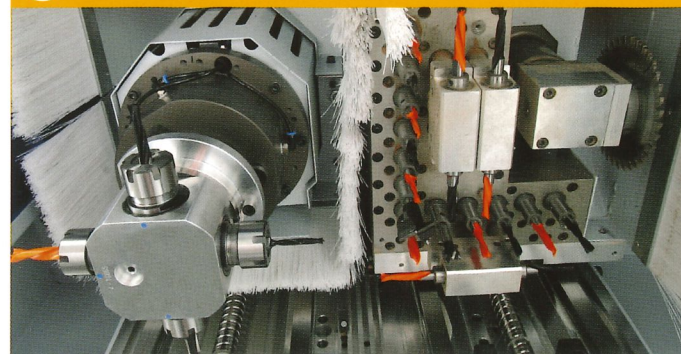

■ 12 vertical drilling spindles ■ 6 horizontal drilling spindles ■ 1 routing spindle with 7.5 kW ■ 1 grooving saw (Ø 125 mm / 90°) ■ C-axis

4 Tool pick-up station

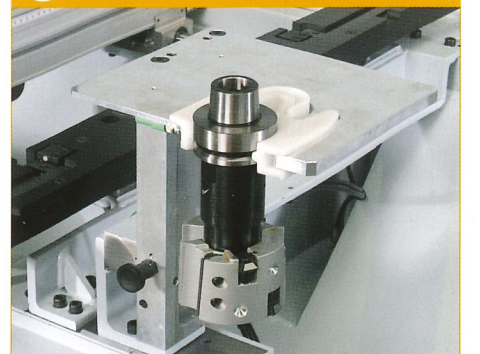

Secure fitting of the tool changer

Pictures may also show options



All inclusive – "Standards"

High-Speed spindles

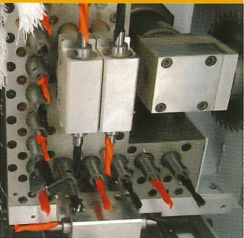

1500 - 7500 RPM

Automatic spindle locking system

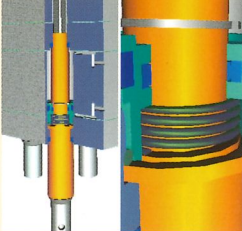

Exact drilling depth at any time with different materials

Workpiece feeding rail

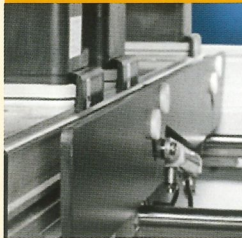

4 solid feeding rails for easy feeding of heavy workpieces

UPS

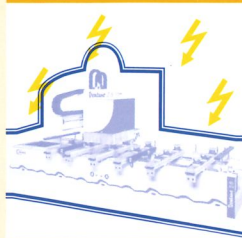

Protects the computer against damages in case of mains interruption

Tool changer

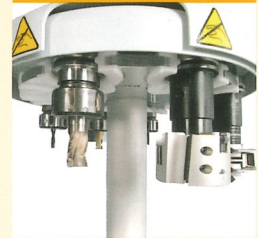

Fast 8-fold tool changer in X- and Y-direction

Vacuum cups

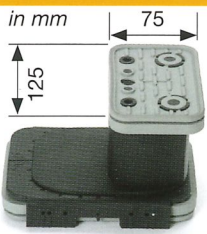

4 narrow vacuum cups

Vacuum cups

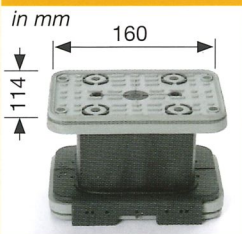

10 standard vacuum cups

C-axis

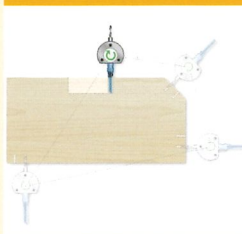

0 -360°

Sealed energy cable



Secure and protected cable guide (X-Y-Z)

Tool kit



Top equipment - from the very start

Software

woodWOP

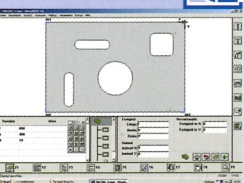

- Modern software based on Windows®
- More than 10.000 installations worldwide

woodDesign

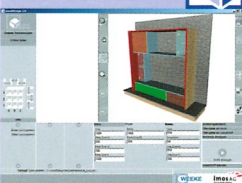

- Simple 3D construction of furniture including a parts list output and export of cutting lists

3D CNC-Simulator

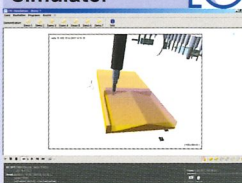

- Simulates the processing in the order it is stored in the NC-program
- Allows time calculation
- Collision check of the vacuum cups

MCC

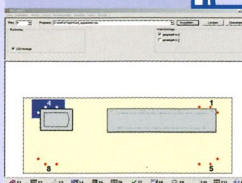

- Modern and simple control of main machine functions through soft keys
- Graphical loading
- Optimized space

MDR

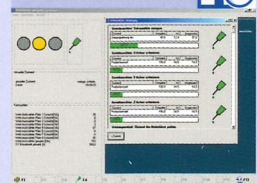

- Machine Data Recording - collecting and evaluating machine states via time meter and event meter

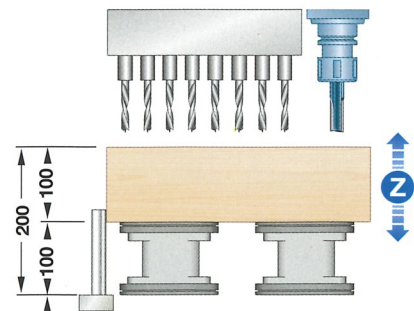
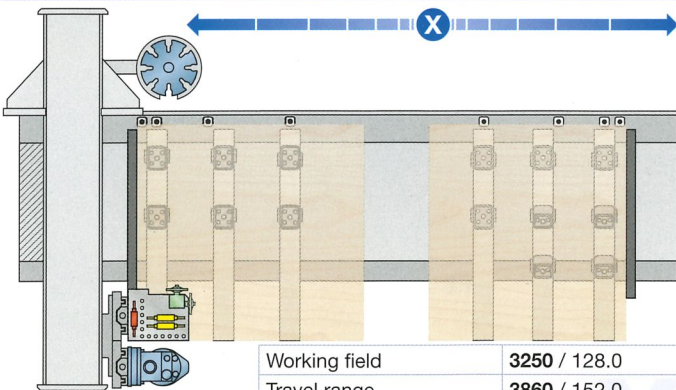

Working field	3250 / 128.0	1250 / 49.2	100 / 3.9
Travel range	3860 / 152.0	1793 / 70.6	185* / 7.3 (300** / 11.8)
Routing	3595 / 141.5	1378 / 54.3	100 / 3.9
Alternating operation	1450 / 57.0		
Two-field operation	1100 / 43.3	mm / inch	

*drilling | **routing

Venture 2.5

Options

Air-conditioning

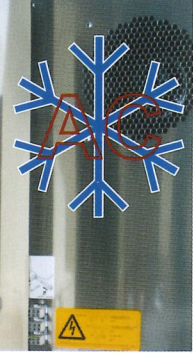

Air-conditioned cabinet

Multi-clamping system

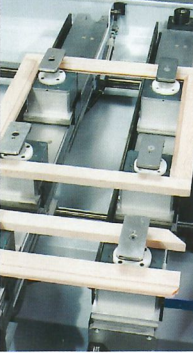

E.g. for frame and narrow parts

Tilting stops for laminate overhang

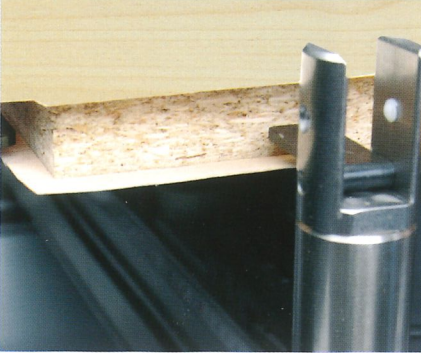

Guarantee simple positioning of panels with laminate overhang

Software

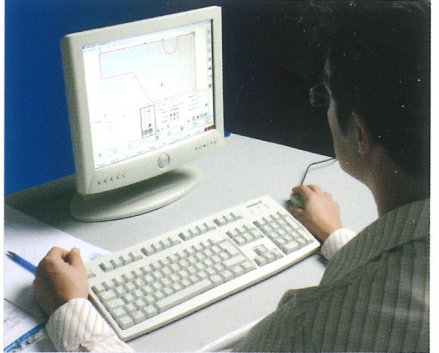

■ DXF-postprocessor ■ Barcode software

Adapter aggregates

Drilling/Routing/ Sawing, 2 spindles



1603

Routing, 2 spindles

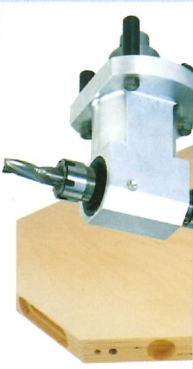

1610

Routing, 4 spindles

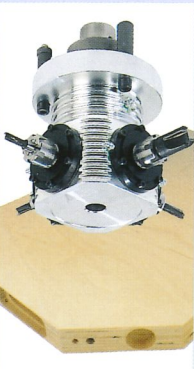

1605

Drilling/Routing, man. inclinable – (0° - 45°)

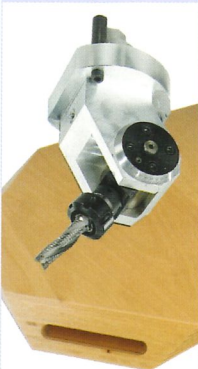

1613

Cam box router, Ø 16 mm, 2 spindles

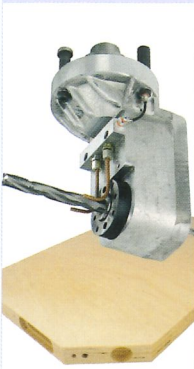

1626

Routing vertical with tracing bell



1650

Corner notching

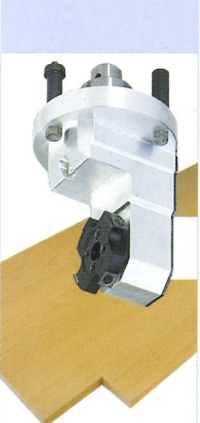

1656

Drilling, 7 spindles – 25 mm pitch



1680

Fitting drilling head, 3 spindles

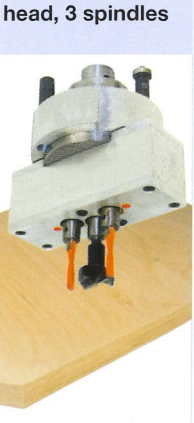

1695

Contact us - WORLDWIDE



- Teleservice possibility via basic-modem-connection
- Competent spare parts service
- Weeke communication: up-to-date information at all times:
www.weeke.com
- Any questions, new ideas, criticism & praise to:
info@weeke.de

Venture 2.5

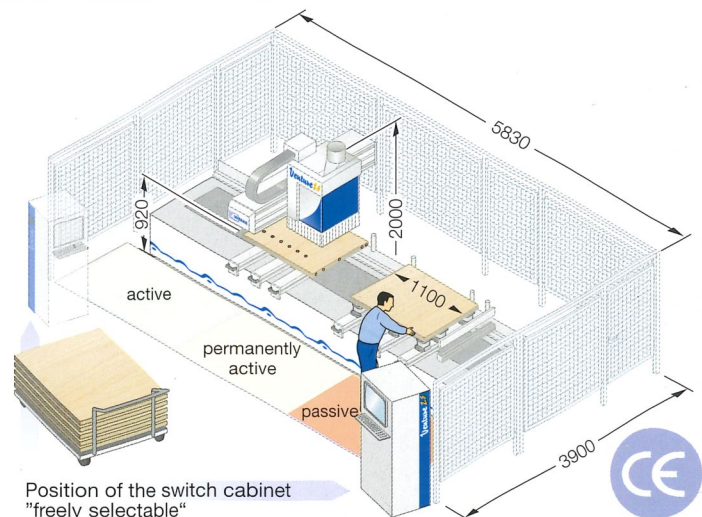
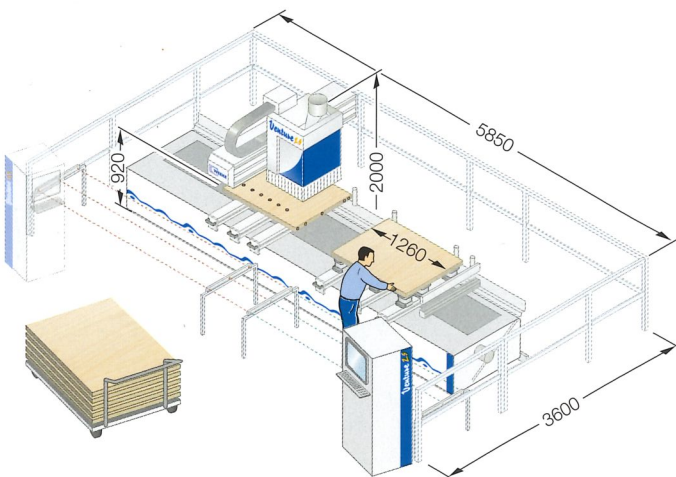
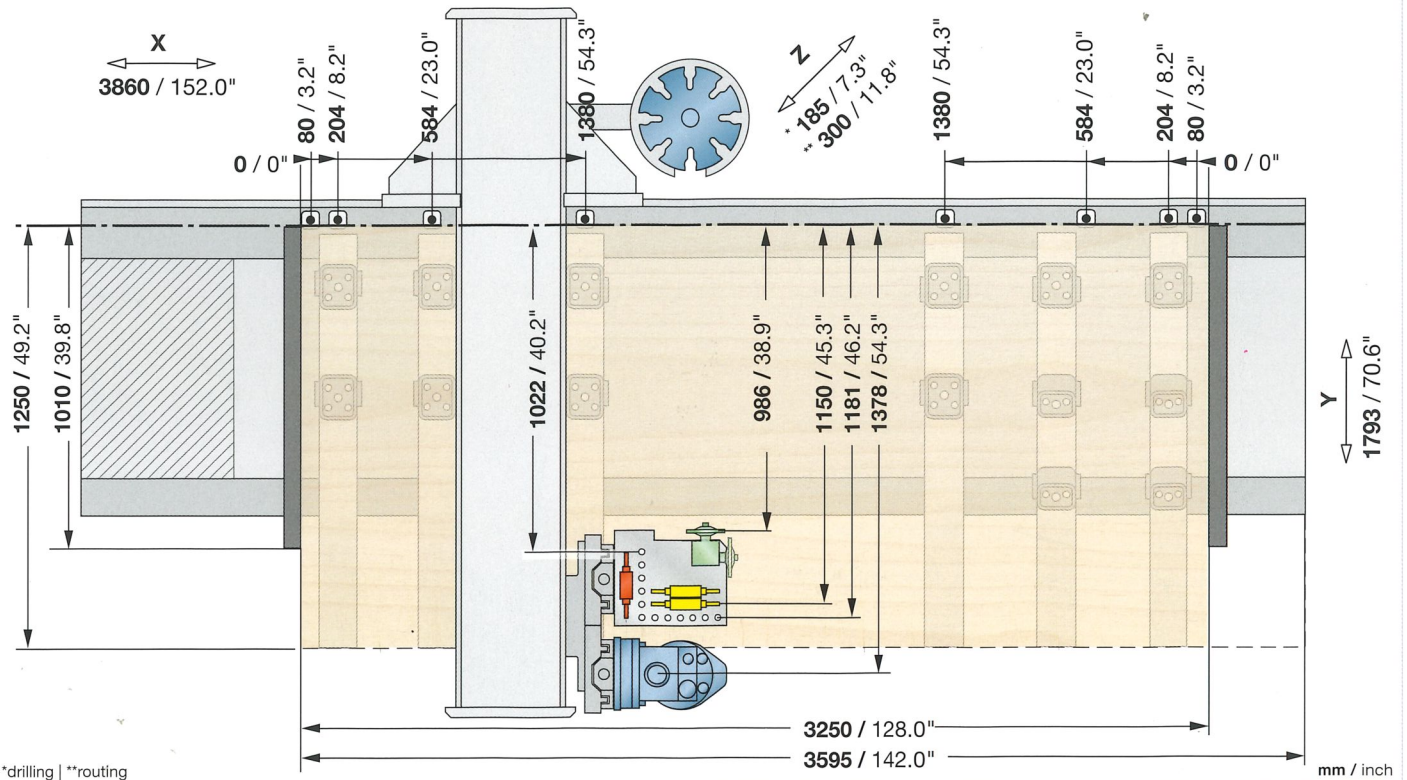

TECHNICAL DATA

Travel range X - Y - Z-axis	mm	3860 - 1793 - 185*/300**
Rapid traverse speed X - Y - Z-axis	m/min	60 - 50 - 15
Compressed air connection	Zoll	R 1/2"
Compressed air required	bar	7 bar
Dust extraction port	mm	Ø 200
Dust extraction volume	m³/h	min. 3170
Total machine weight	kg	ca. 4300
Electrical power - total connection load	kW	16
Switch cabinet L - W - H	mm	800 - 800 - 1970



WEEKE Bohrsysteme GmbH

Benzstraße 10-16
 33442 HERZEBROCK-CLARHOLZ
 Germany
 Phone: +49 5245 445-0
 Fax: +49 5245 445-139
 info@weeke.de - www.weeke.com