

# PRODUCT CATALOGUE 2019

SÜMA BÜG-MASCHINEN | PRODUCT CATALOGUE 2019 | ENGLISH



**SÜMA**  
BGU MASCHINEN



## Your reliable partner for firewood machines, logging technologies and metalworking machines.

With a 40-year experience in machinery production, the brand SÜMA BGU-Maschinen stands for high-quality equipment „Made in Germany“ and demanding applications.

We guarantee robust and reliable machines in a special design, designed for long-lasting use and offer our customers a good price-performance ratio. We are a certified company with a very wide dealer network serving more than 18 European countries. At SÜMA the new company image is customer satisfaction and customer loyalty which are ensured by specialist staff and personal contact

We work in a growth-oriented manner and constantly expand or improve our scope of services and the quality of our products and services.

Our extensive range of forestry / firewood processing machines are characterized by safety according to CE, technical reliability and optimal functionality. With our know-how in research and development, we are constantly working to live up to this claim in the future.

Our sales motto will remain “convincing through performance” in the future as well. We need no grandstanding statements or superlative headings. A trial test and a practical demonstrations will do. Do not hesitate. Ask our closest dealer in your area for a quality and performance demo. Alternatively, ask for them for more specifications and information on operation and lifetime. You will be amazed.



# Contents

## **Saw**

Cross-cutting beam saws	04 - 07
Accessories for saws	08
Accessories for sawmills	09

## **Log splitter**

Vertical short log splitters	10 - 11
Horizontal short log splitters	12 - 13
Vertical longwood splitters	14 - 17
Horizontal longwood splitters	18 - 19
Log splitter accessories	20 - 21

## **Saw & splitter combination**

Saw & splitter combination	22 - 23
Automatic chainsaw processor	24 - 29
Accessories saw splitting technique	30 - 31

## **Garden shredder**

Garden shredders	32 - 35
------------------	---------

## **Extraction technology**

Conveyor belts	36
Transfer Rack	37

## **Bagging systems**

Firewood bundling systems	38 - 39
Accessories for bagging systems	40 - 41

## **Timber grapples technologies**

Timber grapples technologies	42 - 47
Grapple attachments	48 - 51

## **Metalworking**

Metal band grinder	52 - 53
Press drill	54 - 55
Metal bandsaw	56 - 57

## **General information**

General Sales Conditions	58 - 59
--------------------------	---------

## Cross-cut saws

- KS 600 (230 V)
- KS 600 (400 V)



*The machine has a professional two-hands control: one hand holds the log retainer down, whilst the other operates the saw. This removes nearly any risk of pinched hand dangers.*

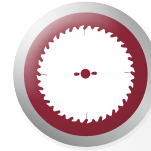

**STANDARD  
WIDIA BLADE**

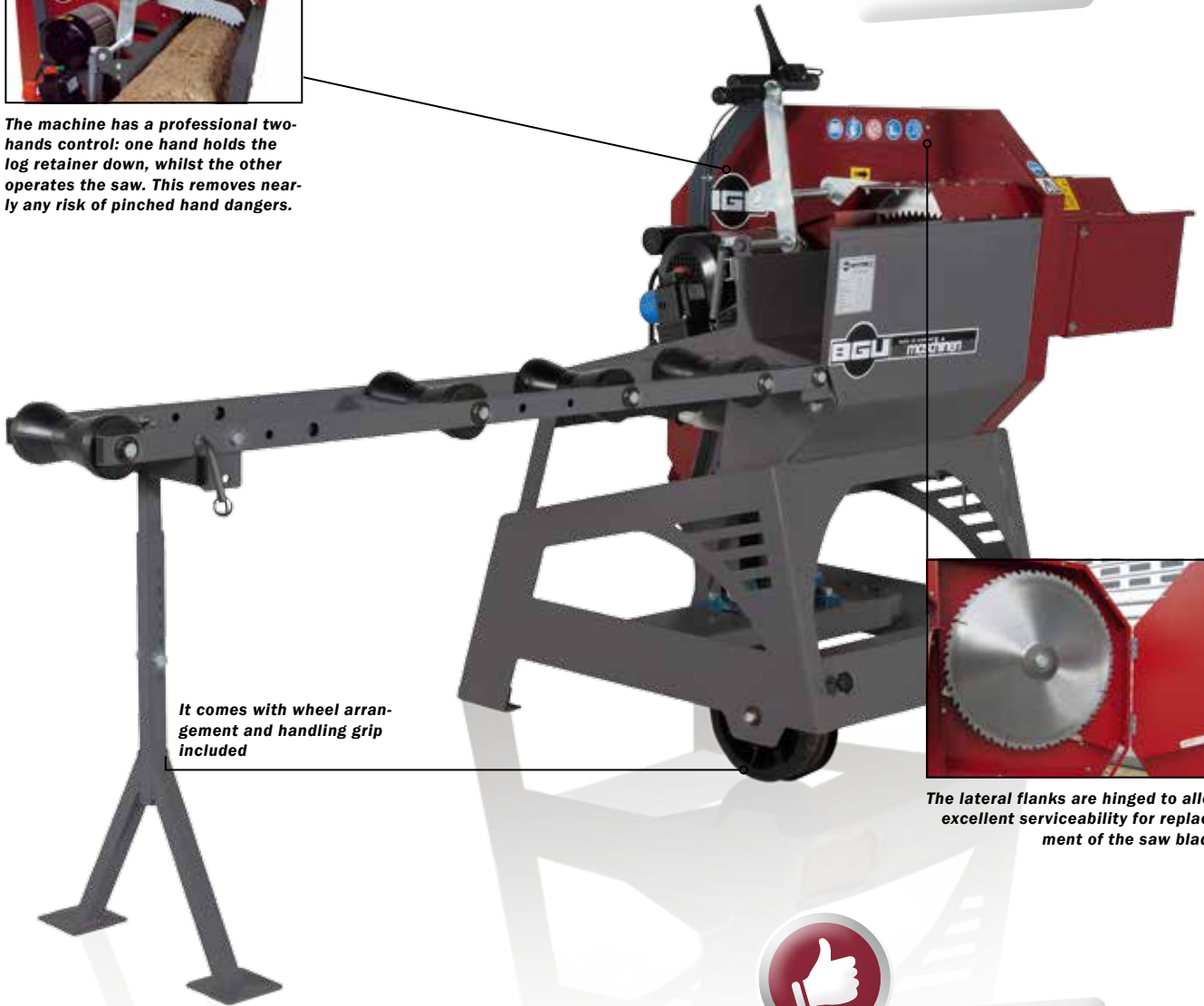

*It comes with wheel arrangement and handling grip included*



*The lateral flanks are hinged to allow excellent serviceability for replacement of the saw blade.*



**More accessories  
on page 8**

## Modern technologies

**This cross-cutting saw merges top operation comfort and user-friendly handling.**

This particular circular cross-cutting saw is the highlight of SÜMA BGU Maschinen firewood saws. Featuring all advantages of a rugged steel frame, this machine offers the additional benefit of a very long life and excellent endurance. It is equipped with a special motor with built-in electronic blade brakes that eliminates dangerous coast-to-stop times of rotating machines and equipment. The operating concept is outright opposite to the one of traditional log cutting saws. In this case, in fact, it is the saw blade that moves to approach the log and not vice versa. This allows very short and effortless cutting cycles.

- Low-energy motors on all electric models (less power consumption at higher output power)
- All electric models have an electric engine with safety thermal overload switch.
- Equipped with standard Widia saw blade, graduated ruler (to control the log length), and log retainer.
- An infeed roller table can be attached to the machine on request (Code No. 90197)



**A special flexible guard on the saw arbor ensures top safety in all cutting positions. The blade teeth are always covered.**



**No more tilting of the carriage to the blade is needed. So, the log that is cut off the saw drops straight down into the hopper of the downstream belt conveyor.**



**The entire cross-cutting mechanism is a user-friendly construction, very easy to operate thanks to two oversized roller bearings. This makes the entire operation system exceptionally effortless.**

### Cross-cut saws

Technical Data	KS 600 (230 V)	KS 600 (400 V)
Power / motor	Electric, 230 V	Electric, 400 V
Rated power	3,0 kW P <sub>1</sub> S6 40% ED	4,0 kW P <sub>1</sub> S6 40% ED
Saw blade speed	1280 Rpm	1380 Rpm
Cutting capacity	approx. 200 mm (7.9 in)	approx. 200 mm (7.9 in)
Blade diameter Ø	600/30 mm (23.6/1.2 in)	600/30 mm (23.6/1.2 in)
Dimensions (W x L x H)	1020 x 1000 x 1300 mm	1200 x 900 x 1600 mm
Weight	approx. 138 kg (304.2 lb)	approx. 155 kg (341.7 lb)
<b>Code No.</b>	<b>90192</b>	<b>90193</b>

## Cross-cut saws

- KS 700 E
- KS 700 Z
- KS 700 H



**STANDARD  
WIDIA BLADE**



*The lateral flank is hinged to allow excellent serviceability for replacement of the saw blade.*

*Equipped with a standard graduated ruler (to control the log length in price).*

Saws



*High quality paint, powder coating, scratch-proof and weather resistant*



**More accessories  
on page 8**



No more tilting of the carriage to the blade. So, the log that is cut off the saw drops straight down into the hopper of the downstream belt conveyor.



Model 700 Z with shaft-mounted gear pump (built-in hydraulics).



The entire cross-cutting mechanism is a user-friendly construction, very easy to operate thanks to two oversized roller bearings. This makes the entire operation system exceptionally



An hydraulic control valve is provided within operator's quick reach in order to switch the cutting blade on and off as needed.



Professional two-hands control  
Use: One hand holds the log retainer down, whilst the other operates the saw.

## Unique cross-cut saw technology

The cross-cut saw models combine highest comfort with the easiest handling.

- Low-energy motors on all electric models (less power consumption at higher output power)
- All electric models have an electric engine with safety thermal overload switch.
- Equipped with standard Widia saw blade and log retainer.
- All 700 models are equipped with standard graduated ruler (to control the log length), and outlet conveyor included in price.
- An infeed roller table can be attached to the machine on request (Code No. 90198)
- **KS 700 Z:** This machine attaches directly to your tractor hydraulics. The saw blade is powered by the tractor hydraulics via PTO shaft and shaft-mounted gear pump (built-in hydraulics). The normal cutting performance is already available when the PTO shaft rotates at 300 rpm.
- **KS 700 H:** Connected to the tractor hydraulics and attached to the tractor by means of a three-point hitch, the model enables a quick start. (A pressure line and a non-pressurized return line are required.)

### Cross-cut saws

Technical Data	KS 700 E	KS 700 Z	KS 700 H
Power / motor	Electric, 400 V, 16 A EC plug	PTO shaft	hydraulic
Rated power	5,2 kW P <sub>1</sub> S6 40% ED	Traktor approx. 15 kW / 20 PS	Traktor approx. 10 kW / 13,6 PS
Operating pressure			max. 200 bar
Pump capacity	-	approx. 20 l/min (4.4 gal/min)	
Saw blade speed	1380 Rpm	1500 Rpm	1750 Rpm
Cutting capacity	approx. 250 mm (9.8 in)	approx. 250 mm (9.8 in)	approx. 250 mm (9.8 in)
Blade diameter Ø	700/30 mm (27.5/1.2 in)	700/30 mm (27.5/1.2 in)	700/30 mm (27.5/1.2 in)
Dimensions (W x L x H)	1130 x 1000 x 1400 mm	1170 x 1080 x 1400 mm	1170 x 1080 x 1400 mm
Weight	approx. 193 kg (425.5 lb)	approx. 250 kg (551.1 lb)	approx. 194 kg (427.7 lb)
<b>Code No.</b>	<b>90190</b>	<b>90189</b>	<b>90191</b>

## Accessories KS 600

### Roller table for KS 600



Code No.

Roller table attaching to the log carriage for convenient advancing of logs up to 3.5 m (11.5 ft) long, available on request.

**90197**

### Spare roller for roller table KS 600



Code No.

Retrofitting roller table (attached to the existing holes)

**90194**

## Accessories KS 700

### Roller table for KS 700



Code No.

Besonderheit: Rollenbahn kann für den Transport in Sekundenschnelle hochgeklappt werden.

**90198**

### Three-point linkage for KS 700 E



Code No.

Use it for short-distance transportation/ handling of your KS 700 E on the tractor.

**90199**

### Spare roller for roller tableKS 700



Code No.

Retrofitting roller table (attached to the existing holes)

**90194**

## Other accessories circular saws

### Log retainer



Code No.

for retrofitting for models for Spessart Woody 603, Spessart Woody 701, WK 600/B Classic and WK 700 Z Classic

**91272**



Code No.

for retrofitting for models WK 790/2 and ZWK 790/2

**91274**



Code No.

for retrofitting for models WK 780/2, WK 780 RB/2 and ZWK 710/2

**91273**

### Chrome-steel



Code No.

debarking blades, Ø 600 mm (23.6 in), 30 mm (1.2 in) bore



**95271**





## Accessories bandsaw mills

PTO shaft	
	Cat. 1, 1 3/8" w. 6 splines 1 m (3.2 ft) long suitable for all PTO saws and splitters, logging winches up to model FSW 4.5, as well as GSZ 242 Combi.
<b>Code No.</b>	<b>95060</b>

Precision Widia-blade with 30 mm (11.8 in) bore	
	Saw blades Ø 700 mm (27.5 in) with 84 teeth suitable for circular saws are also available.
<b>Code No.</b>	<b>95024</b>

Replacement Chrome-blade with 30 mm bore	
	Ø 600 mm (23.6 in), 36 teeth
<b>Code No.</b>	<b>95004</b>
	Ø 700 mm (27.5 in), 42 teeth
<b>Code No.</b>	<b>95021</b>
	Ø 750 mm (29.5 in), 46 teeth
<b>Code No.</b>	<b>90076</b>

Spare Widia blades with 30 mm bore	
	Ø 600 mm (23.6 in), 56 teeth
<b>Code No.</b>	<b>95002</b>
	Ø 700 mm (27.5 in), 56 teeth
<b>Code No.</b>	<b>95011</b>

Bimetal Saw Band, Type I for BBS 500 (tooth pitch 8.3 mm = 0.32 in)	
	27 x 0,9 x 3110 mm
<b>Code No.</b>	<b>90792</b>

Bimetal Saw Band, Type I for BBS 500 B (tooth pitch 8.3 mm = 0.32 in)	
	27 x 0,9 x 3340 mm
<b>Code No.</b>	<b>90788</b>

Bimetal Saw Band, Type I for BBS 750 (tooth pitch 22 mm = 0.86 in)	
	34 x 0,9 x 4140 mm
<b>Code No.</b>	<b>90896</b>

Bimetal Saw Band, Type II for BBS 500 (tooth pitch 12.8 mm = 0.5 in)	
	27 x 0,9 x 3110 mm
<b>Code No.</b>	<b>90793</b>

Bimetal Saw Band, Type II for BBS 500 B (tooth pitch 12.8 mm = 0.5 in)	
	27 x 0,9 x 3340 mm
<b>Code No.</b>	<b>90787</b>

Bimetal Saw Band, Type II for BBS 750 (tooth pitch 22 mm = 0.86 in)	
	34 x 1,1 x 4140 mm,
<b>Code No.</b>	<b>90897</b>

Bimetal Saw Band, Type III for BBS 500 (tooth pitch 22 mm = 0.86 in)	
	34 x 0,9 x 3110 mm
<b>Code No.</b>	<b>90794</b>

Bimetal Saw Band, Type III for BBS 500 B (tooth pitch 22 mm = 0.86 in)	
	34 x 0,9 x 3340 mm
<b>Code No.</b>	<b>90789</b>

Bimetal Saw Band, Type III for BBS 750 (tooth pitch 22 mm = 0.86 in)	
	41 x 1,1 x 4140 mm
<b>Code No.</b>	<b>90899</b>

## Vertical short log splitters

- HS 71/2 (230 V)
- HS 71/2 (400 V)
- HS 61/3 Tornado
- HS 80/3 E
- HS 80/3 B



After new  
Safety standard EN 609-1

Log splitter



Hand lever protection

stable wooden stock

additional storage compartments for easy, comfortable and safe working

Standard wheel arrangement included

### Vertical short log splitters

Technical Data	<b>HS 71/2 (230 V)</b>
Power / motor	Electric, 230 V
Rated power	2,2 kW P <sub>1</sub>
Splitting power	6 t
Splitting stroke length	520 mm
Log length	550 mm
Speed	-
Return speed	-
Height w. retracted cylinder (down)	1100 mm
Height with uplifted cylinder	1600 mm
Dimensions (W x L)	980 x 860 mm
Weight	approx. 135 kg (297.6 lb)
<b>Code No.</b>	<b>91278</b>

# Accessories for log splitters **Short wood splitter up to max. 55 cm cutting**

**Splitting wedge**



	for all vertical splitters
<b>Code No.</b>	<b>90302</b>

**Cleaving wedge**



	for all vertical splitters
<b>Code No.</b>	<b>90303</b>

**Wedge extension**



	for log splitter HS 90
<b>Code No.</b>	<b>90336</b>

Here you will find a first-class product according to the new safety standard EN 609-1, which is durable, durable and easy to service.

Our short wood splitters are versatile for logs up to max. 55 cm in length. Perfectly equipped splitters with a very attractive price-performance ratio. The most robust Steel tube frame guarantees high stability and safe working.

- Rugged, easy-to-use and maintenance-less
- Effortless, user-friendly operation
- Two-hands control
- Inbuilt two-speed system (fast return stroke)
- High quality paint, scratch-proof and weather resistant powder coating
- Motor safety switch and phase changer included in price (for 400 V models)

HS 71/2 (400 V)	HS 61/3 Tornado	HS 80/3 E	HS 80/3 B
Electric, 400 V, 16 A EC plug	Electric, 400 V, 16 A EC plug	Electric, 400 V, 16 A EC plug	Gasoline engine
3,0 kW P <sub>1</sub>	4,0 kW P <sub>1</sub>	4,0 kW P <sub>1</sub>	3,7 kW / 5,0 PS
7 t	6 t	8 t	8 t
520 mm	500 mm	500 mm	500 mm
550 mm	550 mm	550 mm	550 mm
-	5,5 s / 550 mm	7,0 s / 550 mm	5,5 s / 550 mm
-	2,0 s / 550 mm	3,5 s / 550 mm	3,0 s / 550 mm
1100 mm	1100 mm	1100 mm	1100 mm
1600 mm	1600 mm	1600 mm	1600 mm
980 x 860 mm	600 x 1000 mm	600 x 1000 mm	600 x 1000 mm
approx. 135 kg (297.6 lb)	approx. 160 kg (352.7 lb)	approx. 165 kg (363.7 lb)	approx. 225 kg (496 lb)
<b>91279</b>	<b>91323</b>	<b>91324</b>	<b>91325</b>

## Horizontal short log splitters

- SM 301 (230 V)
- SM 301 (400 V)

**NEW**

After new  
Safety standard EN 609-1



## Accessories



### „Perfekt Plus“ wheel set

The „Perfekt plus“ wheel set comprises: a front steering wheel with brakes and pneumatic tires, two large pneumatic tyres with mounting plates, 4-way wedge with steering lever.

<b>Code No.</b>	<b>90284</b>

## Powerful cutting of logs up to 55 cm in length

- Two-stage hydraulic pump for increased ram forward speed (fast splitting cycle)
- Automatic return cycle
- Motor safety switch and phase changer included in price (for 400V models)
- Compact structure saves storage space
- Capable of handling even hard wood chunks by repeated-splitting cycles
- User-friendly, two-hands safety control



**Split four in one go:**  
A special slip-on 4-ways wedge is available extra as an accessory.



**A manual adjustment screw allows safe stroke adjustment, and splitting of short logs at any intermediate position.**

### Horizontal short log splitters

Technical Data	SM 301 (230 V)	SM 301 (400 V)
Power / motor	Electric, 230 V	Electric, 400 V
Rated power	2,2 kW P <sub>1</sub>	3,0 kW P <sub>1</sub>
Splitting power	6 t	6 t
Splitting stroke length	-	-
Log length	max. 550 mm	max. 550 mm
Speed	-	-
Return speed	-	-
Dimensions (W x L x H)	1520 x 600 x 1200 mm	1500 x 600 x 1200 mm
Transport dimensions (W x L x H)	1200 x 600 x 1200 mm	1200 x 600 x 1200 mm
Weight	approx. 165 kg (363.8 lb)	approx. 165 kg (363.8 lb)
<b>Code No.</b>	<b>91292</b>	<b>91291</b>

# Vertical longwood splitters

- USP 13 HZ/7
- USP 13 HZE/7

**NEW**

After new  
Safety standard EN 609-1

Log length and  
Return speed sind  
an der Vierkant-  
stange mittels 2  
Kreuzgriffschrau-  
ben stufenlos  
einstellbar.



**NEW**

Mechanical log lifter  
(Standard)

2 wooden stirrups for easy  
installation and thus safe  
working



# 13 t Vertical Log Splitter with combined power source



The lower linkage pins are adjustable in 8 positions by simply sliding them out or tipping them up/down as shown in the picture. This system provides for universal hitching to any kind of tractor.



The ram stroke of all PTO models USP 13/16/22 is hydraulically controlled by an over-dimensioned cast-iron pump.

- Two-stage control valve for increased ram forward speed (fast splitting cycle)
- Stainless brass pads allow smooth sliding of the wedge and longer frame life.
- Mechanical two-hands control
- Fully retractable ram for road transportation and storage purposes
- Solid steel frame with inbuilt hydraulic oil tank
- Advanced technology with cast iron pumps - reduced noise for PTO variants
- mechanical log lifter as standard



For more **ACCESSORIES** please see page 20

Vertical longwood splitters		
Technical Data	USP 13 HZ/7	USP 13 HZE/7
Power / motor	PTO shaft	PTO shaft and E-Motor, 400 V, 16 A EC plug
Rated power	Tractor power: 20 kW / 27 PS	Tractor power: 20 kW / 27 PS E-Motor: 5,5 kW P <sub>1</sub>
Splitting power	13 t	13 t
Log length	max. 1100 mm	max. 1100 mm
Extended piston rod (all UP)	1050 mm	1050 mm
Cylinder forward speed w. PTO drive	9/7/1050 s/mm	9/7/1050 s/mm
Cylinder return speed with PTO drive	5/1050 s/mm	5/1050 s/mm
Cylinder forward speed w. electric drive	-	15/8/1050 s/mm
Cylinder return speed w. electric drive	-	6/1050 s/mm
Height w. retracted cylinder (down)	2000 mm	2000 mm
Height with uplifted cylinder	2800 mm	2800 mm
Dimensions (W x L x H)	800 x 1200 x 2000 mm	800 x 1200 x 2000 mm
Weight	approx. 365 kg (804.7 lb)	approx. 455 kg (1003.1 lb)
<b>Code No.</b>	<b>93623</b>	<b>93622</b>

## Vertical longwood splitters

- USP 16 HZ/3
- USP 16 HZE/3
- USP 22 HZ/3

*The winch ASW 750 is designed to pull tough-to-lift chunks on the splitter. Eventually retro-fitting on previous purchases.*

*Cylinder stroke 1,050 mm, can be lowered without tools*

*2 wooden stirrups for easy installation and thus safe working*

**NEW**

After new  
Safety standard EN 609-1

**NEW**

Mechanical log lifter  
(Standard)



USP 16 HZE/3in transport asset with the cylinder retracted all the way down with optional winch ASW 750 F (Code No. 96351).



*Winch designed to pull tough-to-lift chunks on the splitter. Splitting firewood was never so fun before! Here pictured with log lifter model ASW 750 (accessory also for retro-fitting). The model ASW 750 is available (extra) as a mechanical variant (Code No. 96350) or a remotely radio-controlled variant (Code No. 96351).*



## Premium models according to new safety standard



*An upper handle is located on the left-hand side of the frame and used to secure the log central under the wedge. At the same time, another handle on the right-hand side is pushed down to control the cylinder valve. The upper handle on the left side has a holding and a control function.*

- Two-stage control valve for increased ram forward speed (fast splitting cycle)
- Stainless brass pads allow smooth sliding of the wedge
- Mechanical two-hands control
- Fully retractable ram for road transportation and storage purposes
- Solid steel frame with inbuilt hydraulic oil tank
- Advanced technology with cast iron pumps – Reduced noise for PTO variants
- Standard Universal hitching to any kind of tractor Cat. I or II
- Log fenders in price
- Mechanical log lifter as standard



For more **ACCESSORIES** please see page 20

### Vertical longwood splitters

Technical Data	USP 16 HZ/3	USP 16 HZE/3	USP 22 HZ/3
Power / motor	PTO shaft	PTO shaft and E-Motor 400 V 16 A EC plug	PTO shaft
Rated power	Tractor power: 20 kW / 27 PS	Tractor power: 20 kW / 27 E-Motor: 5,5 kW P <sub>1</sub>	Tractor power: 20 kW / 27 PS
Splitting power	16 t	16 t	22 t
Log length	max. 1100 mm	max. 1100 mm	max. 1100 mm
Extended piston rod (all UP)	1050 mm	1050 mm	1050 mm
Speed Stufe 1	12/1050 s/mm	12/1050 s/mm	13/1050 s/mm
Speed Stufe 2	6/1050 s/mm	6/1050 s/mm	6/1050 s/mm
Return speed	7/1050 s/mm	7/1050 s/mm	8/1050 s/mm
Height w. retracted cylinder (down)	1980 mm	1980 mm	2008 mm
Height with uplifted cylinder	2800 mm	2800 mm	2800 mm
Dimensions (W x L x H)	1300 x 1300 x 2700 mm	1300 x 1300 x 2700 mm	1300 x 1300 x 2700 mm
Weight	approx. 455 kg (1003.1 lb)	approx. 480 kg (1058 lb)	approx. 455 kg (1003.1 lb)
<b>Code No.</b>	<b>93633</b>	<b>93632</b>	<b>93643</b>

# Horizontal longwood splitters

- SP 30 HZH/2S
- SP 30 HZEH/2S
- SP 30 HEH/2S

**NEW**

After new  
Safety standard EN 609-1

Serienmäßig mit hydraulisch  
verstellbarem Spaltkreuz 4-Teile

Log splitter

EC-approved two-hands  
control

Sliding cylinder fully  
retractable for road  
transportation

Rugged timber carriage



For more **ACCESSORIES**  
please see page 21



Picture shows SP 30 HZH / S according to old directive.



The fast forward speed of the hydraulic ram is made possible by the oversized hydraulic pump group III. A tandem pump is flanged to the main pump to power all ancillary functions as wedge lift and log lift operations.



Ergonomic and safe operation. All machine functions are controlled from a very accessible operator's stand with overall view on the machine.



This heavy-duty splitter is capable to handle effortlessly even very hard and crooked timber full of knots.

## Spaltprofi - effective and powerful

For forestry companies and forest owners ideally suited thanks to user-friendly technology. It is a fast and delay-free working with the 30 t wood splitter according to new rule possible.

- Two-speed operation valve for shorter splitting cycles by means of 2-stage control valve
- 2 Hydraulic pumps and one dedicated hydraulic system for splitter ram operation
- No reduction of ram (splitting) speed in case of concurrent operation of different controls
- Hydraulic timber lift
- Stepless adjustable stroke length
- Hydraulic wedge lift included in price
- Large extension table at splitter outlet for clean sticks collection, whilst the next log can be loaded on the splitter carriage ready for the next cycle.
- Extra-large hydraulic oil tank (approx. 60 l = 13.2 gal)
- On request (extra-price), the splitter can be supplied with an optional star-wedge (6-ways)
- Operation hours counter available on request (not in price)
- Hydraulic timber lifter (folding up and down)

### Horizontal longwood splitters

Technical Data	SP 30 HZH/2S	SP 30 HZEH/2S	SP 30 HEH/2S
Power / motor	PTO shaft	PTO shaft and E-Motor, 400 V, 32 A EC plug, Delta-Star switch	Electric, 400 V, 32 A EC plug, Delta-Star switch
Rated power	Tractor power: 35 kW / 48 PS	Tractor power: 35 kW / 48 PS E-Motor: 7,5 kW P <sub>2</sub> / 9,5 kW P <sub>1</sub>	7,5 kW P <sub>2</sub> / 9,5 kW P <sub>1</sub>
Splitting power	30 t	30 t	30 t
Log length	max. 1250 mm	max. 1250 mm	max. 1250 mm
Speed	max. 9 cm/s	max. 9 cm/s	max. 9 cm/s
Fast cylinder forward	max. 21 cm/s	max. 21 cm/s	max. 21 cm/s
Cylinder return speed with PTO drive	max. 14 cm/s	max. 14 cm/s	-
Transport dimensions (W x L x H)	2990 x 1850 x 1660 mm	2990 x 1850 x 1660 mm	2990 x 1850 x 1660 mm
Dimensions (W x L x H)	4050 x 2050 x 1590 mm	4050 x 2050 x 1590 mm	4050 x 2050 x 1590 mm
Weight	approx. 1068 kg (2354.5 lb)	approx. 1140 kg (2513.3 lb)	approx. 1094 kg (2411.8 lb)
<b>Code No.</b>	<b>93670</b>	<b>93671</b>	<b>93672</b>

## Accessories for USP models

Slip-on 4-way wedge	
	for all USP types 13, 16 and USP 22.
<b>Code No.</b>	<b>94716</b>

Hydraulic winch ASW 750 M	
	for USP 13, 16 and 22 with idle
	Pull force: 750 kg (1653.5 lb) 30 m (98.4 ft) rope in Ø 6 mm (0.2 in), including pulley
	accessory also for retro-fitting pressure transmission via oil pressure lines
	Hand-lever-operated
<b>Code No.</b>	<b>96350</b>

Hydraulic winch ASW 750 F	
	for USP 13, 16 and 22 with idle
	Pull force: 750 kg (1653.5 lb) 30 m (98.4 ft) rope in Ø 6 mm (0.2 in), including pulley
	accessory also for retro-fitting pressure transmission via oil pressure lines
	Remote operation through a 3-channel radio control, including receiver and sender
<b>Code No.</b>	<b>96351</b>

Tow bar with steering wheel	
	For all USP types 13, 16 and 22
	For convenient transportation of BGU log splitters on a smooth and firm ground
<b>Code No.</b>	<b>94757</b>

PTO shaft	
	Cat. 1, 1 3/8"
	6 splines, 1 m (3.3 ft) long
	suitable for all Saw & Splitter processors as well as all logging winches up to FSW 4.5 and GSZ 242 Combi
<b>Code No.</b>	<b>95060</b>

**TOP EFFICIENCY!**  
These accessories are designed for throughout easier and safer working conditions both on a yard and in the woods!

## Accessories for horizontal log splitters, models SP

### Hydraulic timber lifter ASW 750 M for SP 30



with idle  
 Pull force: 750 kg (1653.5 lb)  
 30 m (98.4 ft) rope in Ø 6 mm  
 (0.2 in), including pulley  
 fixation brackets for retro-fitting on  
 previously purchased SP 30  
 Mechanical operation with hand  
 crank and rope pull

**Code No. 96355**

### Hydraulic timber lifter ASW 750 F for SP 30



with idle  
 Pull force: 750 kg (1653.5 lb)  
 30 m (98.4 ft) rope in Ø 6 mm  
 (0.2 in), including pulley  
 fixation brackets for retro-fitting on  
 previously purchased SP 30  
 Remote operation through a 3-channel  
 radio control, including receiver  
 and sender

**Code No. 96356**

### Splitting wedge



4-way splitter wedge  
**Code No. 94746**

6-way wedge (star-shaped)  
**Code No. 94747**



# Saw & Splitter Combination

- SSM 271 Z
- SSM 270 EZ

**SSM 270 EZ:** A standard set of built-in, extendible guide rollers prevents tipping over when working with long timber up to 3 m (9.8 ft).

Equipped with standard timber retainer conveniently installed near the operator's control station for user-friendly operation.

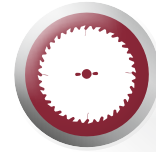

**STANDARD WIDIA BLADE**

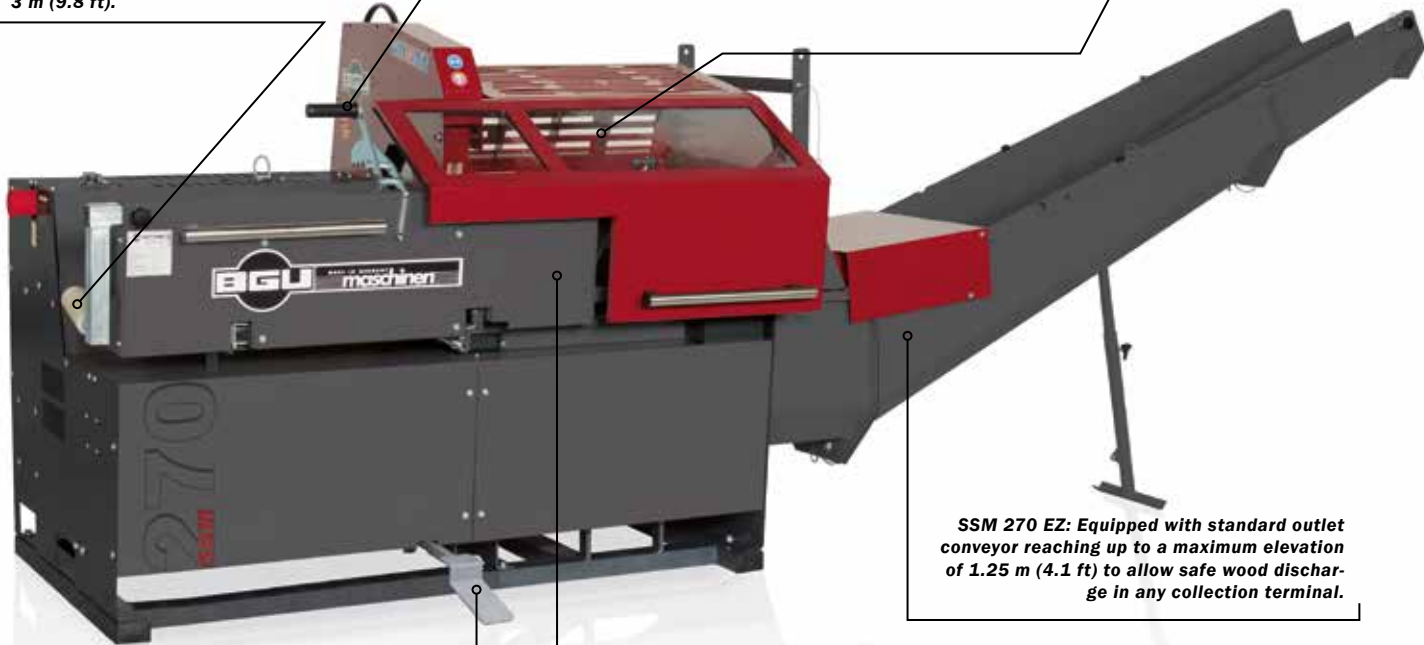

**SSM 270 EZ:** Equipped with standard outlet conveyor reaching up to a maximum elevation of 1.25 m (4.1 ft) to allow safe wood discharge in any collection terminal.

The splitter is started by a foot pedal control. The wedge position is adjustable up and down so the it is possible to split the log in 4 or 2 pieces depending on your requirements.



Every time when the safety grid over the splitter unit is lifted up, the hydraulic ram of the splitter is locked (interlock safety). For safety reasons the log splitter will not start while the safety grid is uplifted and the saw blade is fully enclosed beneath a



Without discharge channel

# The entry level model of Saw splitting technique

**Working mechanism and operation system:** The machine attaches to the 3-point linkage of any agricultural tractor and operates from its rear power-take-off drive by means of a PTO shaft. Alternatively the machine is also available in an electric variant with built-in motor. The log splitter is controlled by a foot pedal. The logs are cut in 2 or 4 pieces depending on adjustment of the wedge height. The cut piece drops onto the log carriage in the splitter and a hydraulic driven push-block forces the log against the wedge and out of the splitting unit while the saw is ready for the next cutting cycle. This combination of two separate sections and simultaneous log advancing/cutting and splitting assures great time and money savings.

- Three-point linkage included
- Inbuilt hydraulic system for power drive through a PTO shaft
- Extensible infeed rollers providing additional support for long timber (up to 3.0 m = 9.8 ft)
- SSM 271 Z: basically without discharge channel and without differential valve
- SSM 270 EZ: Two-stage differential valve for increased ram forward speed splitting cycles, Equipped with outlet conveyor (reaching up to 1.25 m (4.1 ft) high and discharge into a pallet underneath). The conveyor folds up for transportation.
- Three-point hitch and PTO shaft on the back side of the machine
- Simple and easy to handle on a fork lift



**SSM 270 EZ:**  
Differential valve for increased ram forward speed (fast splitting cycle).



An extra-large hydraulic tank provides for consistent oil temperature even in case of continuous operation.



The splitter wedge can be quickly and safely raised/lowered to the required level by means of a control hand-lever.



A safety valve prevents accidental restart of the splitter, while the safety guard is up-lifted.



4-ways wedge: For a clean production of split logs, all in the same size.



Adjustable log length (250 - 500 mm / 9.8 - 19.7 in)



Transport asset with outlet spout folded up and timber infeed rollers retracted.

## Saw & splitter combination

Technical Data	SSM 271 Z	SSM 270 EZ
Power / motor	PTO shaft	PTO and 400V electric motor
Rated power	Tractor power: 12 kW / 16 PS	Tractor power: 12 kW / 16 PS E-Motor: 9,2 kW P <sub>1</sub> S6 40% ED
PTO shaft speed	420 Rpm	420 Rpm
Cutting capacity (log Ø)	approx. 270 mm	approx. 270 mm
Log (cutting) length	Adjustable: 250-500 mm	Adjustable: 250-500 mm
Blade diameter Ø	700/30 mm	700/30 mm
Dimensions (W x L x H)	4100 x 1350 x 1320 mm	4100 x 1350 x 1320 mm
Weight	approx. 570 kg (1256.6 lb)	approx. 670 kg (1477.1 lb)
<b>Code No.</b>	<b>95051</b>	<b>95048</b>

# Automatic Chainsaw Processor

- KSA 380 Z
- KSA 380 E

The hydraulic chainsaw unit is equipped with a long chainsaw bar operated by the user all the way down through the timber. In this partially manual system, the operator regulates the pressure on the timber and, consequently, the cutting speed based on timber thickness and diameter



The plastic guide roller at timber infeed provide additional timber support and prevent timber from falling down.

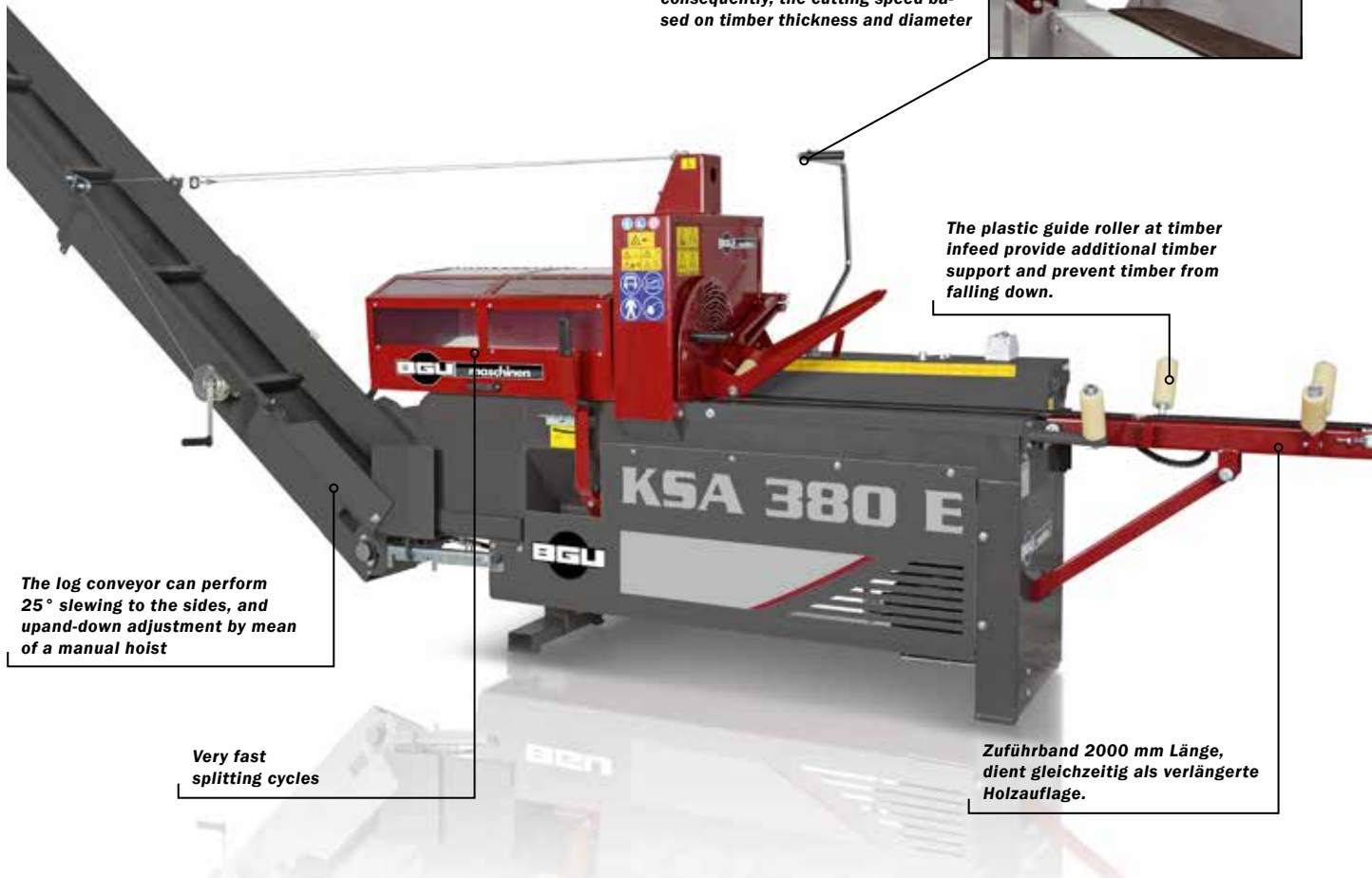

The log conveyor can perform 25° slewing to the sides, and up-and-down adjustment by means of a manual hoist

Very fast splitting cycles

Zuführband 2000 mm Länge, dient gleichzeitig als verlängerte Holzauflage.



For more ACCESSORIES please see page 30

KSA 380 folded in transport position. Both belt conveyor and infeed belt can be effortlessly folded up by means of separate hydraulic controls.





A special inbuilt, adjustable length stop is designed to help accurately position and cut the log in any length between 20 and 60 cm (7.9 – 23.6 in). Wedge lift is performed up and down in 6 different positions by means of a special ergonomic hand lever.



Special V-shaped carriage makes it easier to accommodate and split small, crooked or deformed timber that safely rolls down to the bottom and therefore perfectly centred against the wedge.



A multifunctional control lever is used to engage the saw. Pull it down to the first step to operate the chain saw and start cutting and hold it in position until the chainsaw has completely cut the timber through. This system has the additional benefit of avoiding waste of saw chain oil.



Hydraulic quick couplings  
Coupling arrangement for attachment of a timber deck or rack to be controlled by the multifunctional lever to advance timber on a roller belt to the saw.



Accurate finish in all details: the machine is standing on square channels for handling on a fork lift or trolley. Alternatively, they can be used or fitting on the lower pins of the 3-point hitch and transport the machine on your tractor.

## Saw & Splitter Combination for timber diameter up to 37 cm

- Noiseless chainsaw operation
- The oversized pumping capacity (45 l/min = 9.9 gal/min) ensures faster splitting cycles; Moreover, saw-cutting and splitting can be controlled and executed nearly concurrently even with soft, thinner timber
- Two hydraulic pumps with two separate circuits:
  - 1 pump for log splitter operation (45 l/min = 9.9 gal/min) and 1 pump for chainsaw and infeed belt operation (30 l/min = 6.6 gal/min)
- Emergency splitter stop by means of a safety hand-lever control
- Multifunctional control lever designed for controlling four machine functions
- Hydraulic log conveyor
- Standard oil cooler to allow for trouble-less, non-stop operation.
- 4-way wedge included in price

### Automatic Chainsaw Processor

Technical Data	KSA 380 Z	KSA 380 E
Power / motor	PTO shaft	400 V Electric motor + 32 A EC plug, Delta-star switch
Rated power	Tractor power: 20 kw / 27 PS	E-Motor: 7,5 kW P <sub>2</sub> / 9,5 kW P <sub>1</sub>
PTO shaft speed	420–450 Rpm	–
Cutting capacity (log Ø)	max. 370 mm	max. 370 mm
Log length	Adjustable: 200–520 mm	Adjustable: 200–520 mm
Chainsaw bar	15"/380 mm	15"/380 mm
Chain	3/8" / 1,5 / 57 TG	3/8" / 1,5 / 57 TG
Oil capacity	42 l	42 l
Splitting power	9 t	9 t
Output	4–6 cord/h	4–6 cord/h
Length of the conveyor	4200 mm	4200 mm
Width of the conveyor belt	300 mm	300 mm
Elevation of the log conveyor	max. 2700 mm	max. 2700 mm
Transport dimensions (W x L x H)	2780 x 1100 x 2550 mm	2780 x 1100 x 2550 mm
Weight	approx. 825 kg (1818.8 lb)	approx. 825 kg (1818.8 lb)
<b>Code No.</b>	<b>91916</b>	<b>91915</b>

# Automatic Chainsaw Processor

- KSA 385 Z Select
- KSA 385 EZ Select

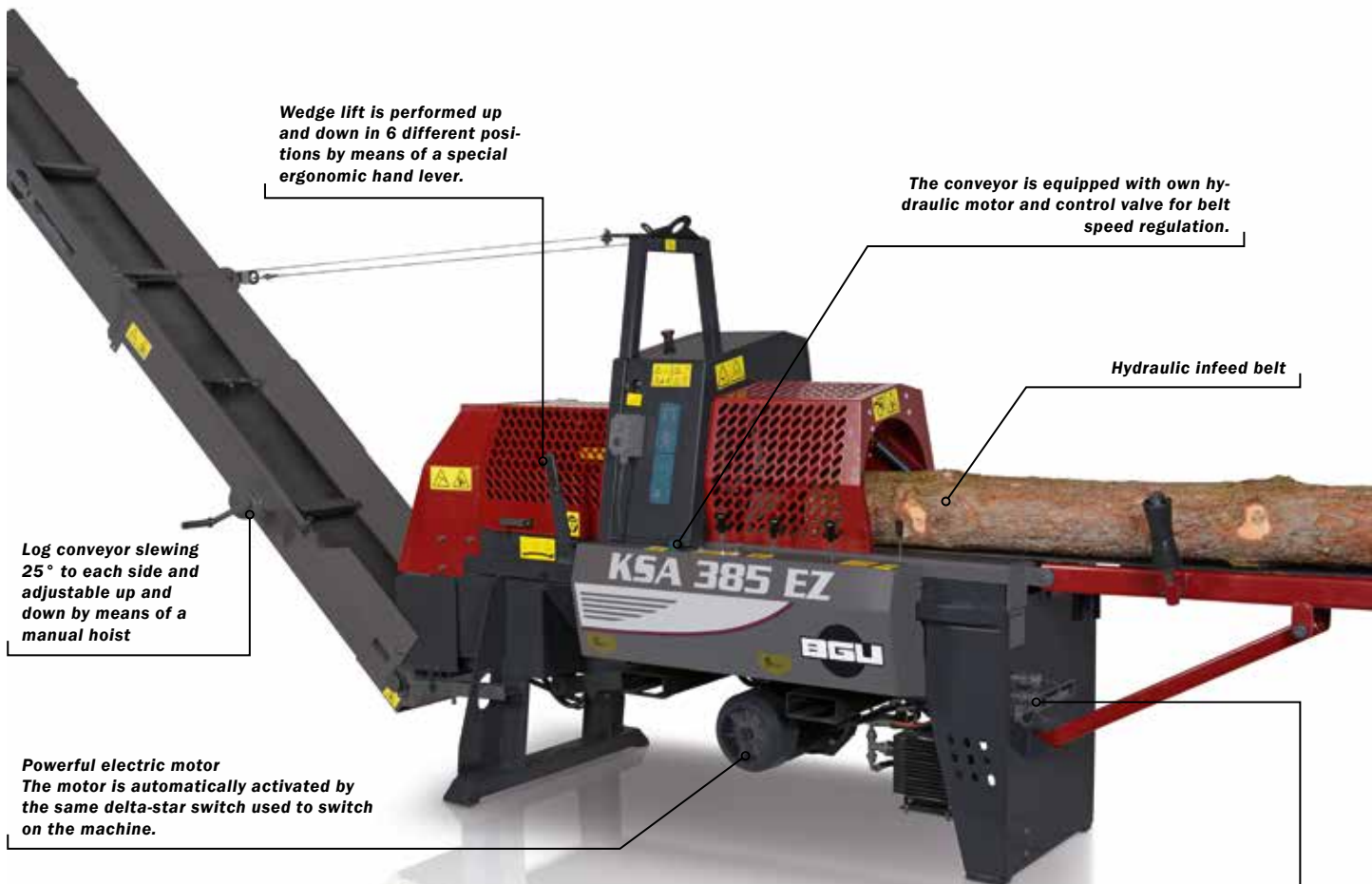

Wedge lift is performed up and down in 6 different positions by means of a special ergonomic hand lever.

The conveyor is equipped with own hydraulic motor and control valve for belt speed regulation.

Hydraulic infeed belt

Log conveyor slewing 25° to each side and adjustable up and down by means of a manual hoist

Powerful electric motor  
The motor is automatically activated by the same delta-star switch used to switch on the machine.

Hydraulic quick couplings:  
for attaching an infeed deck or rack to be controlled via the main control valves of the machine (timber to be fed both from the side or the front).



KSA 385 folded closed in transport position.



For more **ACCESSORIES**  
please see page 30

## Automatic Chainsaw Processors with control joysticks



A hydraulic valve is available to stop the infeed table as needed. Before starting the machine, the valve settings can be changed to command cutting logs of the required length.



The saw chain is only engaged, after the descent of the chainsaw. This safety system has been designed for a longer life of the saw bar and chain at the same time.



Ergonomic, easy accessible control board The descent speed of the chainsaw to and through the timber can be conveniently adjusted by means of a regulator (valve) installed on the control panel.



A safety valve stops all hydraulic functions and prevents accidental restart while the safety guard is lifted up. This additional safety ensures compliance to the EC norms and directives.



All processors model KSA 385 come with standard oil cooler to allow non-stop operation.

- Noiseless chainsaw operation
- Hydraulic timber rack with forward and reverse operation
- Built-in hydraulics
- Control-joysticks
- Powerful electric motor with 7.5 kW power output (= 100% power-on time and 9.5 input power)
- 2.3 m (7.5 ft) long infeed table
- Production specimen approved to EC safety requirements
- Oversized pumping capacity (45 l/min = 9.9 gal/min) for fast splitting cycles; Moreover, saw-cutting and splitting can be controlled and executed nearly concurrently even with soft, thinner timber.
- Standard 6-way wedge

### Automatic Chainsaw Processor

Technical Data	KSA 385 Z Select	KSA 385 EZ Select
Power / motor	PTO shaft	PTO + Electric motor 400 V, 32 A EC plug, Delta-Star switch
Rated power	Tractor power: 20 kW / 27 PS	Tractor power: 20 kW / 27 PS E-Motor: 7,5 kW P <sub>2</sub> / 9,5 kW P <sub>1</sub>
Cutting capacity (log Ø)	max. 370 mm	max. 370 mm
Log length	Adjustable: 200–550 mm	Adjustable: 200–550 mm
Chainsaw bar	15"/380 mm	15"/380 mm
Chain	3/8" / 1,5 / 57 TG	3/8" / 1,5 / 57 TG
Oil capacity	42 l	42 l
Splitting power	9 t	9 t
Length of the conveyor	4200 mm	4200 mm
Width of the conveyor belt	300 mm	300 mm
Transport dimensions (W x L x H)	2810 x 1280 x 2530 mm	2810 x 1280 x 2530 mm
Dimensions (W x L x H)	6650 x 1280 x 3240 mm	6650 x 1280 x 3240 mm
Weight with conveyor	approx. 855 kg (1885 lb)	approx. 895 kg (1973.1 lb)
<b>Code No.</b>	<b>90986</b>	<b>90985</b>

# Automatic Chainsaw Processor

• KSA 455 EZ

The log conveyor is equipped with own hydraulic motor and control valve for belt speed regulation.

Swivelling boom with manual hoist to facilitate replacement of heavy splitter tools and parts.

Hydraulic infeed belt

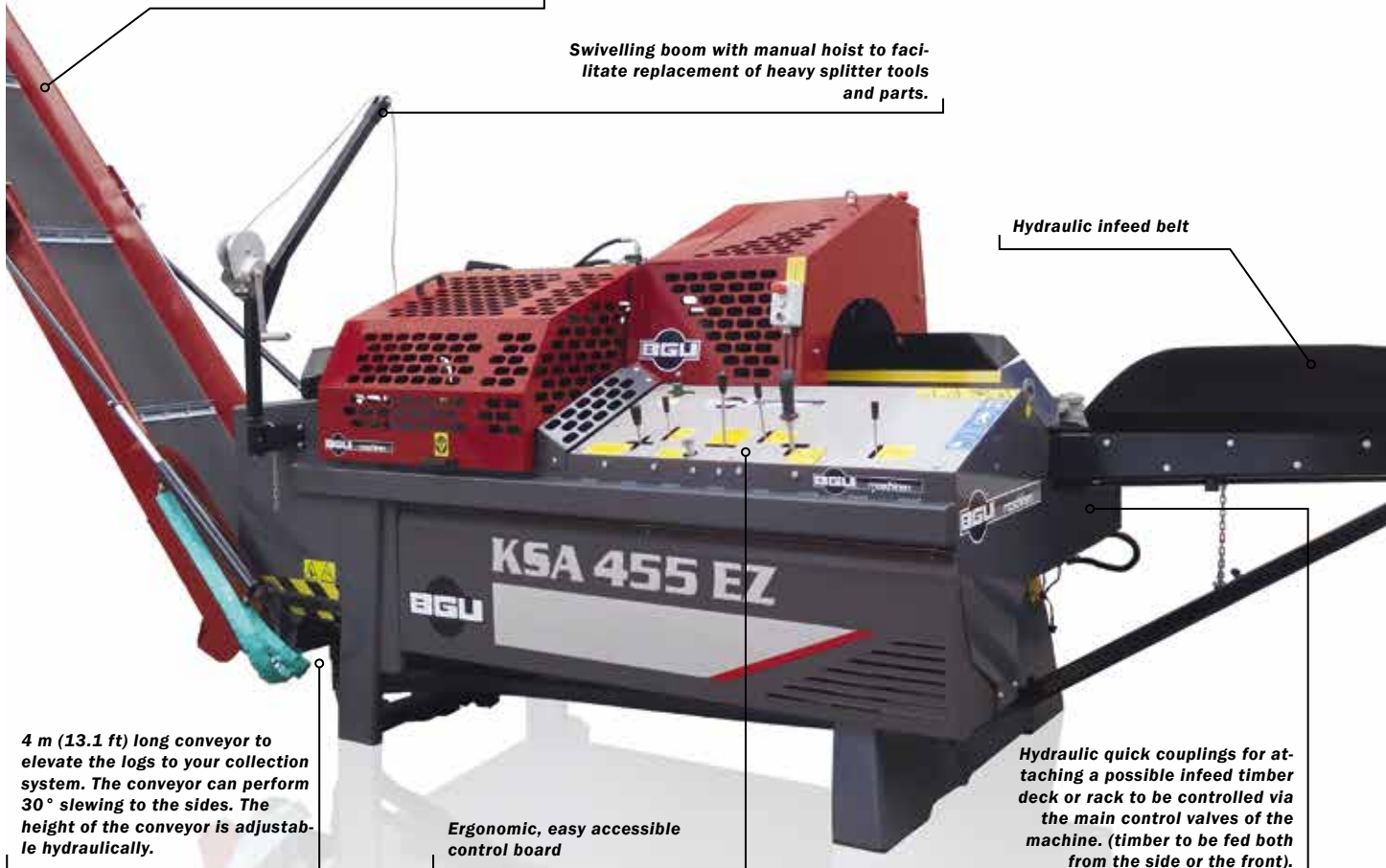

4 m (13.1 ft) long conveyor to elevate the logs to your collection system. The conveyor can perform 30° slewing to the sides. The height of the conveyor is adjustable hydraulically.

Ergonomic, easy accessible control board

Hydraulic quick couplings for attaching a possible infeed timber deck or rack to be controlled via the main control valves of the machine. (timber to be fed both from the side or the front).



For more **ACCESSORIES**  
please see page 30

## High tech for the forest enterprise



**An hydraulic slider secures the logs and stops them from rolling down. Even if the last timber piece is too short, it will still roll down straight and centrally in the splitter carriage**



- Hydraulic infeed belt and wedge lift included in price.
- Dual power: the variant KSA 455 EZ can be PTO-powered from the tractor or by the built-in electric motor
- Powerful electric motor with 15 kW power output = 100% power-on time and 9.5 input power
- Two splitting rams respectively 70 mm (2.7 in) and 100 mm (3.9 in)
- Standard 8-way wedge
- Automatic activation of the second ram with 24 t (23.6 lt) splitting force
- Hydraulic push-down for safe cutting of the last timber piece
- Hydraulic slider to control the rolling of the logs into the splitter carriage
- 12-way wedge available extra on request



**The saw chain is only engaged, after the descent of the chainsaw. So, no waste of oil and no early wear of the chainsaw bar will occur.**



**A hydraulic valve is available to allow stopping the infeed belt in the Stop-position. To set the log length (adjustable from 200 up to 600 mm / 7.9-23.6 in), simple move the valve by the required distance before starting to work.**



**A push-down roll holds and secures the log in position while cutting is performed. This allows safe cutting of any timber to the very last piece.**





**All KSA processors 455 EZ are equipped with a standard oil cooler.**

### Automatic Chainsaw Processor

Technical Data	KSA 455 EZ
Power / motor	PTO + Electric motor 400 V, 32 A EC-plug Delta-star switch
Rated power	Tractor power: 25 kW / 34 PS E-Motor: 15 kW P <sub>2</sub> / 20 kW P <sub>1</sub>
Cutting capacity (log Ø)	max. 450 mm
Log length	Adjustable: 200-660 mm
Chainsaw bar	20"/508 mm
Chain	.404" / 1,6 / 71 TG
Oil capacity	100 l
Splitting power	24 t
Length of the conveyor	4000 mm
Width of the conveyor belt	400 mm
Transport dimensions (W x L x H)	3300 x 1800 x 2600 mm
Dimensions (W x L x H)	8500 x 1800 x 3100 mm
Weight with conveyor	approx. 2350 kg (5180.8 lb)
<b>Code No.</b>	<b>90926</b>

## Accessories KSA 380

4-way splitter wedge		
		for KSA 380
Code No.	90097	

Heavy-duty chainsaw bars		
		3/8" / 1,5
Code No.	95073	

6-way wedge (star-shaped)		
		for KSA 380
Code No.	90018	

Spare saw chain		
		3/8" / 1,5 / with 57 sprockets
Code No.	95071	

## Accessories KSA 385

4-way splitter wedge		
		for KSA 385
Code No.	90023	

Heavy-duty chainsaw bars		
		3/8" / 1,5
Code No.	95073	

6-way wedge (star-shaped)		
		for KSA 385
Code No.	90027	

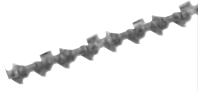
Spare saw chain		
		3/8" / 1,5 / with 57 sprockets
Code No.	95071	

## Accessories KSA 455

8-way wedge (star-shaped)		
		for KSA 455
Code No.	90021	

Harvester chainsaw bars		
		.404" / 1,6
Code No.	95075	

12-way splitter wedge (star-shaped)		
		for KSA 455
Code No.	90019	

Spare saw chain		
		.404" / 1,6 / with 57 sprockets
Code No.	95077	

## Other accessories

PTO shaft	
	Class. 1, 1 3/8"
	6 splines, 1 m (3.3 ft) long for all PTO saws and splitters as well as for all winches up to FSW 4.5
<b>Code No.</b>	<b>95060</b>

Hydraulic log lifter	
	for all KSA models including matching hydraulic hoses
<b>Code No.</b>	<b>90988</b>



## Garden shredder

- GSE 20 Woody
- GSB 20 Woody

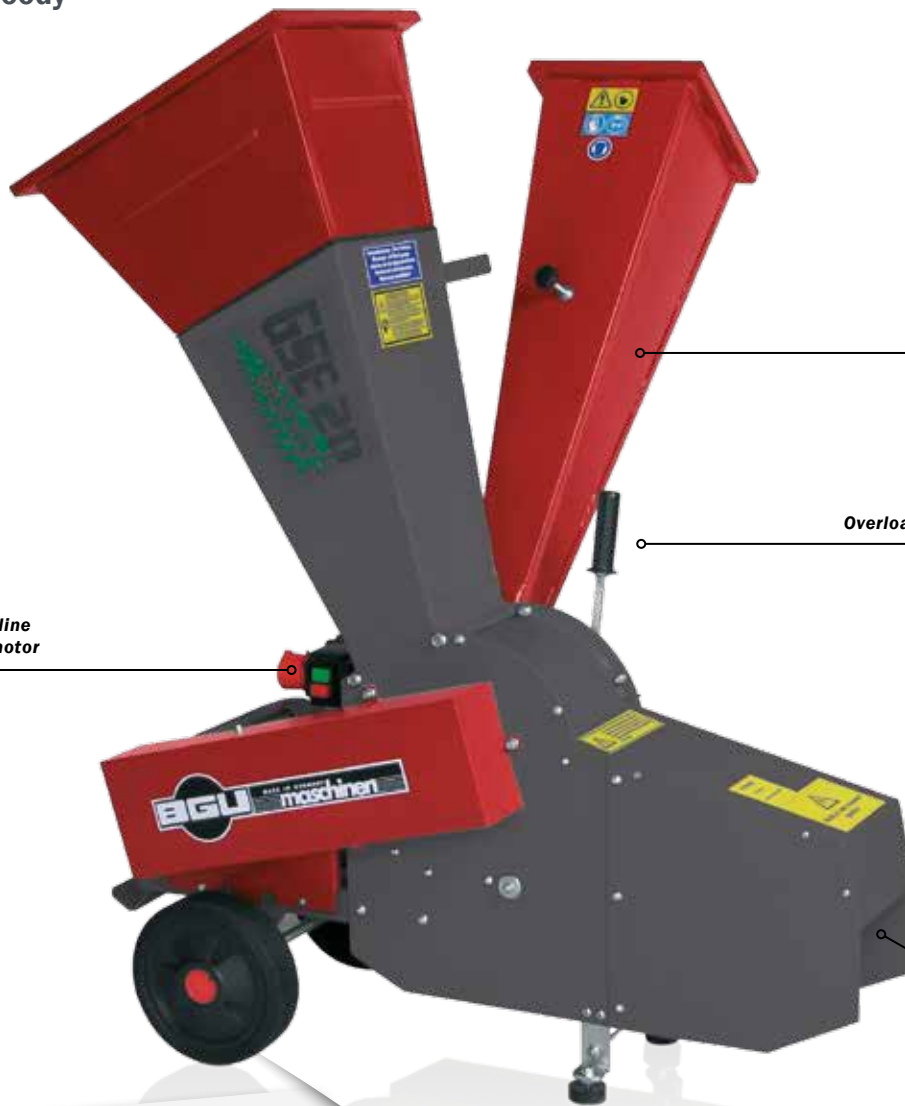

High-quality powder painting, scratch-proof and resistant to weathering agents

Overload safety

Available with gasoline engine or electric motor

The discharge chute directs the shredded material to the ground





## Entry level model for the garden area

A German brand product that meets your expectations for a Garden shredder.

Two machines in one: a combination machine equipped with shredding hammers and disc blade chipping device. These machines are powerful and robust in shredding your shredded material.

- Shreds branches and waste up to Ø 65 mm (2.5 in)
- Equipped with two built-in chipping blades
- Equipped with swinging cutting hammers out of special hardened steel
- Durable rotor with built-in lateral disc blade
- High quality paint, scratch-proof and weather resistant powder coating

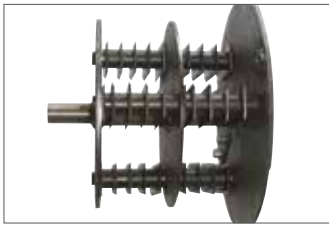

The core of this machine is an engineered rugged hammer mill drum with 30 staggered flails very easy to access and replace for maintenance.



Controllable particle size, fine or coarse compost particles size can be obtained by insetting the corresponding perforated grates under the hammer mill. This allows optimum composting performance.



A special crank lever is provided on one side of the machine to open the slotted grate and quickly remove eventual residual material clogging the machine.

Garden shredder		
Technical Data	GSE 20 Woody	GSB 20 Woody
Power / motor	Electric, 400 V, 16 A EC plug	Gasoline engine
Rated power	3,8 kW P <sub>1</sub>	3,7 kW / 5,0 PS
Motor speed	2850 Rpm	3600 Rpm
Drum speed	2400 Rpm	3100 Rpm
Drum width	200 mm	200 mm
Drum-Ø	300 mm	300 mm
Branch-Ø	max. 65 mm	max. 65 mm
Hammers	30 Pieces	30 Pieces
Dimensions (W x L x H)	1150 x 1050 x 1500 mm	1150 x 1050 x 1500 mm
Weight	approx. 122 kg (269 lb)	approx. 102 kg (225 lb)
<b>Code No.</b>	<b>94500</b>	<b>94502</b>

## Garden shredder

- GSZ 242 Combi
- GSE 242 Combi
- GSB 242 Combi



Max. branch diam.  
100 mm (3.9 in)

High quality paint, powder  
coating, scratch-proof and  
weather resistant

PTO shafts are accesso-  
ries available at  
extra-price  
(Code No. 95060)

Lower and upper  
discharge chute

## Accessories

Spacer		PTO shaft extension	
	0,60 m (1.9 ft) long for higher discharge suitable for all models 242		
<b>Code No.</b>	<b>94560</b>	<b>Code No.</b>	<b>95061</b>



The number of sharp double-edged steel paddles on the drum surface determines the size of the final compost. The compost size is reduced by pulling the paddles (steel rods) out. The hammers and the cutting knives can be easily replaced through the special access opening provided for maintenance of the machine.



The swinging hammers mounted across the drum can be reversed and used twice. Hammers and chipping knife are all made of high-quality special steel. All bolts are made of annealed steel with surface hardening in order to avoid cracking and shrinking.

## First-class processing of your shredded material

Innovative technology for garden owners, tree services, farms a.s.o. for shredding a variety of materials.

When you need quality and efficacy, THERE WE ARE. The perfect answer to yard clean-up: shredders are have an upper, rotating, discharge chute with adjustable ejector flap to direct compost material straight into a collection bin or even shred and pile in the desired set up location saving laborious shovelling, piling and disposal. A great way to eliminate waste disposal and recycle all your organic garden debris!

- Shreds branches and waste up to Ø 100 mm (3.9 in)
- Durable rotor with built-in lateral disc blade
- Equipped with swinging cutting hammers out of special hardened steel
- User-friendly operation system
- High quality paint, scratch-proof and weather resistant powder coating
- **GSZ 242 Combi** and **GSE 242 Combi**: with 4-fold tires and push bar for easy transport.



### Garden shredder

Technical Data	GSZ 242 Combi	GSE 242 Combi	GSB 242 Combi
Power / motor	PTO shaft	Electric, 400 V, 32 A EC plug	Gasoline engine
Rated power	Tractor power: 12 kW / 16 PS	9,0 kW P <sub>1</sub>	9,6 kW / 13,0 PS
Motor speed	3600 Rpm	2850 Rpm	3600 Rpm
Drum speed	2400 Rpm	2400 Rpm	2400 Rpm
Drum width	240 mm	240 mm	240 mm
Drum-Ø	440 mm	440 mm	440 mm
Branch-Ø	max. 100 mm	max. 100 mm	max. 100 mm
Hammers	34 Pieces	34 Pieces	34 Pieces
Dimensions (W x L x H)	1600 x 1700 x 1610 mm	1650 x 1700 x 1610 mm	1900 x 1700 x 1610 mm
Weight	approx. 238 kg (524 lb)	approx. 288 kg (635 lb)	approx. 265 kg (584 lb)
<b>Code No.</b>	<b>94556</b>	<b>94554</b>	<b>94562</b>

## Log conveyor



Specific for firewood production, BGU belt conveyors efficiently deliver ready-split firewood out of the machine into whatever transport or storage container parked downstream of the machine.

A choice of electric motor (either 230V or 400 V) or set of hoses and quick couplings for power take off from your tractor hydraulics is available.

- Multifunctional (universal use)
- Basic version without drives
- Conveyor belt powered by either hydraulic motor or electric motor

## Variants

TFB 4000 - telescopically	
	Length: 4,0 m (13,1 ft) extended and 2,55 m (8,4 ft) retracted Width: 250 mm (9,84 in)
<b>Code No.</b>	<b>92206</b>

FB 2500 - not telescopic	
	Length: 2,5 m (8,2 ft) Width: 250 mm (9,84 in)
<b>Code No.</b>	<b>92208</b>

TFB 5000 - telescopically	
	Length: 5,0 m (16,4 ft) extended and 3,05 m (10 ft) retracted Width: 400 mm (15,75 in)
<b>Code No.</b>	<b>92207/1</b>

FB 5000 - not telescopic	
	Length: 5,0 m (16,4 ft) Width: 400 mm (15,75 in)
<b>Code No.</b>	<b>92209</b>

## Actuators

Hydromotor-operated belt conveyor	
	with hoses and quick couplings; power take-off from the tractor
<b>Code No.</b>	<b>92212</b>

Belt conveyor powered by:	
	400 V E-Motor with gears
<b>Code No.</b>	<b>92210</b>
	230 V E-Motor with gears
<b>Code No.</b>	<b>92211</b>

# Transfer Rack

- HZB 3000 HL

Feeding up to 4 m (13.1) long timber to saw & splitter log processors.

- High load capacity (3000 kg) (2.95 lt)
- Modular construction, entirely dismountable
- 5-steps height adjustment to match any type of machine
- V-shaped timber carriage with geared roller, with hydraulic power drive and a roller follower



## Transfer Rack

Technical Data	HZB 3000 HL
Recommended timber length	1500-4000 mm
Timber diameter	max. 400 mm
Capacity	max. 3000 kg
Length	2650 mm
Width	1400-2600 mm
V-roller height	900-1100 mm
Wheel arrangement (25 km/h)	-
Hydraulic rollers for longitudinal infeed	1 piece
Hydraulic powered chains for transversal feeding	-

<b>Code No.</b>	<b>90011</b>

## Accessories

### Hydraulic infeed roller for HZB 3000 HL



	with hydraulic hoses and outrigger. Suitable for attachment of a longitudinal transfer rack to the HZB 3000 HL
<b>Code No.</b>	<b>90008</b>

# Bundling Systems

- HBG 100/2 Euro-Kombi
- HBG 100 HS

*Hydraulic tensioner for HBG 100/2  
(Code No. 90220)*



*Safe storage of the polyester textile band and the nylon line for efficient uncoiling performance.*



*Compact design and construction*



*HBG is equipped with an inbuilt steel box for safe and clean storage of clamps, aluminium clips and other tools so that they can be always at reach when needed.*



*Use of the special EC-Combi-mount makes it possible to attach the machine either to the loader front or to the three-point hitch in the back.*



*The ratchet tensioner fits all models and can be also retro-fitted. It is the affordable alternative to any hydraulic tensioner or strapper. (Code No. 90222).*

## Said and done:



**1. Bundling**  
for bundling wood in Euro pallet size,  
as commonly in use at most firewood  
retailers



**2. Wrap and pack on Europalettes.**



**3. Shrink wrapped. Ready for sale!**

## A flawless mechanism

BGU bundlers allow on-site baling of your logs for quick further delivery to storage or shipment to the customers saving time and costly intermediate handling operations.

Our bundlers are compatible with the following log lengths:  
330 mm / 500 mm / 1000 mm ( 13/ 19.6/ 39.4 in)  
Logs just need to be loaded with one end to the upper stop plate and wrapped with a nylon strap using the ratchet chain bundler, or alternatively with a polyester-fabric band (tear resistance 750 kg = 1653.5 lb) and steel buckles using the manual strapping machine.

- The machine can be transported on the three-point-hitch of any tractor or on a front loader.
- Integrated tensioner
- Compressed and banded wood bundles are conveniently ejected from either one side
- One 140 m (460") nylon strap coil on HBG100/2 provides for approx. 15 bundles with lacing on both sides





For more accessories  
please see page 40

Bundling Systems		
Technical Data	<b>HBG 100/2 Euro-Kombi</b>	<b>HBG 100 HS</b>
Log length	330/500 oder 1000 mm	330/500 oder 1000 mm
Dimensions (W x L x H)	1215 x 1200 x 1400 mm	1215 x 1200 x 1400 mm
Weight	approx. 232 kg (511 lb)	approx. 250 kg (551 lb)
<b>Code No.</b>	<b>90101/2</b>	<b>90128</b>

# Accessories Bagging Systems

2-stroke hydraulic cylinder for HBG bundlers 100/2	
	Ancillary equipment: 2-stroke cylinder and 1.5 m (4.9 ft) hose with quick coupling for more convenient tip-over when working on a front loader (easy to retrofit, if needed later on)
<b>Code No.</b>	<b>90211</b>

Hydraulic tensioning roller for HBG 100/2	
	retro-fitting on all HBG 100/2 from manufacturing year 2012, including: a cylinder mount, a cylinder with hoses, valve, strapping cord, chain and hook
<b>Code No.</b>	<b>90224</b>

Round bale net: 1 800 m x 0.60 m (5905.5 x 1,96 ft) (height)	
	1 piece is sufficient for 40-50 packs
<b>Code No.</b>	<b>97180</b>

Polyester textile band	
	19 mm x 500 m (0.74 in x 1640.4 ft) Tear resistance: 725 kg (1598.3 lb)
<b>Code No.</b>	<b>90118</b>

Steel tube adapter	
	to unwind the polyester textile band
<b>Code No.</b>	<b>90124</b>

Nylon (polypropylene) strap uncoiler	
	for HBG 80/1 and HBG 100/2
<b>Code No.</b>	<b>90221</b>

Nylon rope, diam. 8 mm	
	Tear resistance 1100 kg (2425 lb), 100 m (328 ft) coil
<b>Code No.</b>	<b>90203</b>

Nylon rope, diam. 10 mm (0.4 in)	
	Tear resistance 1700 kg (3747.8 lb), 100 m (328 ft) coil
<b>Code No.</b>	<b>90204</b>

Ratchet tensioner	
	Retrofitting on both models
<b>Code No.</b>	<b>90222</b>

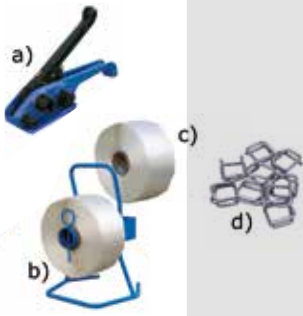
Wrapping set with polyester band	
	wrapping set includes: a) Band strapping machine (10-19 mm = 0.4 - 0.75 in) b) Portable uncoiler c) Polyester textile band (Width: 19 mm = 0.75 in, Length: 500 m = 1640.4 ft, tear resistance: 725 kg = 1598.3 lb) d) Box of steel buckles (1000 pcs). Buckles width: 19 mm (0.75 in)
<b>Code No.</b>	<b>90117</b>

Steel buckles width 19 mm (0.75 in), 1 box = 1000 pcs.	
	(1000 pcs). Buckles width: 19 mm (0.75 in)
<b>Code No.</b>	<b>90119</b>

Profi tensioner	
	10-19 mm
<b>Code No.</b>	<b>90116</b>



## Accessories for Pack-Systems

### S/I mesh bag with strap for Pack-System PS 1000



	1.000 l, 180 x 140 cm, 20 Pieces
<b>Code No.</b>	<b>91923</b>

### Mesh bag with strap for Pack-System PS 300



	60 l, 60 x 80 cm, 20 Pieces
<b>Code No.</b>	<b>91921</b>

### S/II mesh bag with strap for Pack-System PS 1000



	1.500 l, 225 x 140 cm, 20 Pieces
<b>Code No.</b>	<b>91924</b>

### Mesh bag with strap for Pack-System PS 300



	80 l, 60 x 100 cm, 20 Pieces
<b>Code No.</b>	<b>91922</b>



**Pack and store  
firewood!**

# Log grapples

• HVZ 1300



For more **ACCESSORIES**  
please see page 48

Log grapples for front loader with EC-Mount –for small timber contractors and tractor power from 30-60 kW.

- HVG 1300 grapples
- Universal joint
- 3.0 t (2.95 lt) rotator - 900 Nm
- Efficient and safe timber handling
- Modern proven technology
- Equipped with standard rotator
- Suitable for front loaders with only one double-acting control valve
- Optional safety skid
- Optional electric reversing valve (Code No. 96270)



Logging tongs	
Technical Data	<b>HVZ 1300</b>
Power	From the tractor hydraulics
Tractor power requirement	40 kW / 55 PS
Opening range	HG 1300 (90-1280 mm)
Clamping force	9,5 t
Weight without skid	approx. 230 kg (507 lb)
<b>Code No.</b>	<b>96243</b>

• HRZ Fix-Euro/Kombi

Combination log loader

Mounting to both front and rear loaders with 3-point hitch cat. II. Tractor power requirement 40 - 90 kW.

- Including HG 1300 grapples
- Universal joint
- Pivotal hanger for 160° grapple rotation.

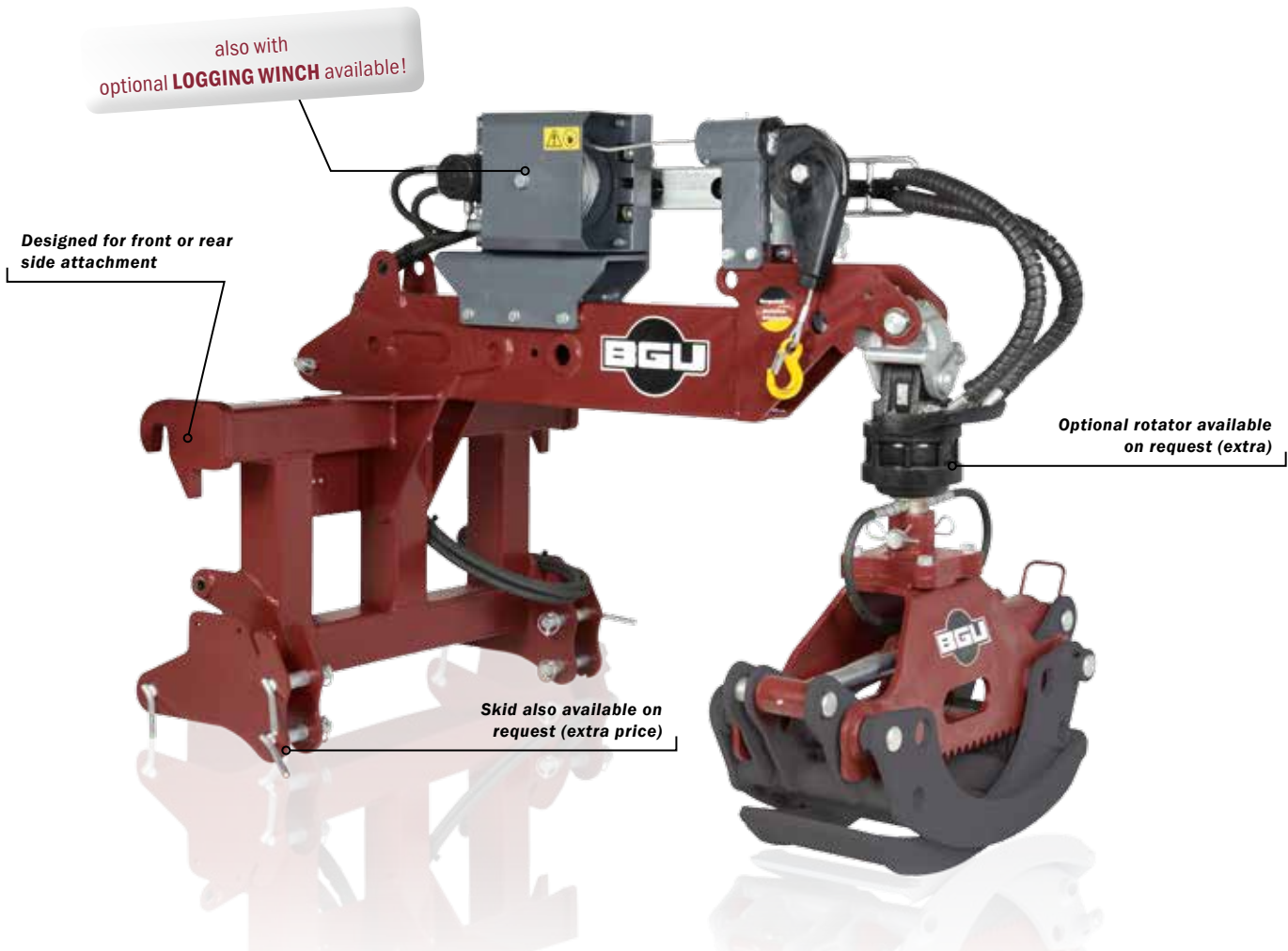

For tractor-controlled operation of the winch, a additional pressure and return line are needed. The figure shows an HRZ Fix-Euro/Kombi with optional rotor, 4.5 t (4.42 lt) (Code No. 96253) with hydraulic winch ASW 1850 F + remote control (Code No. 96370).

Attachments: (see page 48)

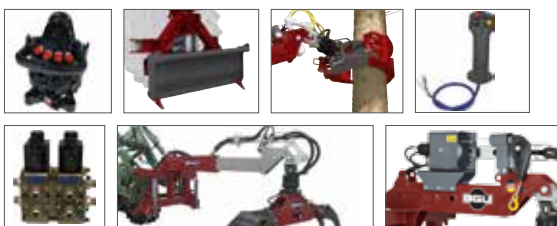

Log grapple	
Technical Data	<b>HRZ Fix-Euro/Kombi</b>
Power	From the tractor hydraulics
Tractor power requirement	40 kW / 55 PS
Opening range	HG 1300 (90-1280 mm)
Clamping force	9,5 t
Weight without skid	approx. 248 kg (546,7 lb)
<b>Code No.</b>	<b>96240</b>

# Log grapples

• HRZ Lader



*This very professional unit is complemented by an optional Hightech proportional control valve in 6 segment construction (3 proportional valves, 3 S-W and 1 floating) Code No. 96308*

*Optional with AS hydraulic extension arm.*

*Hydraulic top-swivel-grapples available on request (Extra)*

*Optional rotator available on request (extra)*

*with optional LOGGING WINCH available!*

*Skid available on request (Extra)*

Attachments: (see page 48)



**Combination unit - Handling and Loading**

Rear mount to 3-point hitch class II. Tractor power requirement 40 - 90 kW comprising:

- HG 1700 grapples
- 600 mm AS-Mechanical extension arm
- Hydraulic rotary actuator for 180° boom slewing, slewing force 12 t
- Lifting capacity: 12 t at approx 3500 mm boom reach.
- Moment: 1.8
- Universal joint
- Pivotal hanger for 160° grapple rotation.

Log grapple	
Technical Data	<b>HRZ Lader</b>
Power	From the tractor hydraulics
Tractor power requirement	40 kW / 55 PS
Opening range	HG 1700 (90-1680 mm)
Clamping force	9,5 t
Weight	approx. 395 kg (870 lb)
<b>Code No.</b>	<b>96250</b>

The figure shows an HRZ Log Loader with optional rotor, 4,5 t (Code No. 96255), hydraulic AS-Outreach (Code No. 96265), top swivel system (Code No. 96260) and 1500 mm skid (Code No. 96256), and proportional control valve (Code No. winch ASW 1850 F + remote control (Code No. 96365)

# Timber loader

• HRK



For more **ACCESSORIES**  
please see page 48

with optional **LOGGING WINCH** available!



It comes with own skid and wheel axle.



**Timber loader for rear attachment to a three-point hitch of a tractor hydraulics.** Suitable for diverse applications including tree felling, loading, and skidding. Attaches to the rear 3-point hitch Cat II of any tractor with power 45 to max. 90 kW.

- Including HG 1300 grapples
- Hydraulic rotary actuator for 180° boom slewing, slewing force 12 t
- Length of the articulated arm: 1500 mm - Max. capacity at 1.8 m reach: 950 kg and 450 kg (including grapple) at 3.8 m.
- Universal joint
- AS - 1100 mm hydraulic extension arm
- Rotator - 1400 Nm, 4.5 t at 195 bar
- Complete with skid, and axle with 2200 mm wheel base and 260/70-15.3" tires
- **Incl. Grapple - Top swivel system (Code No. 96260) and ergonomic control station (Code No. 96301)**

Equipped with standard rotator

The picture shows a HRK with optional winch ASW 1850 F + remote radio control (Code No. 96360) and ergonomic control station (Code No. 96301).

Timber loader	
Technical Data	<b>HRK</b>
Power	From the tractor hydraulics
Tractor power requirement	45 kW / 62 PS
Opening range	HG 1300 (90-1280 mm)
Clamping force	9,5 t
Weight	approx. 850 kg (1874 lb)
<b>Code No.</b>	<b>96300</b>

# Modular Logging System



Timber loader with attached PTO logging winch.



Hydraulic top-swivel-grapples

## The perfect logger kit:



### Hydraulic winch ASW 1850 F



with idle, 1850 kg pull force, 30 m wire rope length, and Ø 8 mm

Remote operation through a 3-channel radio control, including solenoid valve, a receiver, a pocket-sender with belt clip

adapter and wire rope pulley

Retro-fitting to all BGU loaders from the year 2013 onwards

<b>Code No.</b>	<b>96370</b>
-----------------	--------------

<b>Code No.</b>	<b>96365</b>
-----------------	--------------

<b>Code No.</b>	<b>96360</b>
-----------------	--------------

## Vertility and efficacy for all logging contractors

Timber grapples and loaders feature a very rugged construction for superior performance even for demanding applications.

Special, modular construction system fitting individual retrofitting requirements make our equipment outright incomparable for a vast number of possible applications matching all needs of forestry and logging contractors.



*The modular system conception ensures top performances and nearly universal use.*



# Optional tools and attachments



Model selection	Wheel axle	Rotator 4,5 t	Rotator 4,5 t
Choose the right accessories for the models below.	comprising 2 axle mounts with wheels for bolting on the skid. Wheel base: 2200 mm Tires: 260/70 ~-1/-15.3"	1400 Nm, 4.5 t at 195 bar, Flange 140x140 4xM16 Weight: 25 kg. (55 lb) Recommended for swivelling grapples (also available lose with set of hoses)	1200 Nm, 4.5 t at 230 bar, Flange 140 x 140 4 x M16 Weight: 22 kg (49 lb) 25 bores
HVZ 1300			
HRZ Fix-EZ		•	•
HRZ Fix-Euro/Kombi		•	•
HRZ Lader	•	•	•
HRK	✓	✓	
<b>Code No.</b>	<b>96251</b>	<b>96255</b>	<b>96278</b>

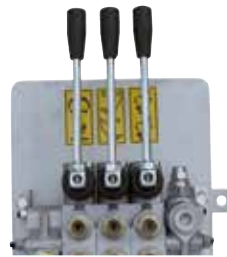

Model selection	Skid upper pin unit	Hydraulic control valve, 3 segment construction	Hydraulic control valve, 4 segment construction
Choose the right accessories for the models below.	for front and rear skids	Section construction, single joystick	Section construction, single joystick
HVZ 1300			
HRZ Fix-EZ		•	
HRZ Fix-Euro/Kombi	•	•	•
HRZ Lader	•	•	•
HRK	•		
<b>Code No.</b>	<b>96257</b>	<b>96262</b>	<b>96263</b>



- Possible expansion
- ✓ Adjustable log stop



Rotator 3,0 t	Skid 1500 mm (60 in)	Front skid	AS hydraulic extension arm
900 Nm, 3.0 t at 200 bar, endless, Shaft Ø 49.5 mm (19.5 in), weight: 18 kg (39 lb), Suitable for small grapples and log loaders. 25 bores	userfriendly installation 1500 mm (60 in), 2 backhoe teeth	user-friendly installation; skid width 1025 mm (41 in); Weight: 52 kg (115 lb)	600 mm only possible with initial fitting-out
✓	• • ✓	•	• • ✓
<b>96277</b>	<b>96256</b>	<b>96288</b>	<b>96265</b>



Hydraulic control valve, 5 segment construction	Hydraulic control valve, 6 segment construction
Section construction, single joystick	Section construction, single joystick
•	•
<b>96264</b>	<b>96268</b>

# Optional tools and attachments



Model selection	AS-Extension arm 600 mm	Joystick-operated machines	Proportional control valve
Choose the right accessories for the models below.	Mechanical (Delivery time: 3-4 weeks from confirmed purchase order) Strictly possible for HRZ Fix-Euro/ Kombi only possible with initial fitting-out	Radio controllable functions: Rotator left/right, grapple open/ close Retro-fitting on prior purchases for use as control lever of the front loader	in 6 segment construction (3 pro- portional valves, 3 S-W and 1 flo- ating), completely pre-assembled ready for use and controllable with multifunctional control joystick (for all functions in one lever).
HVZ 1300		•	
HRZ Fix-EZ			
HRZ Fix-Euro/Kombi	•	•	
HRZ Lader	✓		•
HRK			
<b>Code No.</b>	<b>96242</b>	<b>96275</b>	<b>96308</b>



Model selection	Grapple - Top swivel system	Switching valve with two operating power supplies	Reversing control valve with three functions
Choose the right accessories for the models below.	Hydraulic Operation 180° rotation range only possible with initial fitting-out	Electromagnetic 12 V- Electric power	Electromagnetic 12 V- Electric power
HVZ 1300		•	
HRZ Fix-EZ	•	•	
HRZ Fix-Euro/Kombi	•	•	•
HRZ Lader	•		
HRK	✓		
<b>Code No.</b>	<b>96260</b>	<b>96270</b>	<b>96271</b>

- Possible expansion
- ✓ Adjustable log stop



Proportional control valve	HVG 1300	HG 1300	HG 1700
in 7 segment construction (4 proportional valves, 3 S-W and 1 floating), completely pre-assembled ready for use and controllable with multifunctional control joystick (for all functions in one lever).	Opening range: 90-1280 mm, Clamping force 9,5 t, Weight: 100 kg	Opening range: 90-1280 mm, Clamping force 9,5 t, Weight: 118 kg	Opening range: 90-1680 mm, Clamping force 9,5 t, Weight: 148 kg
	✓		
		•	✓
		✓	•
		•	✓
•		✓	•
<b>96309</b>	<b>96315</b>	<b>96314</b>	<b>96316</b>

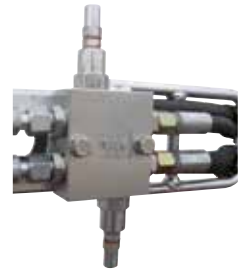

Hydraulic winch ASW 1850 F			Directional slide valve
with idle, pull force 1850 kg (4079 lb), 30 m (98 ft) wire rope length and Ø 8 mm. Remote operation through a 3-channel radio control, including solenoid valve, a receiver, a pocket-sender with belt clip, adapter and guide roll for pull rope. Retro-fitting is possible on all BGM timber grapples from the year 2013 onwards.			mandatory for use with hydraulic top-swivel-grapples
•			•
	•		•
		•	•
<b>96370</b>	<b>96365</b>	<b>96360</b>	<b>96273</b>

# Metal band grinders

- MBS 751
- MBS 1501

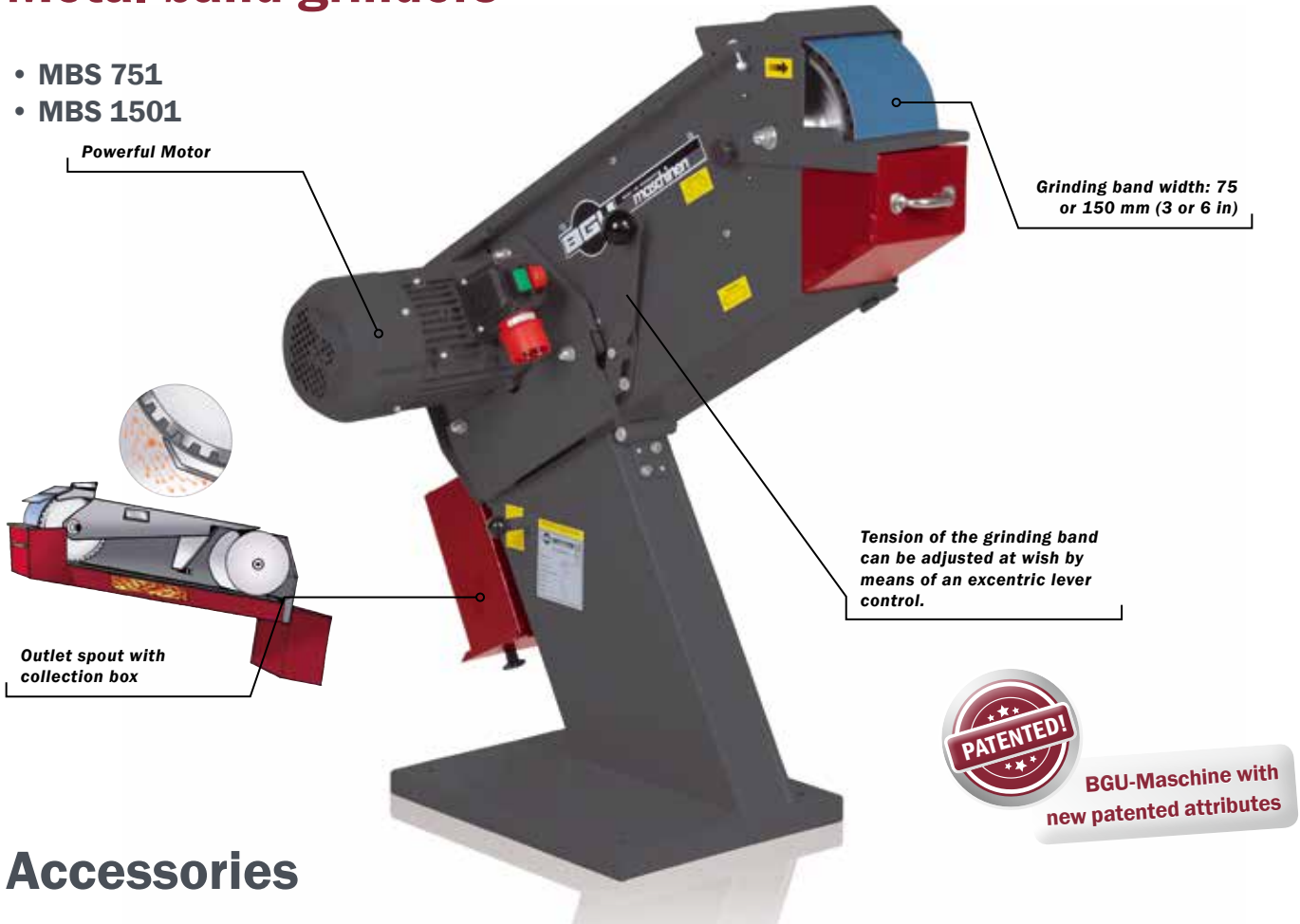

## Accessories

Spare band 2000 x 75 mm		Spare band 2000 x 150 mm	
-------------------------	--	--------------------------	--

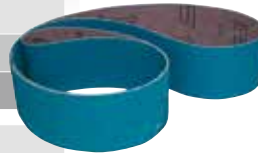

	Grit size 40
<b>Code No.</b>	<b>90552</b>
	Grit size 60
<b>Code No.</b>	<b>90553</b>
	Grit size 80
<b>Code No.</b>	<b>90554</b>
	Grit size 100
<b>Code No.</b>	<b>90555</b>

	Grit size 40
<b>Code No.</b>	<b>90562</b>
	Grit size 60
<b>Code No.</b>	<b>90563</b>
	Grit size 80
<b>Code No.</b>	<b>90564</b>
	Grit size 100
<b>Code No.</b>	<b>90565</b>

Adapter for dust extractor MBS 751	
------------------------------------	--



	for hose Ø 100 mm
<b>Code No.</b>	<b>90551</b>

Adapter for dust extractor MBS 1501	
-------------------------------------	--



	for hose Ø 100 mm
<b>Code No.</b>	<b>90561</b>

## Metal band grinder for the industry and crafters

A 250 mm (10 in) large diam, serrated contact wheel combined to a really powerful motor provide for excellent grinding quality and performance.

Powerful material intake and a belt speed of 37 m/s (122 ft/sec) assure a very efficient performance and excellent finish.

- Quick changing and setting from horizontal to angled belt position
- Vibration free, smooth running
- Solid work table for end-feed grinding
- Belt speed of 37 m/s (122 ft/sec) ensuring a very efficient performance and excellent finish.
- Efficient material removal for more production economies
- 250 mm (10 in) large contact wheel
- Dust and chips outlet to collector box
- Dust disposal in a special metal box collector



**Thanks to a solid work table it is possible to accommodate (in horizontal position) longer workpieces for end-feed grinding.**



**Band tracking is very quickly done with no need of ancillary tools or instruments by just turning the special black knob on one side of the contact wheel (Patent no. 4131523).**



**An outlet spout beneath the entire grinding band length ensures efficient removal of dust and chips that are safely disposed inside the special in-built box. Patent Nr. 0399155.**

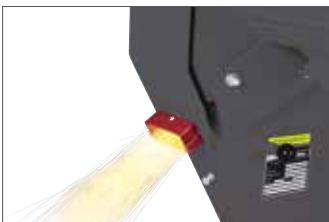

**Grinding dust, chips and sparks caused by contact wheel revolutions are efficiently and safely cleared away from the work area through the spout.**

Metal band grinders		
Technical Data	MBS 751	MBS 1501
Power / motor	Electric, 400 V 16 A EC plug	Electric, 400 V, 16 A EC plug
Rated power	4,0 kW P <sub>2</sub>	4,0 kW P <sub>2</sub>
Band size	75 x 2000 mm	150 x 2000 mm
Contact wheel	250 x 75 mm	250 x 150 mm
Band speed	37 m/s	37 m/s
Horizontal work table	75 mm continuous	150 mm continuous
Weight	approx. 96 kg (211 lb)	approx. 114 kg (251 lb)
<b>Code No.</b>	<b>90550</b>	<b>90560</b>

# Press drill

- SB 320 SH/1

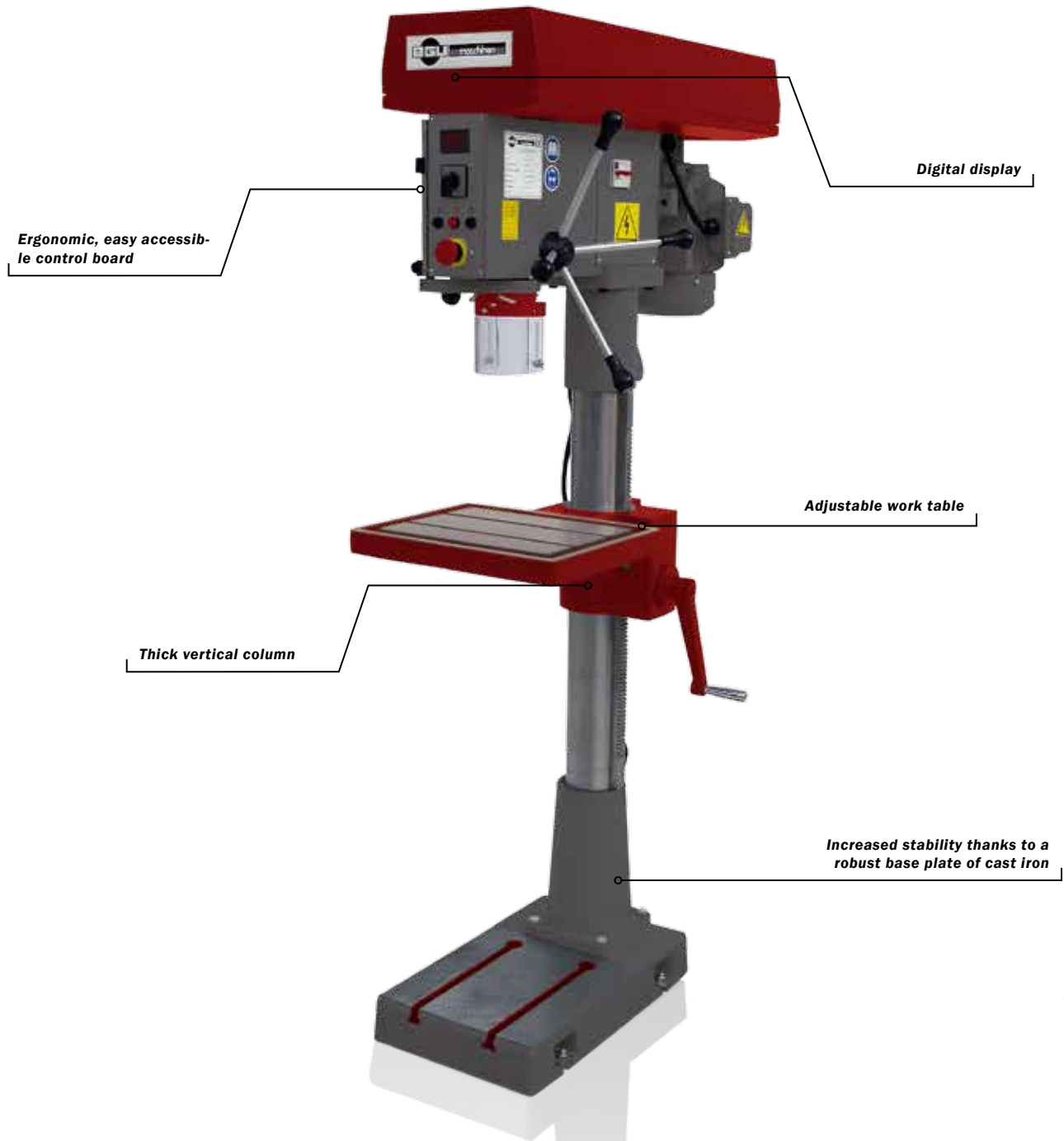

## Accessories

### Quick-action vice



**Code No.**

revolving over 360° with hardened steel jaws. Jaw width 120 mm (4.7 in)

**90499**

### 400 mm (16 in) cross sliding table with clamping tabletop



**Code No.**

300mm (12 in) longitudinal and 150 mm (6 in) transverse displacement Rugged cross slide vice with adjustable dovetail ways.

**90497**

## Economy through modern technology

- Heavy-duty pole diameter: 100 mm (4 in)
- Increased stability thanks to a robust base plate of cast iron
- Head tilts right and left (for cutting threads)
- Suitable for a wide drilling range up to 31.5 mm (1.25 in) wide holes with changer for speed variation (stepless adjustment of the spindle speed)
- Accurate and robust spindle seating to allow use of different milling/facing attachments (accessories)
- Ergonomic, easy accessible control board
- with LED lighting



Digitally display of rotation count



### Press drill

Technical Data	SB 320 SH/1
Power / motor	Electric, 400 V, 16 A EC plug
Rated power	1,3 kW P <sub>1</sub>
Drilling capacity on solid material	27 mm
Tool holder	MK 3
Runout	230 mm
Spindle stroke	130 mm
Spindle height	min. 150 mm
Spindle height above table	max. 750 mm
Spindle speed	approx. 100-1600 Rpm
Table size	400 x 320 mm
Base plate	380 x 540 mm
Dimensions (W x L x H)	650 x 840 x 1720 mm
Weight	approx. 320 kg
<b>Code No.</b>	<b>90488</b>

## Metal bandsaws

- BSM 190 G



Quick clamping chuck with round bar guides. Clamping by means of eccentric lever.



## Powerful machines for trade, craft, industry and private use

- Automatic blade shut-off at the end of cut
- Standard radiator
- Standard millimetre cut-length stop and clamping arrangement
- Quick clamp vice
- Fitted with oil-bath planetary gear box for quiet, smooth operation
- Ergonomic floor base with worktable at 720 mm (28.3 in)
- Infinite adjustment of the mitre cut angle
- Large cutting capacity even for acute angles up to 60°
- Band tension and blade break-in safety (control system)

## Accessories

Metal bandsaw	
Technical Data	<b>BSM 190 G</b>
Power / motor	Electric 0,85/1,2 kW P <sub>2</sub>
Rated power	400 V 16 A EC plug
Cutting speed	35 / 70 m/min.
Saw band	2480 x 0,9 x 20 mm
Dimensions (W x L x H)	1200 x 700 x 1200 mm
Weight	approx. 201 kg (443 lb)

<b>Code No.</b>	<b>90716</b>
-----------------	--------------

Cutting range BSM 190 G (mm)					
↘	●	■	▬	▬	
<b>90°</b>	190	190 x 190	230 x 170	220 x 190	
<b>45°</b>	155	155 x 155	155 x 155	155 x 155	
<b>60°</b>	110	70 x 70	115 x 70	115 x 70	

Replacement belt BSM 190 G	
	Please mind for tooth pitch! Vario M 42 2480 x 0,9 x 20 mm
	<b>Code No.</b> <b>90718</b>

Replacement belt BSM 190 G	
	Please mind for tooth pitch! Vario M 42 2480 x 0,9 x 20 mm
	<b>Code No.</b> <b>90717</b>



• **BSM 231/1 DG**



Mitre cuts are accurately adjustable at 90°, 45° and 60°.



- Automatic blade shut-off at the end of cut
- Standard radiator
- Standard millimetre cut-length stop and clamping arrangement
- Semi-automatic mitring 60° left and 45° right
- Swivelling cutting head
- Feed pressure adjustment by means of a hydraulic down-feed cylinder
- Widia band guide
- Automatic chips removal
- Quick clamp vice moving to the left and the right.

Material	Tooth pitch	Material	Tooth pitch
<b>s (mm)</b>	ZpZ	<b>s (mm)</b>	ZpZ
<b>1 - 2</b>	10/14	<b>bis 20</b>	6/10
<b>2 - 4</b>	8/12	<b>20 - 40</b>	5/8
<b>4 - 8</b>	6/10	<b>40 - 80</b>	4/6
<b>8 - 12</b>	5/8	<b>80 - 230</b>	3
<b>over 12</b>	4/6	Take special care while choosing the right pitch of teeth.	

## Accessories

Replacement belt BSM 231 all types	
	Please mind for tooth pitch! Vario Matrix 2 2710 x 0,9 x 27 mm
	Tooth pitch 3 K
<b>Code No.</b>	<b>90704/1</b>
	Tooth pitch 4-6
<b>Code No.</b>	<b>90705/1</b>
	Tooth pitch 8-12
<b>Code No.</b>	<b>90706/1</b>

Replacement belt BSM 231 all types	
	Please mind for tooth pitch! Vario Matrix 2 2730 x 0,9 x 27 mm
	Tooth pitch 3 K
<b>Code No.</b>	<b>90704</b>
	Tooth pitch 4-6
<b>Code No.</b>	<b>90705</b>
	Tooth pitch 8-12
<b>Code No.</b>	<b>90706</b>

Metal bandsaw	
Technical Data	<b>BSM 231/1 DG</b>
Power / motor	Electric 0,85/1,2 kW P <sub>2</sub>
Rated power	400 V 16 A EC plug
Cutting speed	28 / 56 m/min.
Saw band	2730 x 0,9 x 27 mm
Dimensions (W x L x H)	1555 x 1400 x 1250 mm
Weight	approx. 330 kg (727 lb)
<b>Code No.</b>	<b>90724</b>

Cutting range BSM 231 DG (mm)				
<b>90°</b>	225	225 x 225	•	300 x 200
<b>45° R</b>	210	200 x 200	•	200 x 200
<b>45° L</b>	170	150 x 150	•	200 x 80
<b>60°</b>	120	120 x 120	•	120 x 130

# General Sales Conditions

## General sale conditions (hereinafter AGB) of SÜMA Maschinengesellschaft GmbH

### 1. Introduction

Our general sale conditions apply to all contracts, deliveries and miscellaneous agreements between us and any third parties, now and in the future. The contents of our order confirmations will be deemed as tacitly approved by the reference partner as well as these General Sale Conditions or any other statement of acceptance, unless a written claim is raised against all or parts of the order confirmation and served at our offices within one week from the confirmation date (date of the Post Office stamp). All contracts are meant as validly enforced from the date of sending of our written order confirmation.

Eventual purchase terms and conditions of our buyers and business partners will be deemed as binding on us, strictly if specifically accepted and attached in writing to the reference contract. Our general sale conditions are, therefore, binding and fully in place starting as of the shipment or order confirmation date.

In case of discrepancies between our general sale conditions and those of the reference partners, our AGB will prevail even in the absence of our previous and explicit rejection of said discrepant terms.

Moreover, we reserve ourselves the right of any technical innovation, change or improvement in the construction, size, weight, material and design of our products even without prior notice. The same applies also to the contents of our sale literature, including brochures and catalogues. The foregoing changes and modifications may eventually take place, if required, even after the sending of our order confirmation.

For materials, products, construction/engineering/design data, samples, capacities, pictures and any other product-related literature we reserve ourselves all industrial and intellectual property as well as copyright and ownership rights. The foregoing literature may not be reproduced or released to thirds without our express consent.

**2.** Our partners are to explicitly commit to treat as strictly confidential all information brought to their understanding during the regular business relationship with us and is beyond the scope of the normal commercial and technical information that is already of public domain.

**3.** Our order confirmation is the only document applicable for quantity and description of a shipment. Any shipment-related claim should be placed by the customer in writing latest within 8 working days after the date of the reference shipment document. Later claims will be disregarded in spite of any other written provisions of ours stating any eventually different arrangement.

Eventual other statements or allowances made by our sale representative are always subject to our written confirmation for validity. In the event of any infringement of a sale contract, we are entitled to claim for the damage/loss incurred to us by recovering the order value either in full or in part.

In the latter case, we shall recover 25% of the sale price, however without any obligation to submit evidence of the loss incurred and even if the defaulting party provided written evidence of any smaller loss.

**4.** Unless differently provided for in the contract, our prices are all meant ex-works excluded packing, freight and custom clearance. All prices are subject to additional application of the VAT at the applicable rate at the time of invoicing. Packaging is charged at cost price. No packaging returns are accepted.

**5.** Payments of our orders are to be executed within one month from the date of the invoice. Invoices are deemed as successfully sent against our internal evidence/receipt of a sent invoice plus two work days. Eventual term-based discounts must be shown on the invoice. Discounts for special payment terms are computed on the net order value, and can be strictly granted to customers having no outstanding credit with us.

All payments must be transferred to us as the only beneficiary allowed. Any amount paid to the sales representatives without our written collection mandate shall not release the payer from his payment obligations to us. Payments from our contract partners are deemed as fully executed strictly on the crediting of the entire invoice amount to our bank account.

Settlement of invoices by bank cheques and/or drafts shall only be accepted on account of payment. Bills of exchange will be strictly accepted for payment only and only if bankable and with the charging of all bank charges related to the discounting of the bills or protesting of a cheque dishonoured for a reason, which will always be paid in cash and immediately.

In the event of a late payment, we are entitled to the application of interest charges at the current bank rate and no less than 3% of the actual discount rate of the Deutsche Bank, and this without any need of a formal previous notice of late-payment default.

The purchase price becomes due forthwith irrespective of the term of any bills of exchange taken on deposit, in the following events:

- a) The starting of a seizure proceeding against the reference customer, a major payment delay by the latter, or the receipt of a bad rating about him;
- b) The customer transfers or pledges any asset or goods that are actually under a reserved-property arrangement with us.

To any of the foregoing events, all outstanding (even not yet due) amounts will become due at once whilst pending shipments will be strictly released against advanced payment in cash. Moreover, these occurrences, we will immediately trigger our right to request an efficient guarantee for our credits. This includes our right to terminate the contract after an adequate notice time and/or to claim for damages resulting from contract infringement. At the same time, we will be entitled to forbid the defaulting partner to stop transferring in whatsoever way the goods, we delivered with a retained-property clause and request the immediate recovery of any transferred property. In the event we accepted a return of the goods, our right of contract termination will be strictly and validly enforced by our written request to do so. All costs for the returning of the goods will be in charge of the defaulting contract party.

**6.** Delivery terms and conditions as well as lead times are always accounted ex-works. Delivery terms and time that was mentioned, but not confirmed in writing by us, will be binding on us in any case.

Delivery terms as well as any other delivery time granted, will be strictly accounted from the successful receipt of all export documents to be supplied by the customer.

A delivery term is considered as fully met as of the date of the collection notice sent, even if the goods could not be picked up on time and for any reason not directly related to us.

We are not liable for shipment delays due to late or deferred deliveries of our sub-suppliers.

Our delivery terms will automatically extend by an equal amount time as taken by the customer to fulfil his obligations in terms, for example, Of handing over to us the required delivery documents. A late-delivery fault of ours will only occur when the deadline is past and we failed to react within the new deadline stated in the written reminder of our customer and this without any good reason of ours. Should any loss or damage be incurred by our customer as a result of our failure to provide on-time delivery as mentioned before, our customer will be entitled to claim for a late-delivery penalty in the amount of the loss actually suffered by him and to be proven to us by means of written evidence and with the exclusion of all further claims.

**7.** If any unpredictable event occurs (i.e. Major force, strikes, production discontinuance, lack of raw materials, wars, embargoes, state bans and any other such condition impairing our delivery service) that is not resulting from a fault of ours, we will no longer be bound by our delivery obligations for the time of lasting of the event. Major force events include, for instance import/export bans, fire, shortage of fuels or energy supplies, barricades, riots and any other similar situations that are not controlled by or due to us.

Should the reference delivery and/or service be fully or partly made impossible, or unlikely to be executed, we will be released from all our shipment obligations.

**8.** Basically, we do not perform any assembly service of the goods delivered to any destination or place of use. However, we are available to do so and send our skilled installers against a formal written request of the customers, who will be charged for the cost of this extra service. Our staff, assigned to any installation service on customers' request, will be treated on site as own staff or helpers of the party having requested them. Our contract partners are not entitled to assign our assembly/installation personnel to other works that are beyond the scope of the original assembly request.

**9.** The type of shipment and transport vehicles are strictly selected by us, unless other special agreements are taken by the parties in writing. Goods that we notify as ready for collection, must be collected promptly and in no case later than 8 days after the date of notification. Alternatively, we may decide at our own discretion to ship the goods by any means as we may deem as most appropriate.

If the pick-up or collection of the goods is delayed for any reason beyond our control, we are entitled (but not obliged) to store or let someone for us store the reference goods and charge all costs and risks related to this operation to the defaulting contract partner.

In this case, we will decide at our own discretion on how to store the delayed goods and carry no liability for the latter during storage.

Moreover, we will be entitled to take all measures that we may deem as most appropriate to properly maintain them as if they had been shipped. This is also the case of partial shipments or deliveries of other services of ours as for instance, freight, carriage, and assembly/installation.

Although we always put our best endeavours for the complete shipment of each order in one lot, we are entitled to eventually arrange partial shipments if acceptable for the customer. In this case, each partial shipment will account as an independent case. Unloading of the goods at destination is entirely up to the customer who shall also bear all costs incurred.

**10.** Customers can rely on written representations concerning the quality of the goods, only if any such representations were officially made to them in writing and expressly handed over to them in their name.

Customers using our products for any special application of their own, are supposed and obliged to check on their own the suitability of the products for such applications. Customers are to inform us in writing and in advance about any special application requirement and eventually they are to notify us the outcome of their trials and tests carried out with our products.

An assessment of the goods quality will be done on the status of the goods on the day of leaving our premises. Customers are to inspect the machines and products immediately as they are received and unloaded.

Claims must be notified to us in writing by and within 8 days from the day of handing-over at destination. This applies to any claim, including external flaws and defects detected during the first visual control of the complete lot delivered. Eventual transport damages must be notified to the driver in writing by adding a note of conditional acceptance on the delivery bill and taking care of giving a copy of this bill to the driver and sending another copy to us along with their claim. Failure of the customer to submit extensive evidence, we will not accept any claim for any damage or loss whatsoever.

Moreover, customers are to settle eventual transport damages directly with our insurance company to whom we will send due written report of the event occurred and for which a reimbursement was claimed.

Any other claim related to problems and defects that could not possibly be detected at first, even most accurate inspection, are to be reported in writing to us immediately on the date of the findings, making sure to fully describe the event, the consequent claim and the exact time of the occurrence.

**11.** Any such claim is subject to a limitation period of one month at the latest after the written refusal of the claim by us. Warranty claims of the customers are not valid for goods that have been mishandled, reprocessed or changed/reworked by other third without our prior permission.

The warranty validity period starts on the date of invoicing and no earlier of the date of the property risks transferred to the customer. Repairs and replacements will not reset the warranty period that will continue over the remaining original time.

Defective goods or the missing of any quality feature ensured by us will receive 6-month warranty. The warranty period for replacement goods and improvement works is also of 6 months, but at least until the elapsing of the original warranty for goods delivered.

For outsourced, third-party products, our liability shall be limited to the further assignment of liability claims to the supplier of the third-party product. We undertake to supply our customers all information needed for the follow-up of their claims and especially eventual documentary evidence, if available. Of course, this provision does not refer to cases in which the claim is due to a fault of ourselves.

Our warranty obligations are conditioned by the utmost compliance of the customer with our user's manuals, installation guides and other general specifications and recommendations concerning setup and use of our products. We will no longer be bound by our warranty commitments, if a written claim raised on us relates to a faulty or unauthorized change,

reworking or use of the products. We will accept no warranty claims and no liability for damages resulting from normal or use-related machine wear, excessive stress, improper maintenance, acts of vandalism, non-compliance with our user's manuals, misuse or faulty operation.

We will not accept any liability for faults and problems caused to our products by modifications or alterations of any person other than our authorized service dealers and staff. Our warranty strictly covers those products and parts thereof, that show a clearly evidenced material or production defect. The warranty service is moreover strictly limited to the free-of-charge replacement or repair of the defective item. Alternatively, we may decide to reimburse the value of the degraded price. We will accept no other obligation on us than the mere replacement or repair of the defective parts. Handling and freight costs will not be reimbursed.

Customers are to allow access to the site of defective goods, so that either the manufacturer or his representatives may inspect and survey the reference material claimed. In order for us to undertake the repairs or replacements which appear to be necessary at our sole discretion, customers are to allow in their claim a sufficient time and opportunity.

In order for us to undertake the repairs or replacements which appear to be necessary at our sole discretion, customers are to allow in their claim a sufficient time and opportunity. During our service interventions we are allowed to ask and customer are to provide adequate help as required. Customers may refuse to accept or decide to degrade the goods claimed and ask for compensation, if it was not possible to remove the problems claimed, or if the problems claimed remained even after our second intervention, or second parts supply, or any additional intervention of any other skilled labour appointed by any of the parties, providing that the term offered by the customer for successful remedy has been exceeded.

Customers are only entitled to receive a damage compensation in the case of premeditation or gross negligence of ours. We are not liable for any damage that is not strictly and directly related to goods shipped.

This is also true for eventual consequential damage of any kind and nature, as long as not due to premeditation or gross negligence of ours and providing that our quality warrant does not include a consequential-damages clause.

Unless different written provisions, the warranty does not cover customers' claims related to product defects that result from improper handling, infringement of our specifications and other contract conditions, providing that no premeditation and gross negligence is evidenced on our account. Similarly, we will not respond to claims placed by customers after the warranty validity period or for failure of compliance with the written form obligation. No further claims will be accepted for outsourced items, and especially claims due to production faults for which the original manufacturer is solely liable. However, we will transfer customers our rights against the reference manufacturer or sub-supplier providing that customers submit us a formal written request. Our effective disclaimer includes a waiver of liability on account of all our employees, service and installation staff.

**12.** All goods delivered will remain our sole property up to successful settlement of the complete payment. Our retained property right will remain validly in force until complete settlement of payment as well as eventual other receivables of ours from the customer. Customers are not allowed to integrate the goods with/on other items or transform them into other products subject to any right whatsoever of other thirds (i.e. collateral assignment, liens etc...). Should our goods be integrated/transformed with/into a different item, we will automatically gain co-property right of the new item obtained from our product.

The extent of this right will be based on the ratio between the purchase price of our product and the value of the new item. Customers are to keep and maintain the new item on our behalf without any remuneration. Customers may transfer the goods delivered with a retained property clause in the course of their normal business, providing that they have not previously assigned their rights to other thirds, or that these rights are not encumbered in any other way. In this case, customers assign us all claims arising from the sale of retained items in order to secure our credits. If our claims arising from the sale of retained items collide with similar rights of other suppliers, we will acquire a co-title thereto in the same proportion as aforesaid co-property right. Customers shall be obliged to keep the proceeds from sales subject to retention of title in a separate deposit and strictly use these proceeds for the settlement of our outstanding credits. Should the value of securities exceed our credits by more than 20%, we will release the balance of the secured amounts against a written request of the customer to do so.

In case of a payment delay by the customer, all other outstanding payments will become due at once. We are entitled to forbid the customers any further reworking of the products in combination with other items and especially the sale of retained-property goods. Moreover, we are entitled to retrieve eventual retained-property goods. Customers have insofar no right of possession in the retained property goods. On our request, customers are to promptly inform us the date when retained-property goods were sold and the name/details of the buyer.

**13.** Basically, we will not accept the return of any goods that were regularly ordered and supplied by us without defects. Should any extraordinary situation lead us to decide to accept a return from a customer, we will only pay 80% back of the net invoice amount less any outlay or expenditure for freight, transport damages etc...

**14.** Should any contract clause become partly or fully invalid or no longer applicable, this will not affect the validity of the remaining parts of the contract between us and the customer that will remain fully in place. The parties agree to replace any such invalid or not enforceable clauses by other provisions that may better match their requirements and the purpose of the contract.

**15.** All contract relationships between us and our customers are strictly subject to the German Law, with express waiver of the United Nations Convention on Contracts for the International Sale of Goods.

**16.** The parties agree that all rights and obligations (payment and delivery) under this contract shall be deemed as executed at the place of our premises in 99734 Nordhausen, unless other written provisions apply. The exclusive local place of jurisdiction for any disputes under this Contract shall be the Court of the Nordhausen, Germany. However, we reserve ourselves the right to conduct legal proceeding against our partners at their jurisdictions.

**17.** In the framework of, or in connection with our business operations, we will collect data on our partners and process them in accordance with the German privacy rules, regardless of whether the data were supplied by our partners or other thirds.



**SÜMA Maschinengesellschaft GmbH**

Helmestraße 94 · 99734 Nordhausen/Harz  
info@bgu-maschinen.de

**Our offices are opened:**

**Mondays through Thursdays** from 8 am to 5:30 pm  
**Fridays** from 8 am to 4 pm

**Contact:**

**Receptionist** Phone: +49 3631 6297-0  
Fax: +49 3631 6297-111



**SÜMA**  
BGU MASCHINEN

**YOUR DISTRIBUTOR**

