

schepach
Workshop

Edition 2006

saws · planes · moulds · sands · turns · glues · drills · vacuums

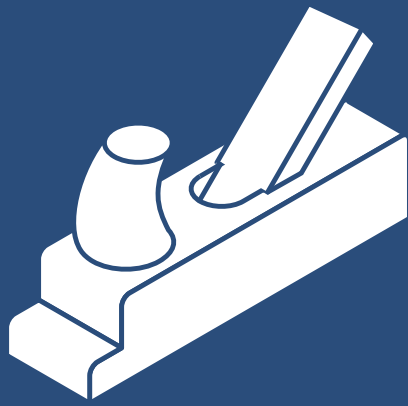

The best machines in your workshop are the result of the highest technology in our “workshop”.

scheppach is Europe's most innovative producer of wood-working machines, having introduced around eighty new models since 1997.

For more than 70 years our designers, technicians and engineers have thought about “tomorrow” so that scheppach is always that one step ahead of our competitors. That is what makes the difference when you buy scheppach. We call it progressive forethought. Following the introduction of our Quality Management System our standard of technology is confirmed with Certification DIN EN ISO 9001.

The foundation of our new product development derives from the demands of our customers, which we convert – after careful research – into reality in a record time of four to six months. Because we listen to what our customers tell us, and combine their input with our own expertise, scheppach machines are noted for incorporating all those finer details which generally do not come in a standard specification. Inspect our machines closely and you will immediately recognise scheppach quality.

You will always find scheppach at the forefront of new innovations because our customers are always in the forefront of our future developments.

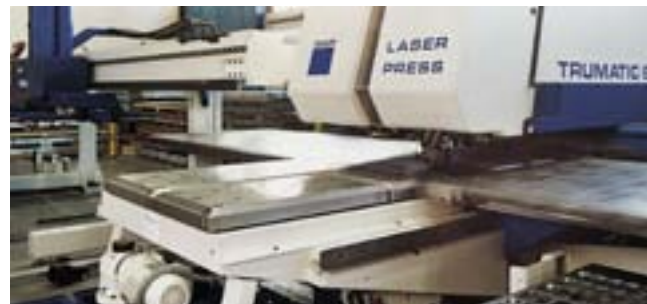

Above: Computer Assisted Design (CAD) is implemented from the creation phase to the final production. Construction designers work flexibly with several screens enabling all expectations to be completed with maximum efficiency.

Below: The Laser tooling cuts the most complicated forms to exact standards and most economically.

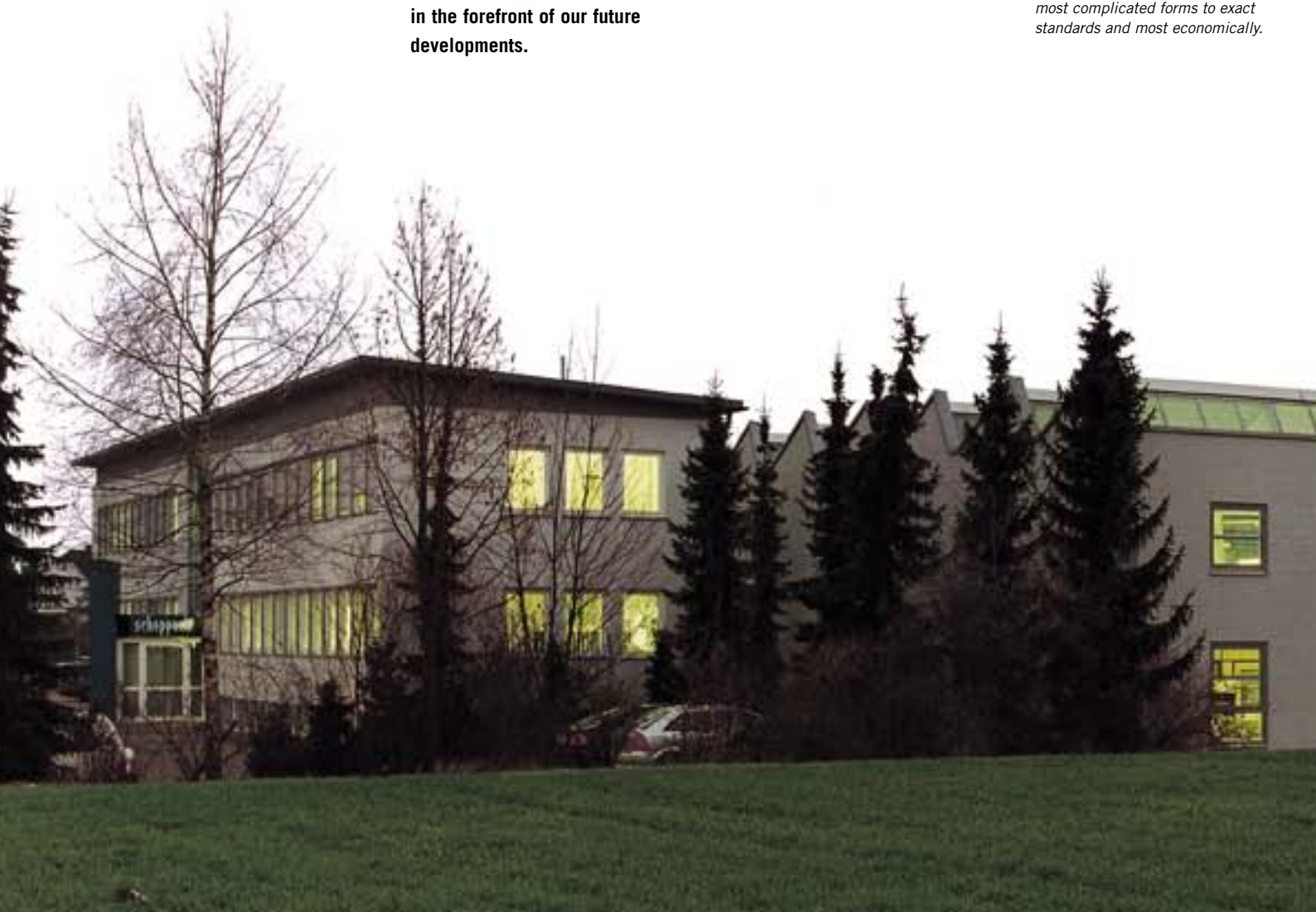

POWDER COATED



Metal fabrication is completed by a robotic welder. The robot's particular talent is repeated precision. When instructed correctly it never makes an error.

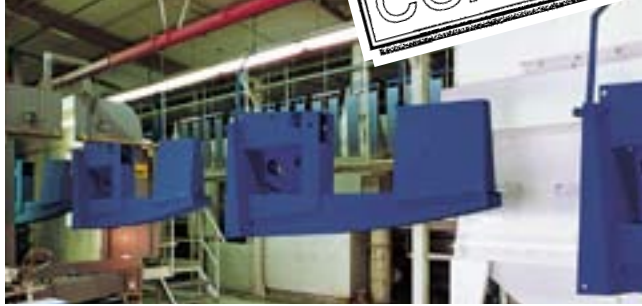

Above: scheppach Powder Coating installation uses 12 nozzles. colour can be changed within 15 minutes. The highest quality finish is guaranteed. A finish that lasts a lifetime.

Below: Highly trained engineers are involved from the initial construction to the final assembly. Here Forsato Panel Saws receive final commissioning.



Above: scheppach Basato bandsaws have achieved design awards. These awards can only be achieved through the integration of man's ingenuity and expertise, together with the latest manufacturing technology.



Below: hms 260 planer assembly line. Each machine has its own highly trained and motivated work team. scheppach quality never comes by chance.





Quality, safety, and environmental compatibility on all scheppach products comes with the following seals of approval.

- *GS "Geprüfte Sicherheit"* stands for "proven safety" by the highly respected German Trade Association.
- *GS "Sawdust tested"* stands for "wood dust tested" so that with the respective scheppach extractor, the unit allows no more than 2 mg/m³ back into circulation.
- *H2* is certification that dust emission from a scheppach extractor is under 0.2 mg/m³.
- *CE* signifies that the machine passes all the relevant fundamental Health and Safety requirements and also meet the electrical safety regulations.
- *DIN EN ISO 9001* is the highly significant European Quality Norm fulfilled by scheppach's management system. Certification achieved through an independent quality and environmental expert's report and assessment.

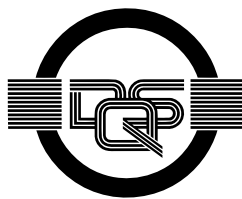

Without guaranteed service scheppach would be incomplete.

Everything offered by scheppach has a guaranteed seal of approval. We work to the strictest safety and environmental conditions stipulated by regulating authorities. Stricter safety controls simply do not exist. We are proud to display each seal of approval as illustrated on the left. In addition, the scheppach 2 year guarantee on all our machines demonstrates the confidence we have in the products we offer.

But the scheppach guarantee extends well beyond the point of sale.

Progress, innovation and service have always been standard at scheppach:



Our "**Delivery Guarantee**" means that you can expect to receive your machine with minimum delay. Our shortened delivery time is a result of our newly re-structured production lines.

Our "**Customer Support Guarantee**" is supported by a vast stock of spare parts for both current models and machines which were long since discontinued.

Our "**Express Guarantee**" means that even in export countries, if things go wrong and your local supplier does not have the part you require, we can supply parts by "Paketdienst" – an express postal delivery service that enables you to be up and running in the shortest possible time.

Our "**Good Spirit Guarantee**" includes choosing distributors that have scheppach customers at heart so that even export customers can enjoy the same support that is offered to German woodworkers.

"**Good Advice Is Inexpensive Guarantee**". Wherever you are located we support scheppach customers with the best expert advice. Our export distributors have access to our after sales service Hotline.



The scheppach offer for your workshop

Sawing	6-35	Planing	34-39	Sanding	48-55	Drilling	62-63
Sawbenches:	New!	Solo planing machines:		Belt/disc sanding machines:		Radial Drill Presses:	
ts 2010,		hms 2600 ci	New! 34	bsm 2010	New! 48	rab t16x, rab s16x	62
ts 2500 ci,		hms 3200 ci	35	bts 900x	49	Summary	63
ts 4010 ci	6-11	Combi planing machines:		Double end grinders:		Roller stands:	
Site and construction saws:		hmc 2600 ci	36	bg 150,	New!	rb, kb, asr	64
tku	New! 12-13	hmc 3200 ci	37	bg 200	New! 50	Extractors	65-69
ts 315 GT	14-15	Summary	38-39	Summary	51	Chip & Dust Extractors:	
bs 400,	New!	Combi system	40-41	Wet stone grinders:		ha 2000	65
bs 500	16-17	Mortising attachment:		TiGer 2000,		ha 2600	New! 66
Summary	18-19	lbe 16	40	TiGer 2500	52	ha 3210	67
Pullthrough Mitre Saws:		Moulding attachment:		Summary	53	Summary	New! 68
Capas 2	20	tfe 30	41	Accessories	54-55	Accessories	New! 69
Capas 3	21	Moulding	42-47	Glueing		Mortiser:	
Undercut mitre saws:		Vertical spindle moulder:		Adhesive presses:		hmc 25	70-71
tkg 260i	New! 22	hf 3000 ci	New! 42-43	Plano 1100, Plano 1250	56		
tkg 305i	23	Summary	44	Turning	57-61		
Summary	24-25	Profile knives	45	Woodturning lathes:			
Sawblades	26-27	Tools	46-47	dmt 450	57		
Bandsaws:				dms 900	58		
Basato 1	New! 28			dms 1100	59		
Basato 3 vario	29			Summary	60		
Basato 5-2	30			Accessories	61		
Summary	31						
Scroll saws:							
deco 401, deco 402,							
ds 403 vario,							
deco-tronic	32-33						



scheppach

saws

ts 2010

Modular Saw

Accurate – versatile – portable. Ideal for the small workshop or on site. The new scheppach ts 2010 circular sawbench.

With the new ts 2010 circular sawbench, scheppach offers all the versatility of a professional machine in a compact sawbench that is perfect for even the smallest workshop. Optional table extensions can be dismantled in seconds so the machine can be transported in the boot of a car. Even the cabinet base folds flat for transporting or storage. The table width and length extensions work on the “tongue and groove” principle and quickly slot together to form a large working surface if required.

scheppach innovation.

Included as part of the standard specification is scheppach's patented Duplex dual rise & fall/tilt mechanism offering both rapid and fine adjustment to the height and tilt settings from a single hand-wheel which is conveniently positioned at the front of the machine.

No other sawbench betters the accuracy of the scheppach “T-Square” saw fence system giving accuracy of 1/10 of a millimetre to the rip fence setting which is



New!

The ts 2010 with optional table width and length extensions, sliding table carriage and cabinet base.

enhanced by the magnifying glass. Precise stops are provided for 0 and 45 degree tilt settings and both TCT sawblade and mitre gauge come as standard. Efficient sawdust extraction from the overhead crown guard and main sawdust chute is also included.

Start with the basic machine for bench mounting or add scheppach's precise sliding table carriage and table width and length extensions. And from the

moment your wood comes into contact with that constant 52 m/second cutting speed powered by the 1.8 HP single phase motor, you will experience that feeling of sawing satisfaction that is rarely found in a machine of this size.

scheppach quality has never been this affordable.



The folding stop on the fence rail incorporates micro adjustment to 1/10th mm.



Fine adjustment for the ripping fence comes as standard.



- Special features**
- ✓ powered by an induction motor
 - ✓ 60 mm depth of cut
 - ✓ Clean tear-free cuts with 52 m/sec speed
 - ✓ 1/10th mm accuracy on rip and crosscut settings
 - ✓ Total versatility through modular table extensions
 - ✓ Mobility if required
 - ✓ Duplex System. Patented height and angle settings for rapid and fine positioning

The ts 2010 in standard version.



Accessories

Base unit
Foldable
Order No. 5322 0704



Sliding table carriage
With precision angle fence, adjustable to 60° left and right, guide rail 950 mm long.
Order No. 5322 0701



Table width extension
Foldable, 610 x 250 mm
Order No. 5322 0703

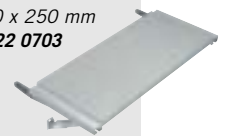
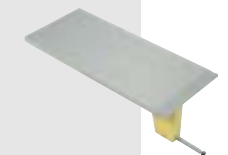

Table length extension
575 x 250 mm
Order No. 5322 0702



For for sawblades see pages 26 and 27

scheppach

saws

ts 2500 ci

Superior Saw

Economic sawing excellence – the new scheppach ts 2500 ci circular sawbench with cast iron table.

Sawing efficiency demands accuracy and stability. Both are incorporated into the new scheppach ts 2500 ci circular sawbench which now comes with cast iron saw table as standard.

With an impressive 87 mm depth of cut – backed up with a 5.2 HP motor (3.5 HP single phase) and a constant cutting speed of 54 m/second for splinter free cutting, sawing performance doesn't come any better than this from an economy range sawbench.

If you decide to increase the cutting capacity of your sawbench you can choose the same high quality optional table width & length extensions and sliding table carriage that are available for the precision ts4010ci professional circular sawbench. Therefore whether you need only the basic machine or you choose to enhance its performance with "add-ons" you know that with the scheppach ts2500ci, you are getting the very best that money can buy.

Table slots to both left and right of the sawblade accept



The ts 2500 ci with optional sliding tablecarriage, folding table with extension and table length extension.

the mitre gauge which gives 0–60 degree settings. Dust extraction from the crown guard as well as the main sawdust chute is included as part of the standard equipment, thus meeting all the demands of those who are as concerned with health issues as they are about cutting performance.

Table width and length extensions plus a choice

of two sliding carriages are available as optional attachments allowing a cutting capacity of up to 800 mm or 1,400 mm in front of the sawblade. When fitted with the folding table width extension, an 1,100 mm cutting capacity to the right of the sawblade can be achieved.

To complete the versatility of this popular machine

ci Series

- Heavy duty cast iron saw table

scheppach now offer an expanding grooving cutter for trenching, grooving and rebating etc as part of the accessory range. A special SUVA guard is required for all hidden cuts.

If workshop space is a problem then the option of a wheel base will allow you to move the machine single handed.

Exact straight cuts are the result of smooth running, stability and power.



The ts 2500 ci with the unique adjustable groove cutter (optional). (SUVA guard is recommended for all hidden cuts)



The ts 2500 ci – operating with the adjustable groove cutter. (SUVA guard is recommended for all hidden cuts)

Accessories

Sliding carriage table
with precision angle fence,
adjustable by 45°, guide rail
1,400 mm long.
Order No. **7981 0100**

With guide rail
2,000 mm long
Order No. **7979 0100**



Fence rail
1,350 mm for extension
of fence length to
2,500 mm
Order No. **5320 8180**

Ruled fence rail
1,500 mm
Order No. **5410 7003**

Wheel base
Order No. **5300 0705**

Table width extension
folding, 800 x 640 mm
Order No. **7980 0100**



Table length extension
800 x 480 mm
Order No. **7324 0170**



Suva suction attachment
Complete with 2 extraction
hoods for crosscuts and
straight cuts.
Order No. **5460 1100**



Fine adjustment
with adjustment
to millimetre
Order No. **5410 7800**



Adjustable grooving cutter
with TC reversible knives,
tool body in steel, ø
200 x 8 mm –
15 x ø 30 mm,
T max 75 mm
Order No. **7231 0709**



Adjustable grooving cutter
with spacing circle, tool
body in steel, 3
pieces, ø 150 x 4
mm – 15 x ø 30
mm, T max. 45 mm,
Z 4, 5.000 – 8.000 rpm
Order No. **7231 0710**



Table insert and collar nut
Order No. **5300 0710**

for sawblades
see pages 26 and 27

schepach

saws

ts 4010 ci

Ultimate Saw

The ultimate circular saw-bench for precision and versatility. More than 70 years of German technical "know-how" packed into this high performance cutting machine.

The new ts 4010 ci circular sawbench is the flagship of the schepach "ts" series of circular sawbenches. It combines the excellence of German engineering technology with the results of a listening ear and paying attention to the demands of our world-wide customer base. No clearer example of this is found than with the introduction of the new ts 4010 ci model which includes all the benefits of a heavy duty cast iron saw table.

Offering an impressive maximum depth of cut, this machine is ideal for the professional workshop but its competitive price still enables it to be within the budget range for the home user where nothing but the very best will do.

The ts 4010 ci sawbench includes the patented schepach Duplex dual rise & fall and tilt mechanism which gives rapid and fine height adjustment to the height and tilt settings from a single handwheel. A constant cutting speed from the massive electric motor provides splinter free cut-

ing from the standard TCT sawblade. But for the "unbelievers" there is always the option of a traditional scoring unit. Adjustable grooving saw accessories offer the possibility for trenching, grooving and rebates etc. A special SUVA crown guard system is required for all hidden cuts.

When equipped with the optional folding table width extension, up to 1100 mm

New!

ci Series

• Heavy duty cast iron saw table



The ts 4010 ci with optional table length and width extensions, sliding table carriage

width of cut is possible. A choice of two sliding table carriage units allow up to 1400 mm cutting capacity in front of the sawblade. An optional wheel kit allows the machine to be moved to the desired working position by one person.

Traditional values with the latest innovations. You will find them only in the schepach ts 4010 ci.

Special features

- ✓ 107 mm depth of cut
- ✓ Heavy duty cast iron table
- ✓ 1/10th mm accuracy on rip and crosscut settings
- ✓ Duplex System. Patented height and angle settings for rapid and fine positioning
- ✓ Clean tear-free cuts with 66 m/sec speed



Biggest cutting depth in its class: 107 mm

With the ts 4010 ci you can saw wood up to 107 mm thick with a finish as though it is planed.



ts 4010 ci

Ultimate Saw



Scoring attachment (optional) for splinter free cutting of laminated and surface coated boards, MDF.



ts 4010 ci – operating with the adjustable groove cutter (SUVA guard is recommended for all hidden cuts)

Accessories

Sliding carriage table
with precision angle fence, adjustable by 45°, guide rail 1,400 mm long.
Order No. **7981 0100**

With guide rail
2,000 mm long
Order No. **7979 0100**



Fence rail
1,350 mm for extension of fence length to 2,500 mm
Order No. **5320 8180**

Ruled fence rail
1,500 mm
Order No. **5410 7003**

Wheel base
Order No. **5300 0705**

Table width extension
folding, 800 x 640 mm
Order No. **7980 0100**



Table length extension
800 x 480 mm
Order No. **7324 0170**



Suva suction attachment
Complete with 2 extraction hoods for crosscuts and straight cuts.
Order No. **5460 1100**



Fine adjustment
with adjustment to millimetre
Order No. **5410 7800**



Adjustable grooving cutter
with TC reversible knives, tool body in steel, ø 200 x 8 mm – 15 x ø 30 mm, T max 75 mm
Order No. **7231 0709**



Adjustable grooving cutter
with spacing circle, tool body in steel, 3 pieces, ø 150 x 4 mm – 15 x ø 30 mm, T max. 45 mm, Z 4, 5.000 – 8.000 rpm
Order No. **7231 0710**



Table insert and collar nut
Order No. **5300 0710**

Scoring attachment
complete with scoring sawblade, non-slewing, driving speed 7,100 rpm cutting speed of scoring saw blade 30 m/sec, only for use with special saw blade ø 250 mm
Order No. **5470 7004**

Scoring sawblade
for scoring attachment
80 mm ø
Order No. **5460 1220**

Special sawblade
250 mm ø for scoring attachment (see sawblades)

for sawblades
see pages 26 and 27

schepach

saws

tku

**Economical versatility –
tku circular sawbench**

Portable, versatile, outstanding performance, rigid and accurate. These sawbenches represent amazing value for money. Their generous specification fulfills the need for ripping, crosscutting, angle and compound angle cuts.

**Getting the most of
your tku.**

A host of useful optional attachments can be added if required. The most popular is the sliding table carriage. Perfect for accurate crosscuts and mitres. Fixed left and right angle settings are provided and the fence is equipped with an adjustable turnover stop for repeat cuts. This attachment is now available in two sizes. There is also a folding side extension for cutting panels. And if your machine is regularly on the move, the wheel kit makes light work of transporting this machine. Of particular importance to the discerning buyer is the rip fence which can be instantly locked and released for appropriate positioning. When locked it is totally rigid. No flexing or wavering under side

New!



The tku with sliding table carriage, panel-cutting attachment, support leg and wheel base.

pressure. The sawbench comes with the saw/motor unit, pre-factory assembled, leaving minimal assembly to the final user.

Safety – an integral part of the tku.

Equipped with an electronic motor brake, the sawblade

comes to a standstill within seconds. Safety is enhanced by the table length extension coming as standard.

Safety

✓meets the latest safety regulations and standards (EN 1870-1)

Special feature

Column-guided rise & fall assembly

Only schepach sawbenches offer this degree of accuracy



The original
and still the best
site sawbench!
New improved
model

Special features

- ✓ column guided rise & fall system converts this economical machine into an accurate cutting sawbench for ripping, crosscutting, angles, panel sizing
- ✓ unique schepach cam-lock "T-fence" system for total accuracy of saw fence setting
- ✓ optional attachments allow extreme versatility for both workshop or site use
- ✓ simple but accurate height and tilt settings
- ✓ table length extension comes as a standard
- ✓ crown guard/main chute extraction facility & TCT sawblade included

Accessories

Sliding table carriage

runs on ball bearings, fence rail adjustable from -45° to $+45^\circ$, guide rail 1,200 mm long, cutting width 580 mm, cutting depth 40 mm.
Order No. **7951 0000**

Sliding table carriage

Sliding table carriage; travels on triple rollers, adjustable from -45 to $+45$, 1500mm long guide rail.
Order No. **7951 0901**

Fence rail

850 mm – 1,500 mm
Order No. **5320 8183**

Fence rail

1,350 mm – 2,500 mm
Order No. **5320 8180**

Ruled fence rail

1,500 mm
Order No. **5410 7003**

Folding stop

with fine adjustment
Order No. **7939 0301**

Longer guide rail

1,500 mm, galvanised
Order No. **7951 4100**

Wheel base

Order No. **7962 0000**

Panel cutting attachment

folding, with parallel fence, adjustable up to 950 mm.
Order No. **7961 0901**

Riving knife

For use with TCT sawblades with cutting width of 3.0/3.2 mm
Order No. **5280 0016**

Set of push handles

(2 pieces)
Order No. **7963 1000**

for sawblades
see pages 26 and 27

scheppach

saws

ts 315 GT

**ts 315 GT circular sawbench
– designed and built
for stability and accuracy.**

No matter whether you depend on accuracy for interior woodwork, regular joinery, or even constructing your new home – the ts 315 GT is ready for universal use, meeting professional demands in every field. The reason for this precision (that no competitor's allround circular sawbench can equal) is the unique column guided rise & fall assembly. For professional tasks, the ts 315 GT also offers the corresponding possibilities: The galvanized table top is largely dimensioned, a table length extension is part of the standard equipment. The optional panel cutting attachment offers a solid working base.

While demanding minimum workshop space, the machine offers a large working surface. The optional patented panel cutting attachment (also retro-fittable) only occupies space when it is used. When not needed, it conveniently folds away. Thanks to the standard wheel base, the ts 315 GT is fast and easily moved to the following place of work.

Safety

✓meets the latest safety regulations and standards (EN 1870-1)



The ts 315 GT with optional sliding table carriage and panel cutting attachment.

Special feature

Column-guided rise & fall assembly

Only scheppach sawbenches offer this degree of accuracy



Special features

- ✓ column guided rise & fall system converts this economical machine into an accurate cutting sawbench for ripping, crosscutting, angles, panel sizing
- ✓ unique scheppach cam-lock "T-fence" system for total accuracy of saw fence setting
- ✓ optional attachments allow extreme versatility for both workshop or site use
- ✓ simple but accurate height and tilt settings
- ✓ table length extension comes as a standard
- ✓ crown guard/main chute extraction facility & TCT sawblade included



Optional patented "foldaway" panel cutting extension and removable sliding table carriage minimise workshop space. Ideal for transporting.

Accessories

Sliding table carriage
running on ball bearings,
fence rail adjustable
2 x 45°, 1200 mm
long guide rail
Order No. **7951 0000**

Sliding table carriage
running on ball bearings,
fence rail adjustable
2 x 45°, 1500 mm
long guide rail
Order No. **7951 0901**

Fence rail
extensible from 850 to
1500 mm
Order No. **5320 8183**

Fence rail
extensible from 1350 to
2500 mm
Order No. **5320 8180**

Ruled fence rail
1500 mm
Order No. **5410 7003**

Folding stop
with fine-adjustment
Order No. **7939 0301**

Aluminium fence rail
2000 mm
Order No. **7951 4002**

**Panel cutting attachment
with support**
folding down, with
parallel fence,
adjustable up to 950 mm
Order No. **7961 0901**

for sawblades
see pages 26 and 27

schepach

saws

bs 400

bs 500

For the tough requirements on the building site – the construction saws bs 400 and bs 500.

The solid, galvanized table, together with the torsion-resistant base, is the prerequisite to cope with the daily work on construction sites.

The results are permanently precise cuts of utmost quality which, thanks to the powerful motors, are easily obtained even at maximum cutting performance.

schepach innovation.

The newly developed swing-guard with the wide and solid riving knife meets the strictest demands of the professional associations for accident prevention by offering optimum safety for the operator. Further plus points of this protective hood are: simple cutting of wide boards, or the transport through doors without having to remove a fixing arm of the guard (often required with competitors' machines).

Another advantage – the folding table length extension allowing the safe and easy separation of long work pieces like boards and planks. The precision mitre gauge (standard equipment) permits smooth angle cuts.

New!



The bsh 500 shown with sliding table carriage guarantees maximum precision even under extreme conditions.



schepach
saws

bs 400

bs 500

Safety
✓ meets the latest safety regulations and standards (EN 1870-1)



The standard crosscut/mitre gauge glides over the table length on a guide rail.

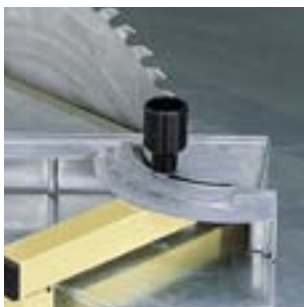

Accessories

Wheel base
Order No. 5600 7000

ruled fence rail
1,500 mm
Order No. 5410 7003

sliding table carriage
Order No. 5645 0701

for sawblades
see pages 26 and 27

- ts 2010
- ts 2500ci
- ts 4010ci
- tku
- ts 315 GT
- bs 400
- bs 500



Sawing

Standard equipment	<i>Big table plate, anodized aluminium profiles, sawblade guard, suction hose for top sawblade guard, suction connector for dust free working, precision ripping fence with magnifying glass and angle fence rail, height and angle adjustment with handwheel (patent), Poly-v belt drive, TCT sawblade, induction motor, push stick, push grip, tool for changing the sawblade</i>		<i>Cast iron table plate, precision ripping fence with turning fence rail, crosscut/mitre gauge, sawblade guard, suction hose for top sawblade guard, suction connector for dust free working, TCT sawblade, push stick, push grip, tool for changing the sawblade, rear take-off table</i>		<i>Cast iron table plate, precision ripping fence with fine adjustment, magnifying glass and turning fence rail, crosscut/mitre gauge, sawblade guard, suction hose for top sawblade guard, suction connector for dust free working, TCT sawblade, push stick, push grip, tool for changing the sawblade, rear take-off table</i>		<i>Galvanized solid table, powder coated base, folding table length extension, fence with eccentric clamping system and reversible stop rail, mitre gauge with integrated wedge cutting gauge, CV sawblade, swinging protective hood, crane eyes, push stick and handle, assembly tools</i>
Test certificates	CE, GS, sawdust tested		CE, GS, sawdust tested		CE, GS, sawdust tested		CE, GS
Technical data							
<i>l/b/h mm</i>	720/450/300		1,100/680/1,110		1,100/680/1,130		1,075/790/1,035
<i>Table size mm</i>	480 x 600		800 x 680		800 x 680		1,000 x 675
<i>Table height mm</i>	305/865 with base unit		850		850		800
<i>Sliding carriage mm</i>			420 x 670		420 x 670		715 x 405
<i>– Sawblade ø mm/teeth</i>	200/24		270/24		315/48		400/56
<i>Height adjustment mm</i>	0 – 62		0 – 87		12 – 107		
<i>– Sawblade ø mm</i>					250 (Accessory)		
<i>Height adjustment mm</i>					0 – 74		
<i>Tilting range °</i>	45		45		45		
<i>Speed rpm</i>	5000		3,800		4,000		2,760
<i>Cutting speed m/sec</i>	52		50		66		58
<i>Ripping fence length mm</i>	453		800		800		580
<i>Angle fence °</i>	2 x 60		2 x 60		2 x 60		90
<i>Suction connector ø mm</i>	50 and 100		100		100		
<i>Weight approx. kg</i>	36		120		155		86
Cutting data							
<i>Cutting width or depth</i>							
<i>– with ripping fence</i>	230		405		390		370
<i>– with table width extn.</i>	480		1100		1100		
<i>– with angle fence mm</i>	250		260		260		300
<i>– with sliding carriage</i>	600		800/1,400		800/1,400		
<i>Cutting depth at 90° mm</i>	60		87		107		105
<i>Cutting depth at 45° mm</i>	48		64		75		
Motor	220–240 V/50 Hz		230 V/50 Hz	400 V/50 Hz	220–240-V/50 Hz	380–420-V/50 Hz	230 V/50 Hz
<i>Input kW (HP)</i>	1.8 (2.5)		2.6 (3.5)	3.8 (5.2)	3.0 (4.1)	4.0 (5.4)	3.5 (4.8)
<i>Output kW (HP)</i>	1.2 (1.6)		2.0 (2.7)	2.9 (4.0)	2.2 (3.0)	3.0 (4.1)	2.6 (3.5)
<i>Speed rpm</i>	2,800		2,740	2,690	2,800	2,840	2,760
<i>Brake</i>	no		yes	yes	yes	yes	yes
<i>Motor protection</i>	yes		yes	yes	yes	yes	yes
<i>Switch/plug unit with no-volt release</i>	yes		yes	yes	yes	yes	yes
Order No.	5322 0901		5301 0909	5301 0910	5460 0909	5460 0910	5645 0901

- ts 2010
- ts 2500ci
- ts 4010ci
- tku
- ts 315 GT
- bs 400
- bs 500



bs 500



ts 315 GT



tku

Galvanized solid table, powder-coated base, folding table length extension, fence with eccentric clamping system and reversible stop rail, mitre gauge with integrated wedge cutting gauge, CV sawblade, swinging protective hood, crane eyes, push stick and handle, assembly tools

Large, galvanized sawtable, table length extension with supporting leg, ripping fence with fence rail, suction connector for dust-free working, sawblade guard with suction hose, solid, non-skid rubber feet, wheel base, push stick, push handle, tool for changing the sawblade, TCT sawblade

Ripping fence with fence rail, aluminium table insert, table extension with support leg, extraction hood, suction connector, push stick, assembly tool, TCT sawblade, handwheel R & F

CE, GS

CE, GS, sawdust tested

CE

1,075/790/1,035
1,000 x 675
800
715 x 405
500/56

1,280/700/1,100
790 x 590
850
410 x 400
315/20
0 - 82

1,270/680/1,150
750 x 570
850
450 x 540
315/20
0 - 80

2,770
73
580
90
86

45
2,800
46
580
90
100
53

45
2,800
46
580
90 (Accessory)
100
55

370
250
155

345
1,050
220
500
82
60

290
1,000
240
520
85
65

400 V/50 Hz
5.0 (6.8)
4.0 (5.4)
2,770
yes
yes
yes

220-240 V/
50 Hz
2.2 (3.0)
1.5 (2.1)
2,800
yes
yes
yes

400 V/50 Hz
3.0 (4.0)
2.2 (3.0)
2,800
yes
yes
yes

400 V/50 Hz
4.2 (5.7)
3.0 (4.1)
2,800
yes
yes
yes

230 V/50 Hz
2.2 (3.0)
1.6 (2.2)
2,800
yes
yes
yes

400 V/50 Hz
3.0 (4.0)
2.2 (3.0)
2,800
yes
yes
yes

400 V/50 Hz
4.2 (5.7)
3.0 (4.1)
2,800
yes
yes
yes

5645 0902

5277 0901

5277 0902

5277 0903

5267 0906

5267 0907

5267 0908

scheppach

saws

Capas 2

**Faster, higher, further –
the master of its class
is always ahead.**

The Capas 2 crosscuts, angles and compound angles, all in one easy stroke of the saw. It gives precise cuts through timber or boards up to a width of 320 mm. It gives a 65 mm depth of cut and cuts angles – left and right – up to 45°. A sliding compound mitre saw to your advantage.

This portable machine opens up new dimensions in the woodworking projects. It is easy to transport, allows efficient and convenient working, and ensures first-class working results due to high precision. And not to forget: cutting from above and sawing in one operation saves your handling and facilitates your work.

**Mobile working.
Thanks to scheppach.**

Special features

✓Cutting width 320 mm

✓Cutting height 65 mm

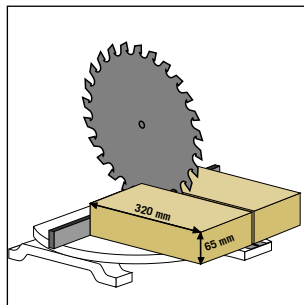

The Capas 2 offers a cutting width of 320 mm at a cutting height of 65 mm.

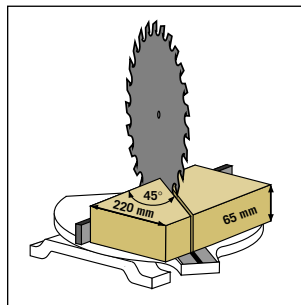

Even at an angle of 45° it cuts wood, plastic and aluminium up to 220 mm width.

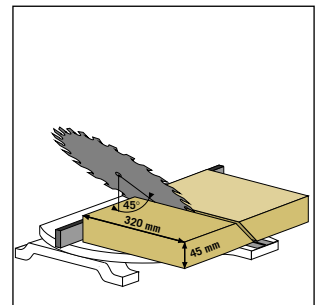

Tilted cutting angles of 45° and horizontal cutting angles from -48° to +48° can be precisely calibrated.

Special features
 ✓ Cutting width 320 mm
 ✓ Cutting height 102 mm



Cutting from above and sawing in one operation.

The Capas 3 pull through mitre saw: with sensational cutting widths of up to 320 mm and a cutting height of up to 102 mm this classic tool becomes even more effective, cutting from above and sawing in one operation.

Precision at hand: with the torsion free guide, not only can you cut strips and profiles exactly and continuously to 48°, but also cut panels and boards precisely to length. The turntable with grid makes possible the most complicated angle cuts round a corner quickly and comfortably.

Two operations in one thanks to schepach.

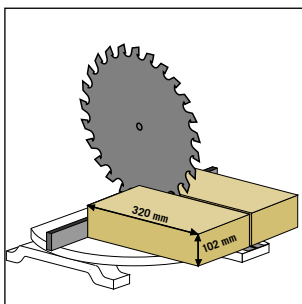

320 mm width with a height of up to 102 mm – the Capas 3 offers the best capacity in its class.

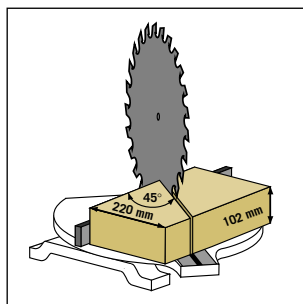

Even at an angle of 45° it cuts wood, plastic and aluminium up to 220 mm width.

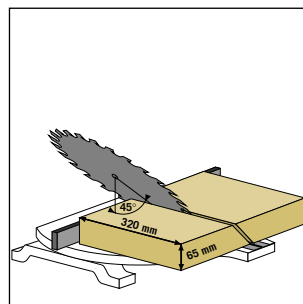

Tilted cutting angles of 45° and horizontal cutting angles from -48° to +48° can be precisely calibrated.

scheppach

saws

tkg 260i



aluminium

non ferrous metals



**scheppach mitre saw tkg 260i
– the mobile workshop for
both right and left hand users.**

When it comes to cutting wall and floor trim panels – moulding strips – door and window frames: a scheppach mitre saw takes them all in its stride and will produce a clean and precise cut every time. They are easy to transport so are equally at home on site or in the workshop.

A major consideration when choosing the right mitre saw is the motor unit. Both scheppach tkg 260i and tkg 305i mitre saws are powered with induction motors which are quiet and suitable for operating in noise sensitive areas, compared to many others which have noisy universal brush motors and require much more maintenance.

Combination mitre saws which include a sawbench facility are perfect for precise crosscuts, angle and compound angle cuts, but can also be used for ripping. The scheppach tkg 260i gives an impressive 150 mm width of cut and a 40 mm depth of cut when ripping. In angled mode the head tilts through 45 degrees and the base rotates through 45 degrees to allow for

sawing bevels, mitres and compound mitres. The saw table measures 410 x 280 mm and is made from a die casting for utmost accuracy. The rip fence is held rigidly in position and will not wander under pressure. To adjust the depth of cut you simply raise or lower the saw table.

The powerful 1.6HP induc-

tion motor incorporates a soft start which eliminates any initial jolt start and safety is enhanced by the motor brake which brings the sawblade to a standstill within seconds of releasing the trigger switch. You may feel spoilt for choice when it comes to choosing the right mitre saw: that is until you look the scheppach tkg 260i.



The tkg 260i set for cutting compound mitres, with optional base.





plastics

laminated woods

solid woods



tkg 305i



The tkg 305i set for ripping cuts with optional base.

Special feature

Ripping cuts up to 50 mm cutting height above table

A major consideration when choosing the right mitre saw is the motor unit.

Both scheppach tkg 260i and tkg 305i mitre saws are powered with induction motors which are quiet and suitable for operating in noise sensitive areas, compared to many others which have noisy universal brush motors and require much more maintenance.



scheppach tkg 305i mitre saw. Big precise cutting capacity on site – suitable for right and left hand users.

Whether you are cutting tubes to length, cutting profiles, mitre cuts, cutting panels, flooring, or ripping, the scheppach tkg 305i combined mitre saw will do them all and is also suitable for ripping.

The powerful dust protected 1.9 HP induction motor will provide years of maintenance free service and is equipped with a brake which will bring the sawblade to a standstill in under ten seconds. The precision cast aluminium machined base and saw table guarantees the highest quality precision cuts in both mitre and ripping cutting modes. The tkg 305i offers a cutting capacity of 160 mm wide and ripping to a depth of 50 mm. In angled mode the head tilts through 45 degrees and the base rotates through 45 degrees to allow for sawing bevels, mitres and compound mitres.

It is not difficult to understand why the scheppach tkg 305i is the choice of the professional.

scheppach mitre saws: worth more than a second look.

Capas 2

Capas 3

tkg 260i

tkg 305i



Capas 2



Capas 3



tkg 260i



tkg 305i

Standard equipment	Diecast aluminium base and rotary plate, locking positions, workpiece stop, suction connection, TCT sawblade, chip collection bag L/R table extension with folding stop, additional stop, chip bag, screw clamp, 40-tooth TCT sawblade of TF shape	Diecast aluminium base and rotary plate, locking positions, workpiece stop, TCT sawblade, "Soft start" to electric motor, additional stop, chip collection bag, extraction connector, connector hose Y piece, extension hose for industrial extraction unit, L/R table extension with folding stop, screw clamp for securing the workpiece.	Diecast aluminium rotary plate and table top, aluminium frame, powder coated, aluminium table plate for ripping cuts, with scale for ripping fence, smooth running induction motor, locking pin for grid positions with additional clamp, workpiece stop for mitre cuts left and right usable, TCT sawblade, tool for changing the sawblade	Diecast aluminium rotary plate and table top, aluminium frame, powder coated, aluminium table plate for ripping cuts, with scale for ripping fence, smooth running induction motor, locking pin for grid positions with additional clamp, workpiece stop for mitre cuts left and right usable, TCT sawblade, tool for changing the sawblade
Test certificates	CE	CE, GS	CE	CE
Technical details l/b/h mm Work surface mm Table size mm Sawblade ø mm/teeth Tilt arca – Mitre angle ° – Slope angle ° rpm Grid position by ° Extraction connector ø mm Weight approx kg	590/980/500 525 x 335 216/40 –48 to +48 45 5,000 0/15/22.5/31.6/45 40 23	590/1,080/700 525 x 350 305/60 –48 to +48 45 4,000 0/15/22.5/31.6/45 40 26	470/460/580 410 x 280 250/24 2 x 45 1 x 45 2,850 0/15/22.5/30/45 28/40 17	470/460/660 410 x 280 300/40 2 x 45 1 x 45 2,850 0/15/22.5/30/45 28/40 20
Cutting details Cutting height max at 90/45° Cutting width max at 90/45° Cutting height over table mm	65/45 320/220	102/65 320/220	40 150 x 50 95 x 50	50 160 x 70 100 x 70
Motor Input kW (HP) Output kW (HP)	230 V/50 Hz 1.12 (1.52) 0.65 (0.9)	230 V/50 Hz 1.8 (2.5) 1.0 (1.36)	230 V/50 Hz 1.2 (1.6)	230 V/50 Hz 1.4 (1.9)
Order No.	8800 1916	8800 1901	8932 0903	8932 0904



- Capas 2 _____
- Capas 3 _____
- tkg 260i _____
- tkg 305i _____

Accessories

For tkg 260i

Screw clamp
Order No. **8932 0706**

Crosscut/mitre gauge
Order No. **8932 0705**

Dust bags
*For all scheppach undercut/
mitre saws*
Order No. **8932 0707**

Base Unit ust 2080 (see large picture)
*for all scheppach undercut/
mitre saws, folding, adjust-
able to 4 heights, table
height 780 mm*
Order No. **8932 0703**

Base Unit ust 600
*For all scheppach
undercut/mitre saws.
table size
600 x 560 mm*
Order No. **8932 0704**



*for sawblades
see pages 26 and 27*

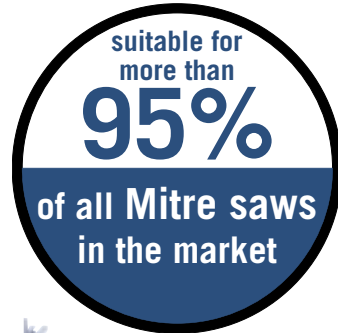

*A universal mitre saw stand
that can be adjusted to accept
nearly all makes of mitre saw.*



Suitable for any special task – scheppach sawblades

scheppach precision circular saw blades. scheppach saw blades are manufactured in the most modern, laser and CNC controlled plants. For this reason, they ensure highest precision meeting the expectations of the most demanding tradesmen. Due to the universal carrier hole of 30 mm, scheppach precision saw blades can be used on almost all circular saw benches.

For all types of application, from solid wood to laminated particle boards, from non-ferrous metals to plastics – scheppach offers you the perfect saw blade.

TCT saw blades

alternating teeth, 30 mm bore for ripping in soft or hard wood and cross cuts in solid wood, boards laminated on one side and plastics

ø mm	tooth width	No. of teeth	Order No.	suitable for
200	2,8	24	5320 6508	ts 2000/ts 2010*
200	2,8	48	5320 6509	ts 2000/ts 2010
216	2,8	48 neg.	8800 1841	Capas 1/Capas 2
250	2,4	24	8932 0708	tkg 260e/tkg 260i*
250	3,2	42	5300 8001	ts 2500/kse 250
250	2,4	48	8932 0709	tkg 260e/tkg 260i
250	2,4	60	8932 0710	tkg 260e/tkg 260i
270	3,2	36	5300 0707	ts 2500ci
270	3,2	80	5300 0708	ts 2500ci
300	2,4	24	8932 0713	tkg 305e/tkg 305i
300	2,4	48	8932 0712	tkg 305e/tkg 305i
300	3,2	60	5460 0701	tku/ts 315GT/ts 4010/ts 4010ci
300	2,4	80	8932 0714	tkg 305e/tkg 305i
305	3,2	48 neg.	8800 1843	Capas 3
305	3,2	48	8800 1844	Capas 3
315	3,2	48	5100 5506	tku/ts 315GT/ts 4010/ts 4010ci*

* Standard accessory

TCT saw blades

alternating or flat teeth, version for limited cutting depth, 30 mm bore, for ripping in soft and hard wood

ø mm	tooth width	No. of teeth	Shape of teeth	Order No.	suitable for
250	3,2	24	WZ	5300 0702	ts 2500/kse 250
270	3,2	24	WZ	5300 0706	ts 2500ci*
300	3,2	28	WZ	5100 5501	tku/ts 315GT/ts 4010/ts 4010ci
315	2,8	20	FL	5100 5102	tku*/ts 315GT*
315	3,2	28	WZ	5100 5510	tku/ts 315GT/ts 4010/ts 4010ci
400	3,5	36	WZ	5600 9101	bsh 400/bs 400
500	4,0	44	WZ	1527 0704	bsh 500/bs 500/wox 500

* Standard accessory

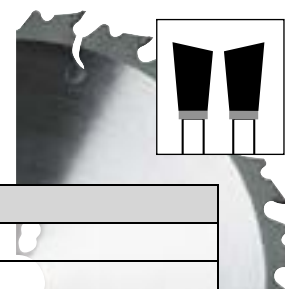
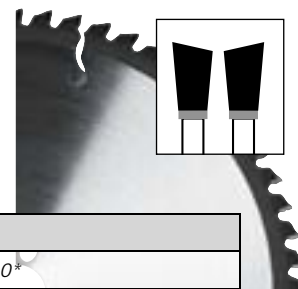

Special TCT saw blades

extreme alternating teeth, 30 mm bore,
for boards laminated or coated on both sides, MDF

ø mm	tooth width	No. of teeth	Order No.	suitable for
250	3,2	80	5300 0703	ts 2500/ts 2500ci/kse 250
300	3,2	96	5460 0702	tku/ts 315GT/ts 4010/ts 4010ci

* Standard accessory

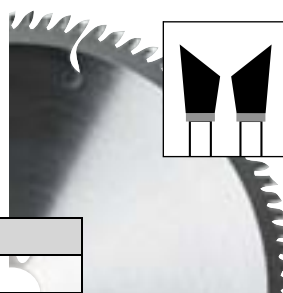

Universal TCT saw blades

alternating teeth, 30 mm bore, for mixed applications:
wood, panels not laminated, non-ferrous metals, plastics

ø mm	tooth width	No. of teeth	Order No.	suitable for
200	2,8	30	5320 0702	ts 2000/ts 2010
216	2,8	34	8800 1842	Capas 1/Capas 2
250	3,2	42	5300 0704	ts 2500/kse 250
300	3,2	48	5100 5504	tku/ts 315GT/ts 4010/ts 4010ci

* Standard accessory

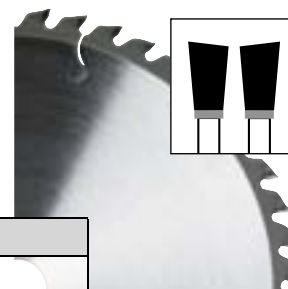

TCT saw blades

flat/alternating taper teeth, 30 mm bore,
for construction materials, rip and cross cuts

ø mm	tooth width	No. of teeth	Order No.	suitable for
400	4,0	28	5600 0701	bsh 400/bs 400
500	4,0	36	5600 0702	bsh 500/ bs 500

* Standard accessory

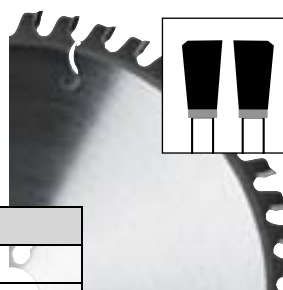

TCT saw blades

flat trapeze teeth, 30 mm bore, for non-ferrous metals, PVC

ø mm	tooth width	No. of teeth	Order No.	suitable for
250	2,4	80	8932 0711	tkg 260e/tkg 260i
300	2,4	80	8932 0715	tkg 305e/tkg 305i

* Standard accessory

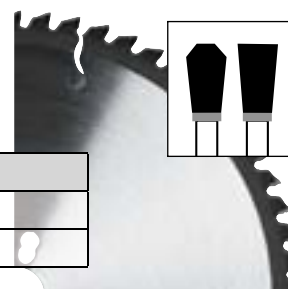

scheppach

saws

Basato 1

Junior Bandsaw

Realise your imaginative ideas with a scheppach Basato 1 bandsaw.

During late 1998 (following its introduction some twelve months earlier) the scheppach Basato 5-2 professional bandsawing machine achieved first prize for reader's choice of best new product in the prestigious PROFITIPS Building & Renovation magazine.

Next came the Basato 3 offering cutting capacity of 306 mm x 160 mm and bringing all scheppach Basato bandsaw features within the reach of most woodworkers. Only hobby woodworkers were possibly excluded from enjoying the quality and benefits of "Basato bandsawing". But it was only a matter of time before scheppach introduced a Basato bandsaw for even the smallest workshop.

scheppach now introduce the new Basato 1 hobby bandsaw. Other than variable speed control, this machine offers all the design features of larger Basato models. Like other Basato "family members" the Basato 1 boasts a solid cast iron table which is tiltable to 45° and has precise one

hand setting control. Unusual for this size of machine are the top and bottom triple roller precision guides included as standard equipment. A rigid fence system with magnifying glass for precise setting; a cutting capacity of 190 mm x 100 mm; balanced polished wheels with rubber

facing; all this and more finally enables everyone to have the joy of working with a Basato bandsaw.

Whatever the size of your workshop, your project or your budget, there is now a Basato bandsaw to suit you.

Convert your wood into the most imaginative shapes with a Basato bandsaws.



Evaluation of the professional press:

"... an excellent saw, working very well within its limits. It is ideal for simpler jobs like the production of toys or models ..."

From "woodworking magazine", England 2/2005

Performance



Ratio price/performance



schepach

saws

Basato 3 vario

**Bestseller
Bandsaw**

**Continuous speed control –
the Basato 3 vario.**

For perfect adaptation to individual types of material, the Basato 3 offers you as special feature continuous speed control within a range from 370 to 750 m/min ensuring, at the same time, utmost accuracy by means of top and bottom 3-roller precision guides. For smooth running, the balanced and polished band wheels are fitted with a rubber facing.

The tilting table copes with every task. The large cast iron table offers a safe work-piece support. The tilting table has a precise one hand setting control ranging from -17° to $+45^{\circ}$, while the throat width is 305 mm. The precision fence system is equipped with a magnifying glass. For your safety, the casing is protected by a door with a cut off switch.

**Special
feature**

Unique variable
speed drive system:
370 to 750 m/min



Basato 3 Vario
with optional leg stand.

The Basato 3 vario with the optional
sanding attachment (professional
accessory pack).

The new base unit with standard
wheel base.

**Statements in technical
magazines**

"...Clever features make it stand out from its competitors, and it would be ideal in any small workshop. If you're after a new bandsaw with decent capacities and fine adjusters I can strongly recommend this one. It's a beauty..."

(Excerpt from "Good Woodworking" Nr. 131, February 2003)

GW verdict

Value for money ●●●●○
Performance ●●●●○

**selbst
ausprobiert**

TTTT

TTTT = very good TTT = good
TT = useful T = not functional

(Excerpt from "Selbst ist der Mann", 4/03)

Precision rip fence with magnifier.
Conveniently inserted from above
for right and left hand use.
Twin-3-roller-precision blade guides
ensure precise cuts.



Variable speed control by conveniently placed hand wheel.
Large cast iron table with swivel capacity of -17° to $+45^{\circ}$ enhances versatility.



scheppach

saws

Basato 5-2

Ultimate Bandsaw

Professional specification: professional results with the scheppach Basato 5-2 bandsaw.

With a scheppach Basato bandsaw you can realize all your imaginative expectations. Awarded first prize in a European Machine of the Year competition. An independent test report concluded, "so is the scheppach Basato the ultimate bandsaw? It's not far off".

So what makes scheppach stand out from the rest? Firstly, it is equipped with a solid cast iron table and a deep rip fence which locks positively by means of an eccentric clamp. Fit the optional micro fence attachment giving adjustment to 1/10th mm and you are ready for cutting on line – without wandering – down to wafer thin thickness. With up to 300 mm depth of cut; 440 mm throat capacity; two speeds and a table tilt range from minus 20 to plus 47 degrees, all you need in addition is a little imagination.

Instinctive design.

As soon as you set eyes on the Basato 5-2 bandsaw you know instinctively that it is in a class all of its own.



beech



formica



Machine
PROFITIPS/bauen&renovieren 9/98

of the Year
Award

**1st place
Basato 5-2**



plastic



plexiglas



non-ferrous metals

scheppach

saws

Basato 1

Basato 3 vario

Basato 5-2



Basato 1



Basato 3 vario



Basato 5-2

Accessories

For Basato 5-2

Wheel base
consisting of
Elevator
Order No. **6247 0706**
Wheel set with
hook-in console
Order No. **7324 0701**

Belt sanding attachment
Order No. **7324 0240**

Sanding belts (5 pc. 60 grit)
Order No. **7324 0245**

Sanding belts (5 pc. 120 grit)
Order No. **7324 0246**

Crosscut/mitre gauge
Order No. **5320 6200**

Fine adjustment for
ripping fence
Order No. **5410 7800**

Table length extension
Order No. **7324 0170**

Circular cutting attachment
Order No. **7324 0230**

For Basato 3 vario

Base unit
1,050 mm working height
Order No. **7319 0709**

Crosscut/Mitre gauge
Order No. **7312 0025**

Set of sanding belts
3 pieces each
grit 60
Order No. **7319 0711**
grit 120
Order No. **7319 0712**

	<p>Stable, torsion resistant steel construction, swivelling cast iron table, ripping fence with magnifying glass, tempered 3-roller precision saw blade-guide top and bottom, bandwheels with rubber facing, balanced and polished suction connector</p>	<p>Swivelling, large cast iron table top, ripping fence with magnifying glass, continuous adjustable speed control, tempered 3-roller precision saw bladeguide top and bottom, band wheels with rubber facing, balanced and polished, suction connector</p>	<p>Stable, torsion resistant steel construction, swivelling cast iron table, ripping fence with magnifying glass, 3-roller sawblade guide top and bottom, band wheels with rubber facing, 2 speeds, suction connector, push stick, assembly tool</p>		<p>Standard equipment</p>
	CE, GS, Wood dust tested	CE, GS, Wood dust tested	CE, GS, Wood dust tested		Test certificates
	<p>475/440/720 300 x 300 310 45 200 1,490 3,5 to 12 1,480 100 / 195 100 28</p>	<p>860/600/1,680 548 x 400 520 -17 to +45 315 2,360 3.5 to 15 370/750 160/306 100 69</p>	<p>1,230/800/1,870 640 x 640 900 -20 to +47 450 3,430 6-25 460/1,200 300/440 100 154</p>		<p>Technical data l/b/h mm Table size mm Table height mm Table adjustment ° Blade wheel ø mm Sawblade length mm width (min.-max.) mm Cutting speed m/min Clearance height/width mm Suction connector ø mm Weight approx. kg</p>
	<p>220-240 V/50 Hz 0.3 (0.41) 0.24 (0.33) S1 1,480 no yes yes</p>	<p>220-240 V / 400 V / 50 Hz 50 Hz 0.8 (1.1) 0.7 (1.0) 0.55 (0.75) 0.55 (0.75) S1 S1 1,400 1,400 yes yes yes yes</p>	<p>220-240 V / 400 V / 50 Hz 50 Hz 2.3 (3.1) 2.9 (4.0) 1.5 (2.0) 2.2 (3.0) S6 40 % S6 40 % 1,400 1,400 no no yes yes yes yes</p>		<p>Motor Input kW (HP) Output kW (HP) Manufacturing type Speed rpm Brake Motorguard Switch/plug unit with no-volt release</p>
	7322 0901	7319 0901 7319 0902	7324 0901 7324 0902		Order No.
		<p>Professional accessory pack consisting of Circular cutting device for 6 mm sawblade, minimum ø 35 mm, maximum ø 265 mm Depth stop continuous setting of cutting depth from 0 to 200 mm for slots and tenons Sanding belt attachment sanding belt grit 60 Order No. 7319 0710</p>			

schepach

scrolls

deco 401

deco 402

deco-tronic

ds 403

New standards for model and hobby – the scroll saws deco 401, deco 402, deco-tronic and ds 403 vario.

Precise or intricate cuts in wood, plastic metal, Plexi-glas or plaster are challenges faced by those making models and handicraft workers. With schepach scroll saws you can meet any challenge with confidence.

With sturdy parallel arm cutting a straight line is easy but the flexibility of our ds range of scroll saws becomes apparent when intricate and precision work is required – even when

working to millimetre tolerances. A built in fan removes dust particles from the line of cut and the transparent blade guard allows maximum safety without impeding the work. Dual sawblade brackets accept blades with or without pins. Blade changing is quick and simple.

A well angled saw table.

For angle cuts the saw table can be adjusted up to 45 degrees. The deco 402 incorporates a precise angle scale and has the added advantage of two cutting speeds. With the ds 403 vario you decide the cutting speed which is variable from 500 to 1600 cuts

per minute. You also have other functions under control from its user friendly control panel. The ds 403 vario table tilts to 45 degrees on both sides.

Cutting NE-Metall



Internal cuts



Externals cuts



Problem free blade changing.



The saw table can be adjusted from 0 to 45 degrees.



- deco 401
- deco 402
- deco-tronic
- ds 403



deco 401



deco 402



deco-tronic



ds 403 vario

Standard equipment	Stable parallel arm, fan unit, transparent sawblade guard and workpiece holder, plane, machined aluminium table, quick-clamping lever, suction connector, sawblades, sawblade box	Stable parallel arm, fan unit, transparent sawblade guard and workpiece holder, plane, machined aluminium table, quick-clamping lever, suction connector, sawblades, sawblade box	Stable parallel arm, fan unit, transparent sawblade guard and workpiece holder, plane, machined aluminium table, quick-clamping lever, suction connector, sawblades, sawblade box	Stable parallel arm, adjustable table, fan unit, transparent sawblade guard, quick-clamping lever, dual sawblade brackets, variable speeds, control panel, flexible work light, suction connector, sawblades
Test certificates	CE	CE	CE	CE, GS
Technical data l/b/h mm Table size mm Table adjustment ° Sawblade length mm Stroke speed rpm R&F range mm Cutting height/depth mm Suction connector ø mm Weight approx. kg	620/320/320 ø 250 x 410 +45 133 1,450 14 50/400 35 15	620/320/320 ø 250 x 410 +45 133 900/1,450 14 50/400 35 15	650/230/320 ø 250 x 410 +45 133 400 – 1,600 14 50/400 35 12	665/310/400 ø 320 x 415 –45 to +45 133 500/1,600 19 50/406 32 16
Motor Input W	230 V/50 Hz 150	230 V/50 Hz 150/200	230 V/50 Hz 90	230 V/50 Hz 120
Order No.	8800 1904	8800 1905	8800 1906	8800 0003

Sawing
Scroll saws

Accessories

<p>Pin sawblades 6 pcs for wood, plastic, metal, plaster Order No. 8800 0011</p> 	<p>Round sawblade 12 pieces for wood Order no. 8800 1509</p> 	<p>Sawblades 12 pieces for thick soft wood, thin hard wood, multiplex, thick hard wood 133/1,25/0,45 mm, 11 teeth Order no. 8800 2702</p>	<p>Sawblades 12 pieces for plywwod, soft wood, multiplex, thin hard wood 133/0,82/0,36 mm, 16 teeth Order no. 8800 2704</p>
<p>Pin sawblades 6 pcs for wood, plastic, plaster Order No. 8800 0012</p> 	<p>Universal kit 5 x 12 pieces for different materials Order no. 8800 0010</p>	<p>Sawblades 12 pieces for soft wood, thin hard wood, multiplex, thick hard wood 133/0,97/0,40 mm, 13 teeth Order no. 8800 2703</p>	<p>Sawblades 12 pieces for plywood, thin soft wood 133/0,62/0,29 mm, 20 teeth Order no. 8800 2705</p>
<p>Pin sawblades 6 pcs for wood Order No. 8800 0013</p> 	<p>Sawblades 12 pieces for general work, very robust 133/1,16/0,43 mm, 8 teeth Order no. 8800 2701</p>		

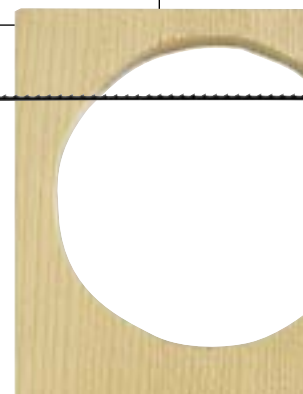

scheppach

planes

hms 2600ci

Whether stationary or mobile: the scheppach hms 2600ci is the most efficient and cost effective planer & thicknesser available for the professional user; serious home woodworkers and educational workshops.

Perfect planing results are guaranteed. See opposite for details of scheppach's unique patented feed and cutting system, which ensures the best possible finish irrespective of the timbers used. Feed roller indentation marks are totally eliminated and the moderately set feed speed of 5m/min combined with 13000 cuts per minute guarantee the best finish by far compared to any other machine in its class.

These special features are enhanced by superb power and stability.

Cast iron tables and powerful motor supply add to the outstanding performance of this robust classic machine.

Adjustment of the thickness table height can be set to within 1/10th mm allowing for a "super-fine" final finish. Perfect when you are working on wild grain timbers!

The new scheppach "ci" planer series sets new standards in both innovation and traditional manufacturing quality.

Ten scheppach advantages which speak for themselves:

- 1. Solid cast iron planing & thicknessing tables** are the heart and soul of the new "ci" models.
- 2. Twin feed rollers vulcanised with a thick rubber sleeve** totally eliminate every trace of indentation marks when thicknessing. (See illustration on page 35).
- 3. Four strong threaded trapeze spindles** ensure accurate and **easy rise and fall adjustment** of the thicknessing table. A final adjustment to 1/10th millimetre over
- 4. Unique clutch mechanism to feed rollers** (not hms 2600ci) offers safety protection and the possibility to disengage feed rollers when surface planing.

New!

Top features!

- **Heavy duty machined CAST IRON tables**
(Easily and accurately adjustable)
- **Large professional planing fence**
(can be adjusted from 0° to 45°)



The hms 2600ci with base unit in thicknessing mode.

Whether you are looking for the best working capacity combined with best quality finish or economical price: **you get it all with the new scheppach hms 2600ci.**



Massive thicknessing capacity: 250 x 210 mm (10 x 8 1/4")



hms 3200ci

- 5. **Continuous chip removal adjustment** when planing together with the accurately machined cast tables ensure utmost planing accuracy.
- 6. **The exceptionally large tilting planing fence**, tiltable up to 45° is ideal for optimum guidance of the workpiece.
- 7. **Micro safety switch** offers maximum safety protec-

tion against inadvertent engaging of the machine when thicknessing before extraction hood is locked in position.

- 8. **Integrated suction system** for both surface planing and thicknessing modes ensures compliance with Health & Safety requirements in the workplace.
- 9. **Compliance with "CE", "GS Safety Tested" and**

"GS Wood Dust Tested" safety requirements guarantees adherence to all safety regulations for both employer and employee in the working environment.

- 10. **Powerful induction motors** (single and three phase) allow chip removal even up to 5mm.

Professional specification coupled with scheppach innovations – the hms 3200ci planer & thicknesser.



New features!

- **Heavy duty machined CAST IRON tables**
(Easily and accurately adjustable)
- **Large professional planing fence**
(can be adjusted from 0° to 45°)

All the performance features of the hms 2600ci planer which guarantee a finish which is unsurpassed by any other similar machine are found in the new scheppach hms 3200ci. With a 320 mm planing width capacity, this machine is more than suitable for the professional workshop. Heavy duty machined cast iron tables to both surface planer and thicknesser enhance its professional capabilities.

The unique feed system with its automatic cut-off drive incorporates twin feed rollers that are vulcanised with a heavy rubber sleeve. It guarantees a continuous feed rate of 5 m/min even with damp timbers. The folding rear cast iron surface planing table with its corrosion free surface, incorporates a large adjustable tilting fence.

The volume of stock removal is determined by an accurate scale indicator with the facility to work within 1/10th of a millimetre which makes the machine perfect when working with difficult timbers.

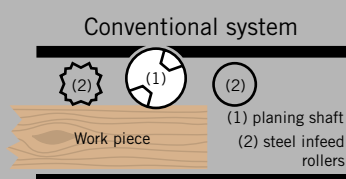

Serrated in-feed roller leaves indentation marks in the workpiece.
Thickness planers equipped with serrated in-feed pressure rollers always leave indentation marks in the workpiece which have to be removed by sanding. If not removed, the ripples left by the feed roller is exaggerated when the wood is painted or varnished.
The patented scheppach system eliminates

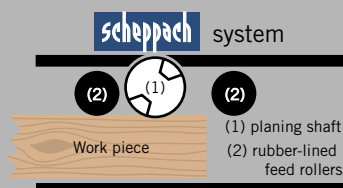

roller indentation marks and offers other advantages found only on a scheppach planer.
scheppach planers are equipped with thick rubber sleeves which are vulcanized on to the twin feed rollers. The system totally eliminates every trace of indentation marks which are common with other planers. With the possibility of adjusting the thickness table to within 1/10th mm a

super fine finishing cut is possible giving the best finish even on wild grain timbers. By positioning the feed rollers immediately adjacent to the cutterblock, pieces as small as 100 mm (4") can be thicknessed. It is even possible to thickness down as thick as 3 mm (1/8"). With a simple jig it is possible to thickness down to 1 mm!
No other planer gives you the scheppach finish.



hmc 2600ci

The basic unit of the schep-
pach Combi System – the hmc
2600ci planer.

The scheppach Combi Sys-
tem is without competition
in its machine category,
which is also true in respect
of the performance of the
basic planing and thick-
nessing machine. At the
heart of this machine lies a
solid balanced cutterblock
seated in maintenance free
sealed ball bearings with
knives which are quickly and
accurately adjustable along
the total width of the cut-
terblock. This perfectly bal-
anced cutterblock shaft also
forms the driving system for
Combi attachments which
are driven independently
by a twin belt colour coded
drive system with braking
device. Two drive speeds are
available allowing the cut-
terblock to work at 6,500
rpm, and the attachments
at 3,000 or 6,500 rpm
according to suitability of
the attachment and/or the
project in hand.

**Unbeatable in-feed drive sys-
tem.** Like all scheppach
“ci” series planers, this
machine incorporates the
unique drive system of
twin rollers with heavy duty
vulcanised rubber sleeves
(see bottom of page 35).
This patented system

New features!

- **Heavy duty machined CAST IRON tables**
(Easily and accurately adjustable)
- **Large professional planing fence**
(can be adjusted from 0° to 45°)



*hmc 2600ci in surface planing mould.
Thickening mode is achieved by rais-
ing the rear planing table.*

guarantees an unbeatable
finish irrespective of the
type of wood being used.
This is further enhanced by
a constant 5 m/min feed
rate and 13,000 cuts per
minute. Stock removal when
surfacing is via a scale with

viewing window. Thanks to
integrally mounted ejection
chutes for both surface plan-
ing and thickening, maxi-
mum extraction efficiency
is achieved; even more so
when linked to a scheppach
purpose built extractor.

The basic planers hmc 2600ci
and hmc 3200ci have in
common the small letter “c”.
It stands for “Combi” and
means that both machines
can easily be extended
for mortising or moulding
by fitting the correspond-
ing attachments. The most

important advantages of a
hmc combi planing machine
are:
– You work like a professional
woodworker, even in the
smallest workshop, as
important features of wood-
working are combined in one
machine.

- **The schepbach combi system is inexpensive,** compared to the purchase price of several stationary machines.
 - **Quick and simple conversion of the attachments** is a matter of course.
 - **A vast range of accessories** allows you to do jobs that otherwise can only be done by professional woodworkers.
- This combi system has been introduced to the market more than 30 years ago and has been successful ever since.**

New features!

- **Heavy duty machined CAST IRON tables**
(Easily and accurately adjustable)
- **Large professional planing fence**
(can be adjusted from 0° to 45°)

Longer tables and bigger working capacity – the basic Combi planer hmc 3200ci.

The schepbach hmc 3200ci is constructed on the same principles as the hmc 2600ci. When not in use the attachments can be stored conveniently on our wall mounted space-saving consoles. Like all machines in the “ci” series, the feed rollers can be disengaged by a conveniently placed clutch lever when surface planing, or as an added safety measure when thicknessing.

Simple or complex tasks: whether operating the basic machine or performing more complex tasks such as spindle moulding and mortising, the hmc 3200ci offers you more than sufficient power plus the choice of the correct working speed. Professional users will particularly appreciate the 1,320 mm long cast iron surface planing tables and the 310 x 180 mm thicknessing capacity. With the additional advantage of being able to add slot mortising and spindle moulder attachments, the hmc 3200ci Combi planer is without rival. And if workshop space is at a premium a wheel kit – as a part of the standard equipment – will resolve that problem.



The hmc 3200ci shown with optional slot mortising attachment lbe 16.

A powerful drive system enables the planing machine and optional attachments of operate separately.



schepach

planes

hms 2600 ci

hms 3200 ci

hmc 2600 ci

hmc 3200 ci

New!



hms 2600 ci



hms 3200 ci



hmc 2600 ci



hmc 3200 ci

Standard equipment	<i>Powder-coated base, surfacing tables and thickening table made of grey cast iron, discharge table tiltable, planing fence adjustable and tiltable, rubber-lined feed rollers, cutter block with two HSS planing knives, integrated discharge hood for surface and thickening planing, tool for knife changing a part of standard equipment</i>		<i>Powder-coated base, surfacing tables and thickening table made of grey cast iron, discharge table tiltable, planing fence adjustable and tiltable, rubber-lined feed rollers, disconnectable feed rollers, cutter block with two HSS planing knives, integrated discharge hood for surface and thickening planing, tool for knife changing part of standard equipment</i>		<i>Powder-coated base, surfacing tables and thickening table made of grey cast iron, discharge table tiltable, planing fence adjustable and tiltable, rubber-lined feed rollers, disconnectable feed gearing, separate two-belt drive for cutter block / attachment, cutter block with two HSS planing knives, integrated discharge hood for surface and thickening planing, tool for knife changing part of standard equipment</i>		<i>Powder-coated base, surfacing tables and thickening table made of grey cast iron, discharge table tiltable, planing fence adjustable and tiltable, rubber-lined feed rollers, disconnectable feed gearing, separate two-belt drive for cutter block / attachment, cutter block with two HSS planing knives, integrated discharge hood for surface and thickening planing, tool for knife changing part of standard equipment</i>	
Test certificates	CE, GS, Wood dust tested		CE, GS, Wood dust tested		CE, GS, Wood dust tested		CE, GS, Wood dust tested	
Technical data								
Dimensions L/W/H mm	1,160/700/970		1,460/850/960		1,160/700/960		1,460/850/960	
Surfacing table size mm	1,040 x 310		1,320 x 380		1,040 x 310		1,320 x 380	
Table height	820		820		820		820	
Thickening table size	430 x 250		590 x 310		430 x 250		590 x 310	
Drive speed								
Plane shaft rpm	6,500		6,500		6,500		6,500	
Attachment rpm					3,000/6,500		3,000/6,500	
Feed speed m/min	5		5		5		5	
Suction connector	100		100		100		100	
Weight approx. kg	135		202		174		212	
Planing data								
Surface planing:								
Plane width mm	260		320		260		320	
Max. Stock removal mm	3		5		3		5	
Thickening:								
Clearance height/width mm	210/250		180/310		140/250		180/310	
Max. stock removal mm	5		5		5		5	
Motor	220-240V/ 50 Hz	400 V/50 Hz	220-240V/ 50 Hz	400 V/50 Hz	230-240V/ 50 Hz	400 V/50 Hz	230-240V/ 50 Hz	400 V/50 Hz
Input kW (HP)	2.5 (3.4)	2.5 (3.4)	2.7 (3.7)	3.8 (5.2)	2.7 (3.7)	3.8 (5.2)	2.7 (3.7)	3.8 (5.2)
Output kW (HP)	1.8 (2.5)	1.8 (2.5)	2.0 (2.8)	3.0 (4.1)	2.2 (3.0)	3.0 (4.1)	2.2 (3.0)	3.0 (4.1)
Rpm	2,800	2,800	2,800	2,840	2,800	2,840	2,800	2,840
Brake	no	no	yes	yes	yes	yes	yes	yes
Motor protection	yes	yes	yes	yes	yes	yes	yes	yes
Switch/plug unit with no-volt release	yes	yes	yes	yes	yes	yes	yes	yes
Order No.	7137 0901	71370902	7136 0905	7136 0906	6236 0901	6236 0902	6241 0901	6241 0902

hms 2600 ci

hms 3200 ci

hmc 2600 ci

hmc 3200 ci



Accessories

For hms 2600 ci

Wheel base uni-drive 300
Order No. 8800 1941



For hms 3200 ci

Wheel base
Order No. 6241 5000

For hmc 2600

Wheel base
Order No. 6029 0000

For hms 2600 ci, hmc 2600 ci

HSS planing knives
2 knives
Order No. 6200 4134

TCT planing knives
2 knives
Order No. 6100 4135

Disposable HSS planing knives
2 knives
Order No. 6023 2200

Knife holders
2 knives
Order No. 6023 2100

For hms 3200 ci, hmc 3200 ci

HSS planing knives
2 knives
Order No. 6241 3500

TCT planing knives
2 knives
Order No. 6241 3600

Disposable HSS planing knives
2 knives
Order No. 6023 4200

Knife holders
2 pieces
Order No. 6023 4100

Knife holders
2 knives
Order No. 6023 4100

For hmc 2600 ci, hmc 3200 ci

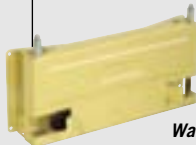

Wall console
as attachment holder for all attachments in the scheppach Combi-System.
Order No. 7943 0000

For hms 2600ci, hms 3200 ci, hmc 2600 ci, hmc 3200 ci

Anti-corrosion agent
Spray, 300 ml, CFC-free
Order No. 6100 9800

Pharmol HEK
Resin removal concentrate
Order No. 6100 9700



Pharmol
Dry lubricant spray 400 g, for enabling smooth gliding of workpieces over the planing tables.
Order No. 6100 9500





Ibe 16

Mortising is essential to satisfy high quality joinery. This is possible with the Ibe 16 mortising attachment.



Mortising attachment

Combi System

No hole in your budget when you add the Ibe 16 mortising attachment.



The Scheppach Combi Ibe 16 slot mortising attachment provides a low cost solution to your mortising problem.

The most striking feature is its ease of operation thanks to a four point locking system which enables attachments to simply "drop and lock" into position. The Ibe 16 has dual levers for maximum control when cutting precise mortise joints. The large work table with accurate round bar guiding mechanism and generous

adjustment range ensures efficient, precise mortising and drilling.

The right setting. Height adjustment couldn't be simpler as this works in conjunction with the rise and fall of the thickening table. End stops can be set for both longitudinal and latitudinal movement. The precision chuck is tightened by means of the standard chuck key.

Standard equipment
Adjustable, corrosion-free table, jig, clamping device, suction connector

Test certificates CE, GS

Technical data
l/b/h 640/450/510 mm
Table size 385 x 190 mm
Table adjustment length /width 120/110 mm
Drill bit cone B 18
Chuck capacity 3-16 mm
Speeds 3,000/6,500
Suction connector \varnothing 100 mm

Order No. **6331 0000**



Accessories

Set of slot mortising bits
For each set: diameters \varnothing 6, 8, 10, 12, 14, 16 mm
Order No. **6330 4000**

Slot mortising bits
SP steel with 2 straight cutter and chipbreaker grooves.

\varnothing 6 mm
Order No. **6330 4001**

\varnothing 8 mm
Order No. **6330 4002**

\varnothing 10 mm
Order No. **6330 4003**

\varnothing 12 mm
Order No. **6330 4004**

\varnothing 14 mm
Order No. **6330 4005**

\varnothing 16 mm
Order No. **6330 4006**



Professional tenoning and artistic projects are evidence of the work you can do on the tfe 30.



tfe 30

The performance of a dedicated spindle moulding machine. The tfe 30 spindle moulder attachment.

The main “building blocks“ of the tfe 30 spindle moulding attachment are exactly the same as the scheppach hf 3000 ci spindle moulding machine. Hence, the table dimensions, tooling capacity and clamping height are both the same. The fence system is also harmonised so the tfe 30 has the same micro adjustments and swivelling protection cover making it possible to change

tooling without disturbing pre-set fence positions.

Total power transmission.

The solid main spindle with its generous bearings plus the unique belt transmission system guarantee the highest possible performance when using the tfe 30 – whatever the task at hand. Soft or hard timbers make no difference to its performance level. A series of table

insert rings and extraction connection piece complete the standard equipment. Simply choose the required tooling and be amazed at what you can do with this unique attachment.



Standard equipment
Corrosion-free table top, height adjustable moulding fence with individually adjustable aluminium impact rails, exchangeable table insert rings, suction connector.

Test certificates CE, GS

Technical data
L/W/H 615/450/590 mm
Table size 615 x 450 mm
Table opening \varnothing 112/135 mm
Spindle \varnothing 30 mm
Height adjustment 60 mm
Speeds 3,000/6,500 rpm
Tool hole 30 mm,
Max. tooling 200 mm \varnothing ,
chuck height 100 mm,
suction connector \varnothing 100 mm

Order No. 6323 0000

The tfe 30 spindle moulder attachment with sliding table carriage inclusive of tenoning table and clamp.



Accessories

Sliding table carriage
Ball bearing guides, tiltable fence 2 x 45° with clamping device, folding rails, guide rails 1,200 mm with base profile for pin milling and for moulding short pieces.
Order No. 7954 0000



Curved moulding fence
3 distance rings, replaceable with continuous fine adjustment.
Order No. 7929 0000

for further accessories see hf 3000 ci on page 46–49

scheppach

moulds

hf 3000ci

Spindle Moulder

**He who has the choice,
chooses precision –
the vertical spindle moulder
hf 3000ci.**

The correct speed and the precisely set tool field an optimum moulding result without the need of refinishing work.

The scheppach hf 3000ci offers three different speeds; the speed set is shown on the electric rpm display. Precision is a matter of setting. The standard moulding fence, adjustable on both sides, can be set to the tenth of a millimetre. The precise adjustment of the moulding spindle is done by means of a hand wheel shown on a scale. A precision sliding table carriage with clamping device and tenoning attachment is offered as optional equipment. Using the corresponding profile cut-

Safety

✓ meets the latest safety regulations and standards (EN 848-1)

ters, the standard clockwise and anti-clockwise spindle rotation allows you to work the wood above the moulding tool. This is a safety feature, just as the standard motor brake.

Clean moulded work pieces are the result of user skill and professional equipment. Using scheppach even laminated boards receive the best possible finish.

New!





hf 3000 ci



ci Series

- Heavy duty machined CAST IRON table

Do not put a limit to your creativity.

Through new technical features and the sensitivity for new top-quality products from professional suppliers, in the course of the years we have acquired a vast accessory range unique in the field.

Thanks to a stop rail, sliding table carriage and table length extension, large-sized moulding jobs are no problem. For varying moulding settings, scheppach offers a set of table insert rings. Thanks to the attachment possibility, work at the hf 3000ci can also be facilitated with a power feed device.

The hf 3000 ci with optional sliding table carriage and tenoning device.

The optional tenoning cutting device allows you to work within 1/10th mm accuracy.



hf 3000ci



hf 3000ci

Accessories

Standard equipment	Cast iron table plate, height adjustable moulding spindle with clockwise and anti-clockwise rotation, moulding fence with individually adjustable fence rails, exchange-able table insert ring, electrical rpm indicator, suction connector																																					
Test certificates	CE, GS																																					
Technical data	<table border="0"> <tr> <td>Dimensions l/w/h mm</td> <td colspan="2">640/660/1,050</td> </tr> <tr> <td>Table size mm</td> <td colspan="2">640 x 480</td> </tr> <tr> <td>Table height mm</td> <td colspan="2">880</td> </tr> <tr> <td>Table opening ø mm</td> <td colspan="2">115/142</td> </tr> <tr> <td>Spindle ø mm</td> <td colspan="2">30</td> </tr> <tr> <td>Spindle height adj. mm</td> <td colspan="2">100</td> </tr> <tr> <td>Spindle speed rpm</td> <td colspan="2">3,000/6,000/9,000</td> </tr> <tr> <td>Tool hole ø mm</td> <td colspan="2">30</td> </tr> <tr> <td>Max. tool ø mm</td> <td colspan="2">200</td> </tr> <tr> <td>Tool clamping height</td> <td colspan="2">100</td> </tr> <tr> <td>Suction connector ø</td> <td colspan="2">100</td> </tr> <tr> <td>Weight approx. kg</td> <td colspan="2">120</td> </tr> </table>		Dimensions l/w/h mm	640/660/1,050		Table size mm	640 x 480		Table height mm	880		Table opening ø mm	115/142		Spindle ø mm	30		Spindle height adj. mm	100		Spindle speed rpm	3,000/6,000/9,000		Tool hole ø mm	30		Max. tool ø mm	200		Tool clamping height	100		Suction connector ø	100		Weight approx. kg	120	
Dimensions l/w/h mm	640/660/1,050																																					
Table size mm	640 x 480																																					
Table height mm	880																																					
Table opening ø mm	115/142																																					
Spindle ø mm	30																																					
Spindle height adj. mm	100																																					
Spindle speed rpm	3,000/6,000/9,000																																					
Tool hole ø mm	30																																					
Max. tool ø mm	200																																					
Tool clamping height	100																																					
Suction connector ø	100																																					
Weight approx. kg	120																																					
Motor	220-240 V/ 50 Hz	400 V/50 Hz																																				
Input kW (HP)	2.8 (3.8)	2.8 (3.8)																																				
Output kW (HP)	1.8 (2.5)	2.2 (3.0)																																				
rpm	2,800	2,800																																				
Brake	yes	yes																																				
Motor protection	yes	yes																																				
Switch/plug comb. with no-volt release	yes	yes																																				
Order No.	7231 0903	7231 0904																																				

Sliding table carriage

Sliding table carriage run on ball bearings, 480 x 500 mm in anodised aluminium, guide rail with double rod guidance, swivelling fence 2 x 45°, exchangeable fence rails 850-1,500 mm, clamping attachment with locking fence and fine adjustment.
Order No. **7938 0100**

Table Extension

1,000 mm for either table end
Order No. **7324 0170**
Insert stop
for either table end
Order no. **7244 0715**

Wheel base

Order No. **7937 0000**

Overhead roller guard assembly

Order No. **7927 0000**

Power feed device va 220

0.125 kW single-phase speed 2-12 m/min continuously adjustable, 3 rollers, runs clockwise and anticlockwise.
Order No. **6808 0000**

Spindle ring

Order No. **6320 5401**

Cutter guard

Order No. **7923 2000**

Suction connector

for bearing ring and drum sanding attachment
Order No. **7500 3900**

Fence rail

1,350 mm, for sliding table carriage, for fence length up to 2,500 mm.
Order No. **5320 8180**

Power feed device va 320

0.32 kW single-phase Speeds 6/8/10/13 m/min, clockwise/anti-clockwise running, 3 rollers
Order No. **6807 0000**

for sanding operations with drum sanding attachments you must use:

Cutter guard

Order No. **7923 2000**

Suction device

Order No. **7500 3900**

Spindle ring

Order No. **6320 5401**

Drum sanding attachment

ø 60 x 100 mm

Order No. **7930 1000**

PlanoRex drum sanding attachment

ø 60 x 100 mm

Order No. **7930 3500**

PlanoRex drum sanding attachment

ø 80 x 100 mm

Order No. **7930 3000**

Abrasive fabric roll

100 mm x 20 meter

Grit size K 60

Order No. **7930 0701**

Grit size K 80

Order No. **7930 0702**

Grit size K 100

Order No. **7930 0703**

Grit size K 120

Order No. **7930 0704**

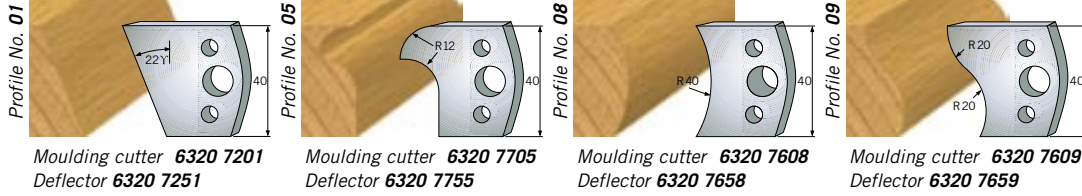

Moulding cutter **6320 7201**
Deflector **6320 7251**



Moulding cutter **6320 7705**
Deflector **6320 7755**



Moulding cutter **6320 7608**
Deflector **6320 7658**



Moulding cutter **6320 7609**
Deflector **6320 7659**



Moulding cutter **6320 7711**
Deflector **6320 7761**



Moulding cutter **6320 7712**
Deflector **6320 7762**



Moulding cutter **6320 7213**
Deflector **6320 7263**



Moulding cutter **6320 7615**
Deflector **6320 7665**

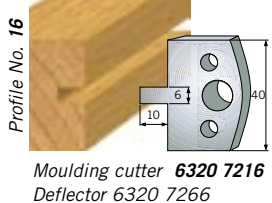

Moulding cutter **6320 7216**
Deflector **6320 7266**



Moulding cutter **6320 7217**
Deflector **6320 7267**

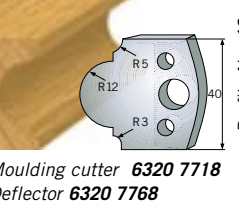

Moulding cutter **6320 7718**
Deflector **6320 7768**



Moulding cutter **6320 7719**
Deflector **6320 7769**



Moulding cutter **6320 7720**
Deflector **6320 7770**

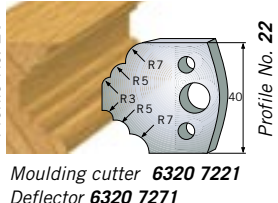

Moulding cutter **6320 7221**
Deflector **6320 7271**

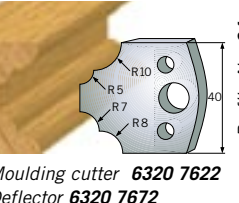

Moulding cutter **6320 7622**
Deflector **6320 7672**



Moulding cutter **6320 7724**
Deflector **6320 7774**



Moulding cutter **6320 7731**
Deflector **6320 7781**



Moulding cutter **6320 7735**
Deflector **6320 7785**



Moulding cutter **6320 7736**
Deflector **6320 7786**



Moulding cutter **6320 7407**
Deflector **6320 7457**



Moulding cutter **6320 7348**
Deflector **6320 7398**

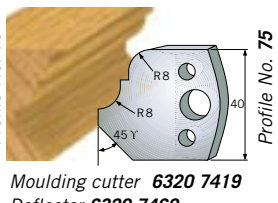

Moulding cutter **6320 7419**
Deflector **6320 7469**



Moulding cutter **6320 7737**
Deflector **6320 7787**

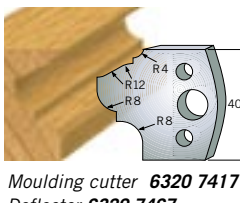

Moulding cutter **6320 7417**
Deflector **6320 7467**

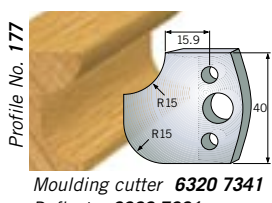

Moulding cutter **6320 7341**
Deflector **6320 7391**

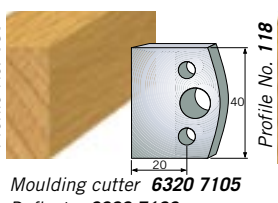

Moulding cutter **6320 7105**
Deflector **6320 7106**



Moulding cutter **6320 7347**
Deflector **6320 7397**

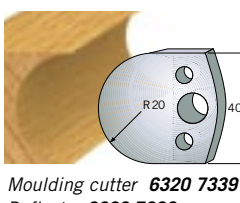

Moulding cutter **6320 7339**
Deflector **6320 7389**

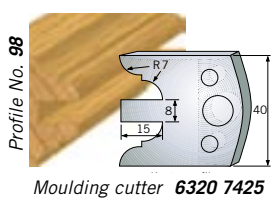

Moulding cutter **6320 7425**
Deflector **6320 7475**

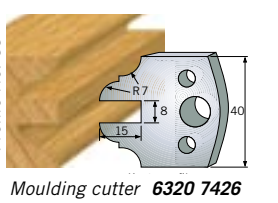

Moulding cutter **6320 7426**
Deflector **6320 7476**

Leading the way in artistic versatility – scheppach profile cutters.

So many possibilities to fulfil your artistic imagination with scheppach's highest quality moulding cutters. The rear sharpened cutters guarantee perfect moulds without traces of burning. Every moulding cutter and matching chip limiter/deflector are so evenly balanced that the cutterhead operates in perfect harmony and without the slightest vibration. Tool adjustment is possible without adjusting the moulding fence settings.



schepach

moulds

hf 3000ci



Spindle moulder tooling

An optimum cutting result can only be achieved by using cutting tools of outstanding quality. schepach offers a range of spindle moulder tooling which is produced from superior quality steel or aluminium. The cutting tools are manufactured with the most modern production technologies and therefore guarantee an outstanding cutting performance in terms of finish quality and lifetime.



Universal safety profile cutter head
tool body in light alloy with 6 pairs of profile knives and 6 pairs of chip limiters in wooden box

Technical data
ø 100 x 40 x ø 30 mm
rpm 5,500 – 8,500

Order no. **7231 0745**

TC Grooving cutters

ø 100/30 mm, Z2
Grooving width 4 mm, steel
Order No. **7231 0740**



Grooving width 6 mm, steel
Order No. **7231 0741**

Grooving width 8 mm, steel
Order No. **7231 0742**

Grooving width 10 mm, steel
Order No. **7231 0743**

Grooving width 12 mm, steel
Order No. **7231 0744**

Bearing ring

for universal safety cutter-head, for curved profile cutters, with 2 exchangeable spindle moulding rings, 92/86 and 106/102 mm, to be used only with cutter guard
Order No. **7923 3000**



Bearing ring set

9 bearing rings, ø 90 – 130 mm, in wooden box,
Order No. **7244 0713**



Spacing washers

Set A =
2 x 0.1, 1 x 0.3,
1 x 0.5 mm
Order No. **6320 5100**



Spacing washers

Set B = 2 x 1.0, 1 x 3.0,
1 x 5.0 mm
Order No. **6320 5200**

Set of push handles

set of 2
Order No. **7963 1000**

Grooving cutter with TC reversible knives

ø 100 / ø 30 mm, T max. 24 mm, Z 2
rpm 8.000 – 12.000
Grooving width 4 mm, steel
Knife type: **5/7****
Order No. **7231 0701**



6 mm, steel
Knife type: **5/8****
Order No. **7231 0702**

8 mm, light alloy
Knife type: **6/1****
Order No. **7231 0703**

10 mm, light alloy
Knife type: **6/2****
Order No. **7231 0704**

12 mm, light alloy
Knife type: **6/3****
Order No. **7231 0705**

Grooving cutter with TC reversible knives

ø 150 / ø 30 mm, T max. 49 mm, Z 4, rpm 5.100 – 8.900, Grooving width 8 mm, light alloy
Knife type: **6/1****



Order No. **7231 0706**
10 mm, light alloy
Knife type: **6/2****
Order No. **7231 0707**
12 mm, light alloy
Knife type: **6/3****
Order No. **7231 0708**

Adjustable grooving cutter with TC reversible knives

tool body in steel
ø 200 x 8 – 15 x ø 30 mm, T max. 75 mm
rpm 4.000 – 6.000
Knife type: **6/1****
Order No. **7231 0709**



Adjustable grooving cutter with spacing circle

tool body in steel, 3 pieces, ø 150 x 4 – 15 x ø 30 mm, T max. 45 mm, Z 4
rpm 5.000 – 8.000
Knife type: **5/7/1****
Order No. **7231 0710**





Rebating cutterhead with TC reversible knives

tool body in light alloy
ø 125 x 50
x ø 30 mm,
Z 2



rpm 6.000 – 10.300
Knife type: **6/4****
Order No. **7231 0711**

Rebating cutterhead with TC reversible knives

tool body in light alloy
ø 100 x 25 x
ø 30 mm,
Z 4



rpm 5.200 – 8.600
Knife type: **6****
Order No. **7231 0712**

Rebating cutterhead with TC reversible knives

with extreme shear angle cut
tool body in light alloy
ø 125 x 44 x
ø 30 mm, Z 2
rpm 6.000
– 10.300



Order No. **7231 0713**
TCT reversible knife
22 x 19 x 2 mm, 10 pieces
Knife type: **9****
Order No. **7231 0730**
49,7 x 11,8 x 1,5 mm,
2 pieces
Knife type: **6****
Order No. **7231 0727**

Adjustable chamfering cutter-head with TC reversible knives

tool body in light alloy
infinitely
adjustable
angle ± 45°,
15° positive
stops



ø 120 x 40 x ø
30 mm, Z 2, ø max. 138 (at
45°), rpm 6.400 – 8.500
Order No. **7231 0714**

TCT reversible knife

40 x 12 x 1,5 mm,
10 pieces
Order No. **7231 0725**

Universal safety profile cutterhead

tool body in light alloy
with 2 SP
rebating
knives and 2
chip limiters
ø 100 x 40 x
ø 30 mm
rpm 5.500
– 8.500



Order No. **7231 0715**
TCT reversible knife
see page 47

Universal safety profile cutterhead

tool body in steel for
knives with cut-
ting width 40
and 50 mm
with 2 SP
rebating knives
and 2 chip
limiters
ø 93 x 40 – 50 x ø 30 mm
rpm 5.800 – 8.600
Order No. **7231 0716**
TCT reversible knife
see page 47



Glue joint cutter with reversible TC blanks

tool body in light alloy
ø 130 x 50 x
ø 30 mm, Z 2
rpm 5.900 – 9.000
Order No. **7231 0717**



TCT reversible knife
50 x 24 x 2 mm, 2 pieces
Order No. **7231 0734**

V glue joint cutter with TC blanks

tool body in light alloy
ø 120 x 50 x ø 30 mm, Z 2
rpm 6.400 –
10.600
Order No. **7231 0718**



TCT reversible knife
50 x 12 x 1,5 mm, 2 pieces
Order No. **7231 0735**

Panel raising cutterhead with TC blanks

tool body in light alloy
ø 180 x
28 x ø 30 mm,
Z 2, rpm 4.200
– 7.200
Order No. **7231 0719**



TCT reversible knife
50 x 25 x 2 mm, 2 pieces
Order No. **7231 0736**

Counter profile cutterhead with TC blanks

tool body in light alloy
ø 120 x 40 x
ø 30 mm, Z 2
rpm 6.400
– 8.400
Order No. **7231 0720**



TCT reversible knife
40 x 26 x 2 mm, 2 pieces
Order No. **7231 0737**

Multi profile cutterhead with TC blanks

tool body in light alloy
ø 120 x 40 x ø 30 mm, Z 2
rpm 6.400 – 10.000 1/min.
Order No. **7231 0721**



TCT reversible knife
40 x 25 x
2 mm, 2
pieces
Order No. **7231 0738**

**** TC reversible knives**

Knife type 1
7,5 x 12 x 1,5 mm, 10 pcs.
Order No. **7231 0722**

Knife type 2
9,6 x 12 x 1,5 mm, 10 pcs.
Order No. **7231 0723**

Knife type 3
11,6 x 12 x 1,5 mm, 10 pcs.
Order No. **7231 0724**

Knife type 4
50 x 12 x 1,5 mm, 10 pcs.
Order No. **7231 0726**

Knife type 5
14 x 14 x 1,2 mm, 10 pcs.
Order No. **7231 0728**

Knife type 6
14 x 14 x 2,0 mm, 10 pcs.
Order No. **7231 0729**

Knife type 7
18 x 18 x 1,95 mm, 10 pcs.
Order No. **7231 0731**

Knife type 8
18 x 18 x 2,95 mm, 10 pcs.
Order No. **7231 0733**



Typ 1-3

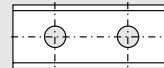

Typ 4



Typ 9



Typ 5/6



Typ 7/8

schepach

sands

bsm 2010

Sanders

Belt sanding machine

The perfect finishing touch – with the bsm 2010 belt sander.

Whatever your sanding project it will be all part of a days work with the schepach bsm 2010 vertical & horizontal sanding machine. In vertical sanding mode the tables offer more than adequate support and the continuous height adjustment enables the full depth of the sanding belt to be used which is extremely cost effective. The generous sanding surface provides safe and efficient sanding of larger workpieces and the belt speed of 11 m/sec eliminates the possibility of overheating and discoloration of the wood.

A handle provides quick and easy adjustment to either horizontal or vertical sanding. Both tables are adjustable to 45 degrees and the standard fence allows you to work safely even with small work pieces.



The continuous table height adjustment allows evenly sanded surfaces and corners.



Assembled pieces can be comfortably sanded in the horizontal sanding mode.



With the optional angle fence you can guide even small pieces safely.



The angle fence can be adjusted to 45 degrees in left and right directions.



Accessories

Stand

l/w/h 1,180/650/710 mm
Order No. **7600 7000**



Angle fence

Order No. **8101 6600**



Set of sanding belts

Linen – 3 pcs each set
K 80
Order No. **8101 7300**
K 120
Order No. **8101 7400**
K 220
Order No. **8101 7500**

Set of sanding belts

Paper – 3 pcs each set
K 80
Order No. **8101 7000**
K 120
Order No. **8101 7100**
K 220
Order No. **8101 7200**

The small diameter of the end roller allows for perfect sanding of inner curves.





bts 900x



Innovation for quick and exact sanding and finishing.

All advantages combined – both belt and disc sanding are provided with the bts 900x. The belt sander unit can be adjusted by 90° from vertical to horizontal position. The sanding table, swinging through 45°, can variably be used for belt and disc sanding. At the cross stop, any angle can be exactly set.

New!



The sanding belt can be continuously adjusted from horizontal to vertical.



The tilting table can be positioned for both belt and disc sanding operations.



The sanding discs are easily attached with the velcro fastening system.



Accessories

Sanding paper set
ø 150 mm, 10 per set
K 80
Order No. **8800 0208**
K 120
Order No. **8800 0209**
K 220
Order No. **8800 0210**

Set of sanding belts
Linen, 100 x 914 mm
3 per set
K 80
Order No. **8800 0211**
K 120
Order No. **8800 0212**
K 220
Order No. **8800 0213**

schepach

grinds

bg 150

bg 200

New!

**Double end grinders –
bg 150 and bg 200.**

Our two dry double end grinders can give rapid sharpening to various types of blades. Powerful motors quickly bring the rough and smooth grinding stones to their required operating speed. With the bg 200 you have the option of up to 550 Watt motor power and its large diameter grinding wheels allows for quick results even with larger tools. Both models come equipped with a safety lamp.



Accessories

For bg 150

Grinding discs

ø 150 x 25 x 12.7 mm

K 36

Order No. **8800 0892**

K 60

Order No. **8800 0893**

For sm 150x

Grinding discs

ø 150 x 19 x 12.7 mm

K 36

Order No. **8800 0214**

K 60

Order No. **8800 0215**

For bg 200

Grinding discs

ø 200 x 25 x 16 mm

K 36

Order No. **8800 0870**

K 60

Order No. **8800 0869**

For sm 200x

Grinding discs

ø 200 x 25 x 16 mm

K 36

Order No. **8800 0870**

K 60

Order No. **8800 0869**

bsm 2010

bts 900x

bg 150

bg 200



bsm 2010



bts 900x



bg 150



bg 200

Standard equipment	<i>Folding sanding plate with workpiece fence, height adjuster, swivel length table, swivel cross table, 3 sanding belts, suction connector, assembly tool</i>		<i>Stable, torsion resistant casing, pivoting work table, horizontally and vertically adjustable sanding belt, sanding discs with velcro fastening, sanding belt, sandpaper, suction connector, assembly tool</i>		<i>Rough and smooth discs, work light (bulb not supplied), adjustable tool plate, assembly tool, water tank</i>		<i>Rough and smooth discs, work light (bulb not supplied), adjustable tool plate, assembly tool, water tank</i>	
Test certificates	CE, GS, Wood dust tested		CE		CE		CE	
Technical data l/w/h mm Grinding plate Length table size mm Cross table size mm Table size mm Table adjustment ° Sanding belt length/width mm Sanding belt grit size Belt speed m/sec Sanding disc speed rpm Disc bore ø mm Suction connector ø mm Weight approx. kg	1,250/520/420 800 770 x 200 480 x 200 45 2,000/150 80/120/220 11		475/365/325 280 x 100 215 x 145 90 – 45 915/100 80 7,5 2850		385/240/280 150/12.7 11,5		440/280/340 200/16 25	
Motor Input kW (HP) Output kW (HP) rpm Motor protection Switch/plug comb. with no-volt release	220–240 V/ 50 Hz 2.7 (3.7) 2.0 (2.7) 2,800 yes yes	400 V/50 Hz 3.6 (4.9) 2.9 (3.9) 2,800 yes yes	230 – 240 V/50 Hz 0,37 2,850 yes yes		230 V/50 Hz 0.37 (0,5) 2,850		230 V/50 Hz 0.55 (0,75) 2,850	
Order No.	8103 0000	8104 0000	8800 1934		8800 1927		8800 1928	

schepach

grinds

TiGer 2000

TiGer 2500

Professional grinding results made simple with the TiGer 2000 and TiGer 2500.

Correct grinding and honing requires skill – unless the efficient technique has already been “built in” your grinder, like with the TiGer 2000.

Only if you grind your knives and tools on a grindstone slowly running in a water trough so that the tool never loses its temper due to overheating, makes it possible to get a lasting sharp edge. The top-quality grindstone with grinding grains of aluminium oxide is part of the standard equipment of each TiGer model.

The TiGer 2000 is ideal for home and the small workshop. It provides all the knives, scissors and tools with perfectly sharp cutting edges.



Professional grinding and honing – TiGer 2500.

The big brother TiGer 2500, too, excels with the qualities of the TiGer 2000 model, so that in a few seconds, thanks to the top-class grindstone with the large diameter of 250 mm. The powerful motor being conceived for uninterrupted

operation, this model is perfect for tradesmen with the daily need for grinding. The ingenious system for finding the correct grinding angle allows maintaining the same angle over many years.





TiGer 2000

TiGer 2500



TiGer 2000



TiGer 2500

Grinders

Wet grinding system

**Australian's
Woodworkers
Choice**

**Statements in technical
magazines**

"... The result, based on the previously executed cold wet-grind, is an actually "razor blade sharp" cutting edge with expectations of a long service life..."

Excerpt from "dds", 3/03, H. Sielaff, Hildesheim)

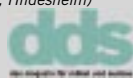

"Definitely convincing: the grinding result, the tool-sparing grinding method and the top quality of machine and grindstone." (Elmar Haag-Schwilk, Senior Editor of "Bauen & Renovieren")



TTTT = very good TTT = good
TT = useful T = not functional

(aus „Selbst ist der Mann“, 4/03)

Standard equipment	Solid, powder-coated casing, splash-proof motor and switch, top-quality grindstone with grinding grains of aluminium oxide, also for HSS tools, removable leather honing wheel, non-skidding support, powerful motor, grinding jig 70, abrasion paste, angle guide, break-proof water tank, 1.75 m long electric cable with splash-proof plug	Solid, powder-coated casing, splash-proof motor and switch, top-quality grindstone with grinding grains of aluminium oxide, also for HSS tools, removable leather honing wheel, non-skidding support, powerful motor for uninterrupted operation, universal support for grinding jigs, abrasion paste, angle guide, solid water tank, 1.75 m long electric cable with splash-proof plug
Test certificate	CE	CE
Technical data L/W/H mm Grinding stone size Stone grid Material Leather honing wheel ø mm Weight approx. kg	360/285/275 200 x 40 K 220 top-quality grindstone with grinding grains of aluminium oxide 200 x 30 13.5	350/360/420 250 x 50 K 220 top-quality grindstone with grinding grains of aluminium oxide 200 x 30 18.5
Motor Input W Rotation speed 1/min	230-240 V/50 Hz 120 120	230-240 V/50 Hz 200 90
Order no.	8949 0901	8949 0902



schepach

grinds

TiGer 2000

TiGer 2500



New!



Jig 25
for retaining clamps and tubes
Order no. **8949 0735**

New!



Jig 380, to be used variably for knives with different width, precise, easy running and maintenance-free guiding by sliding bearings, hard anodized, fine-setting for grinding angles, 400 mm max. grinding length, Order no. **8949 0724**



Jig 320, for use with varying knife widths, especially for jointer and planer blades up to 320 mm, accurate, easy-running and maintenance-free sliding bearing guidance, hard-anodized, grinding angle fine-adjustment
Order no. **8949 0723**



Jig 55 (rough turning and hollow turning tools) used in conjunction with Universal Jig 100 (standard equipment), it provides perfect results on oblique edges and hollow chisels
Order no. **8949 0706**



Jig 40
is the perfect attachment for axes with a blade up to 170 mm
Order no. **8949 0712**



Grinding support 110
for turning scrapers, carving scraps and cabinet scrapers
Order no. **8949 0718**



TiGer 2000

TiGer 2500



Jig 120
is designed for knives with blade length of 100 mm to 200 mm
Order no. **8949 0709**



Stone grader changes the grains on the grinding wheel for fine abrasion
Order no. **8949 0707**



Jig 70 is perfect for straight edges, plane irons, ripping chisels and spoke shave blades
Order no. **8949 0716**



Jig 60
is suitable for small knives with blade length of 40 mm to 100 mm
Order no. **8949 0708**



Stripping device ensuring that the grinding wheel is always perfectly round and level
Order no. **8949 0713**



The angle guide 200/250 is used for measuring exact angles and settings
200: Order no. **8949 0717**
250: Order no. **8949 0704**



Jig 160
is designed for scissors and hedge shears
Order no. **8949 0710**



Leather honing wheel 100 for polishing gouge and V tool surfaces
Order no. **8949 0705**

Extensive accessories included with the standard equipment:

Knives, axes and scissors are not lightly given away for grinding.

If you prefer to sharpen your blades, scissors, axes and chisels yourself – no problem: With the right and vast range of accessories for the TiGer models, you put a sharp edge to all your tools. Thanks to the stripping device and the stone grader, the grindstone is always ready for use and facilitates grinding even after many years. The leather honing wheel, whether profiled or plain, will become an indispensable part of your TiGer. After sharpening, it removes the burr to give you a smooth edge.

Superior technique for long-lasting, perfectly sharp edges.

Accessories

<p>Replacement cutting edge for stripping device Order no. 8949 0714</p>	<p>Wetgrind 2000 Grindstone with grinding grains of aluminium oxide ø 200 x 40 mm Order no. 8949 0715</p>
<p>Abrasion paste Order no. 8949 0703</p>	
<p>Wetgrind 2500 Grindstone with grinding grains of aluminium oxide ø 250 x 50 mm Order no. 8949 0701</p>	<p>Leather honing wheel ø 200 x 30 mm Order no. 8949 0702</p>

schepach

glues

Plano 1100

Plano 1250



Plano

Seamless glued surfaces – schepach Plano glue press.

schepach Plano four way glue press cannot be compared to anything else. A patented internal linkage system guarantees that equal pressure is applied to all four sides of the work project at the turn of a hand-wheel. All gluing problems, such as warping or bowing and unilateral stretching are eliminated. If you want perfect gluing results you have one choice – schepach Plano. Now you can convert separate parts into one large flat, seamless surface just as though they were made from a single piece. The pressure point is always at the centre of the workpiece and the pressure – up to 800 kp – is evenly distributed on all sides.

Use the wall as your working surface. schepach Plano glue press is wall mounted and therefore saves you space. With two presses mounted on the wall rail you can perfectly glue pieces together up to 800 mm in length. For longer lengths just add the number of presses and wall rails according to your work requirement.



A series of Plano glue presses with wall mounted guide rails.

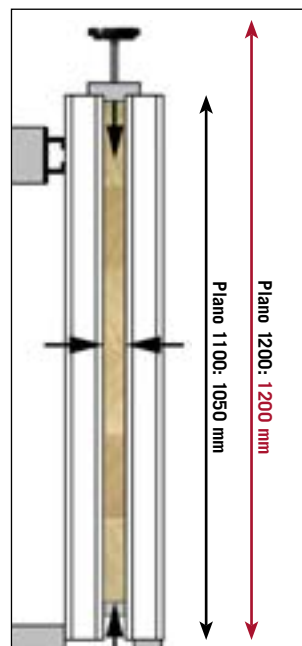

The patented lever system guarantees that equal pressure is distributed on all four sides of the workpieces.

Plano
Patented lever arm system made of aluminium and steel. Max pressure 800 kp

Plano 1100 start set
Including 3 adhesive presses, 1 wall-mounted slide rail l/b/h 35/130/1,120 mm
Max. workpiece height/thickness 1,050/120 mm
Max. workpiece length 1,200 mm
Order No. **8993 0102**

Plano 1100 supplementary set
Including 2 adhesive presses, 1 wall-mounted slide rail
Max. workpiece length 800 mm
Order No. **8993 0101**

Plano 1250
l/b/h 35/130/1,270 mm
Max. workpiece height/thickness 1,200/120 mm
Weight approx. 4.6 kg
Order No. **8993 0100**

Accessories

Wall-mounted rail
1000 mm, for both models
Order No. **8993 2000**

The spindle and tailstock centres are perfectly aligned.



dmt 450

Top features

✓ 445 mm distance between centres

✓ 127 mm height of centres over bed

✓ \varnothing 254 mm turning over bed



The dmt 450 set for longitudinal turning.

Continuous quiet turning – the compact dmt 450 lathe from scheppach.

The scheppach dmt 450 is ideal for the hobby woodturner with a small workshop. It is also most useful for woodturners who are on the move as it is small enough to transport in the boot of a car. The powerful induction motor has high torque capacity to allow for turning of heavy timbers without stalling. The precision machined main drive spindle runs on two industrially rated sealed-for-life bearings to maximize support and has a 1" by 8 tpi thread. The 5 step pulley system with Poly-V belt drive offers a huge speed range: speed change being quick and simple.

For completely satisfying results.



Standard version of the dmt 450.



dms 900

scheppach dms 900 heavy duty lathes with unique clockwise and anti-clockwise rotation.

The scheppach dms 900 woodturning lathe is designed with the committed artisan in mind as well as the professional who requires a machine with an excellent specification at a competitive price. Built of cast iron the dms series lathes are made to last. Powered by a very quiet running, high torque induction motor, it gives ten speeds ranging from 500 rpm 2,100 rpm and is therefore ideal for small diameter spindle work through to large bowl turning.

Both the headstock, tailstock and lathe bed are made from solid cast iron which has been accurately machined to allow for smooth movement and minimal levels of vibration. The pivoting headstock turns 180° and locks to facilitate outboard turning.

Unique to the scheppach dms series is the clockwise and anticlockwise spindle rotation which offers the advantage of positioning the tool rest to the left or right when swiveling the headstock.

The scheppach dms 900 will give satisfaction from the day of purchase and long into the future.



Standard version of the dms 900 with base unit.

Top features

✓ Ten rotation speeds from 500 to 2,100 rpm

✓ Clockwise and anti-clockwise rotation

✓ 180° spindle head rotation

✓ 825 mm distance between centres

✓ 152 mm height of centres over bed



dms 1100

Aimed at the professional or serious enthusiast, the woodturning lathe dms 1100 with standard base.

Woodturning Lathes

Workshop Woodturning Lathe

Top features

- ✓ Ten rotation speeds from 500 to 2,100 rpm
- ✓ Clockwise and anti-clockwise rotation
- ✓ 180° spindle head rotation
- ✓ 1050 mm distance between centres
- ✓ 175 mm height of centres over bed



The dms 1100 set for transverse turning.

Although in many ways similar to our dms 900 this lathe with its much heavier construction and larger 1 HP induction motor will appeal to the professional or committed turner who is looking for that higher specification in a more powerful machine. Distinguished also by its impressive specification, the dms 1100 weighs in at 92 kg and offers 1,050 mm between centres and 355 mm turning diameter over the bed. For those large turning projects it has the advantage of a swiveling headstock. Ten spindle speeds and the advantages of both clockwise and anti-clockwise spindle rotation, the scheppach dms 1100 offers a heavy duty lathe at light duty cost.

dmt 450

dms 900

dms 1100



dmt 450



dms 900



dms 1100

Standard equipment	<i>Stable, torsion resistant grey cast iron construction, plane, polished turning bed, Cast iron spindle stock, tailstock and tool rest, toolrest and tailstock with eccentric clamp, face plate, following centre point, drive centre 4-point, adaptor for M33, 5 spindle speeds, Poly V belt drive</i>	<i>Stable, torsion resistant grey cast iron construction, plane, polished turning bed, cast iron spindle stock, tailstock and tool rest, toolrest and tailstock with eccentric clamp, slewable spindle stock, face plate, drive centre 4-point, following centre point, adaptor for M33, 10 spindle speeds, Poly V belt drive, wise and anticlockwise rotation</i>	<i>Stable, torsion resistant grey cast iron construction, plane, polished turning bed, cast iron spindle stock, tailstock and tool rest, toolrest and tailstock with eccentric clamp, slewable spindle stock, face plate, drive centre 4-point, following centre point, adaptor for M33, 10 spindle speeds, Poly V belt drive, wise and anticlockwise rotation</i>
Test certificates	CE	CE	CE
Technical data			
<i>l/b/h mm</i>	770/285/375	1,510/490/1,120	1,610/490/1,175
<i>Bed height mm</i>	190	890	910
<i>Spindle head thread</i>	1" x 8 TPI	1" x 8 TPI	1" x 8 TPI
<i>Spindle head cone</i>	MK2	MK2	MK2
<i>Tailstock cone</i>	MK2	MK2	MK2
<i>Tailstock bore (hollow spindle) mm</i>	9	9	9
<i>Distance between centres mm</i>	445	825	1,050
<i>Height of centers over bed mm</i>	127	152	175
<i>Sleeve adjustment mm</i>	47	55	55
<i>Spindle speeds rpm</i>	650/1,100/1,450/2,000/3,000	500/600/750/900/1,000/1,200/1,400/1,600/1,800/2,100	500/600/750/900/1,000/1,200/1,400/1,600/1,800/2,100
<i>Turning ø over bed mm</i>	254	304	355
<i>Tool rest length mm</i>	150	300	300
<i>Face plate ø mm</i>	75	150	150
<i>Weight approx. kg</i>	34	80	92
Motor			
<i>Input kW (HP)</i>	230–240 V/50 Hz 0.37 (0.5)	230–240 V/50 Hz 0.55 (0.75)	230–240 V/50 Hz 0.75 (1.0)
<i>Output kW (HP)</i>	0.26 (0.33)	0.34 (0.46)	0.5 (0.68)
<i>rpm</i>	1,360	1,400	1,400
Order No.	8800 1921	8800 1923	8800 1925



dmt 450
 dms 900
 dms 1100

Accessories

for dmt 450, dms 900,
 dms 1100

**Three-jaw
 chuck
 assembly**

100 mm,
 inner capacity 25–87 mm,
 outer capacity 3–93 mm
 Order No. **7400 8900**



**Four-jaw rotary
 chuck assembly**

125 mm, with outer and
 inner jaws, inner capacity
 37–123 mm, outer capacity
 3–93 mm
 Order No. **7400 7400**



Dog plate
 80 mm
 Order No. **7400 8800**



Face plate
 200 mm dia.
 Order No. **7400 7500**



Precision chuck 4496
 Order no. **8800 2709**

Cut chuck
 dia 40 mm
 Order No. **7400 7300**



Drilling chuck
 3–16 mm,
 with conical arbour
 Order No. **7400 7700**

**Grooving
 hook chisel**
 left-hand, 26 mm
 Order No. **7400 7911**



**Round turning
 chisel**
 20 mm
 Order No. **7400 7910**



**Pointed
 turning chisel**
 20 mm
 Order No. **7400 7909**



Turning gouge
 6 mm
 Order No. **7400 7904**



Turning gouge
 10 mm
 Order No. **7400 7905**

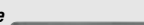

Turning gouge
 20 mm
 Order No. **7400 7801**

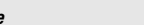

Turning gouge
 30 mm
 Order No. **7400 7906**



**Flat turning
 chisel 6 mm**
 Order No. **7400 7907**



**Flat turning
 chisel 16 mm**
 Order No. **7400 7803**



**Flat turning
 chisel 26 mm**
 Order No. **7400 7908**

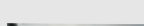

Ripping chisel
 5 x 15 mm
 Order No. **7400 7802**

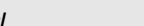

HSS tool set, 5-fold
 250 mm overall length,
 150 mm handle length, con-
 sisting of 3/6 mm hollow
 turning chisel, 6 mm flat
 chisel, 4 mm pointed chisel,
 2.5 mm plug chisel
 Order no. **8800 2716**

Roughing tool
 fine casting,
 HSS quality, 10 x 10 mm,
 face plate copying tracer
 Order No. **7971 5005**

Pointed tool
 copying tracer
 fine casting,
 HSS quality, 10 x 10 mm,
 single reference
 Order No. **7971 2016**

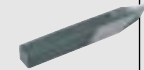

Tracing roller
 for tossing
 and roughing tools
 Order No. **7971 5100**



Tossing tool
 fine casting, HSS quality,
 (only with tool holder,
 Order No. **7971 5200**
 for use in
 rough turning)
 Order No. **7971 5204**



Turnover cutting tool
 fine casting, HSS quality,
 (only for use with tool holder,
 Order No. **7971 5200**)
 Order No. **7971 5203**



Tool holder
 for tossing tool
 and turnover
 cutting tool
 Order No. **7971 5200**



Template blank
 990 x 90 x 3mm
 Order No. **7971 0018**

Copying device 1000
 suitable for dms 900/1100,
 dmt 180, dmv 200
 Order no. **8800 2707**
 Delivery from week 25

scheppach

drills

rab t16x

rab s16x

The answer to your drilling problems – the rab t16x and rab s16x radial drill presses.

With the radial drill presses, scheppach brings the position of the drill exactly where you want it. They can be angled, extended, and positioned in all manner of directions. With the rab t16x the table is adjusted by hand crank whilst the spindle is set via a toothed rack. The rab s16x is a floor standing model with a table pivoting through 360 degrees.

Top Features

✓ Quick-lock chuck comes as standard

✓ 5 speeds available

✓ Strong motor of 550 Watt power

✓ Chuck guard fitted as standard



The clearance between spindle and column can be adjusted from 165 mm to 330 mm – the table height being adjustable.



The cast iron table can be tilt in both directions up to 45 degrees.



The machined extensions of the rab drills swing to both sides.



With all rab models the drilling speed is controlled by pulleys.



The table of the rab s16x can be pivoted through 360 degrees.



rab t16x

rab s16x



rab t16x



rab s16x



rab t13x

Standard equipment	<i>Radial drill press with angle adjustment, height adjustable and tilting cast iron table top, solid base plate, machined extension arm, adjustable drilling depth stop with scale, chuck guard, quick lock chuck</i>	<i>Radial drill press with angle adjustment, height adjustable and tilting cast iron table top, solid base plate, machined extension arm, adjustable drilling depth stop with scale, chuck guard, quick lock chuck</i>	<i>Radial drill press with angle adjustment, height adjustable and tilting cast iron table top, solid base plate, machined extension arm, adjustable drilling depth stop with scale, chuck guard, quick lock chuck</i>
Test certificates	CE	CE	CE
Technical data Dimensions l/w/h mm Table size mm Chuck clamping range mm Cone seat spindle Cone seat drill chuck Spindle travel mm Spindle speeds rpm Dist. spindle/column mm Extension arm radial adjustment mm swinging range ° Table swinging range ° Dist. table/chuck mm Dist. foot/chuck mm Column dia. mm Extension arm dia. mm Weight kg	850/320/1,690 255 x 255 3-16 MK 2 B 16 80 460/730/1,130/1,670/2,480 115-435 320 left/right 60 left/right 45 max. 685 max. 1,235 70 59.5 63	840/320/935 195 x 195 3-16 MK 2 B 16 80 460/730/1,130/1,670/2,480 125-445 320 left 70, right 60 left/right 45 max. 365 max. 485 59.5 59.5 37	740/270/710 220 x 190 1-13 MK 2 B 16 100 500/890/1,400/1,900/2,500 100-340 240 left 45/right 70 left/right 45 max. 180 max. 260 48 32 30
Motor Input W	230 V/50 Hz 550	230 V/50 Hz 550	230 V/50 Hz 450
Order No.	8800 1909	8800 1908	8800 1907

schep-pach

supports

rb

kb

asr



As useful as an extra pair of hands – schep-pach roller stands.

To achieve the best results with minimum expenditure of energy but increased safety – you need a schep-pach roller stand. They will prevent you having to call for help when working on those awkward heavy pieces or large panels. Three different models are available.

One with a single straight roller which can support up to 120 kg; one with ball bearings for lateral movement and one which is designed for lateral movement without any possibility of scuffing work surfaces such a melamine.

Roller stand rb
Rollers 50 x 400 mm
Continuous height adjustment from 550–910 mm
Max. load 120 kg
Order No. 7901 0000

Roller stand kb
With ball elements
53 x 430 mm
Continuous height adjustment from 670–1,030 mm
Max. load 100 kg
Order No. 7902 0000

Multidirection roller stand asr
Extremely smooth running plastic roller stands
48 x 390 mm
Continuous height adjustment from 690–1,010 mm
Order No. 7904 0000



The rb roller stand can support weights up to 120 kg.

The ball bearing of the kb roller stand allow for lateral movement.

The asr roller stand is ideal for timbers and surface coated boards.-



ha 2000

Great in keeping the working environment clean – the “small” dust extractor ha 2000.



Top Features

- ✓ 800 m³/h air capacity
- ✓ Low noise level
- ✓ Easily transported thanks to standard wheel base



The dust extractor ha 2000.

Someone who is used to working cleanly and precisely, expects this also from the machines and tools in his workshop. With the dust extractors from scheppach, this is easy. All dust and chip producing machines (like planers, for instance) can be connected without any problems.

Thanks to the standard wheel base, the ha 2000 can be effortlessly moved to any place in the workshop, the compact design facilitates the movement.

With an air capacity of 800 m³/h, the ha 2000 filters any dirt in the workshop. A filter cartridge offered as an optional extra still increases the suction capacity. This filter cartridge retains even the finest particles. Your health will be grateful.

schepach

vacuums

ha 2600

Cleaning the air at the same time – the dust extractor ha 2600.

The ha 2600 from schepach thoroughly cleans the working surfaces of your machines from chips. In addition, it filters the dust particles at 1000 m³ per hour.

A low noise, solid fan blows chips and dirt into the cyclone part where coarse particles are separated into the plastic bag. The pre-cleaned air passes through the filter system, and the cleaned air is blown back into the workshop. This air return is economical saving on heating costs.

More filter, more capacity, more air. You can increase the suction performance of your ha 2600 by attaching

The surface of the optional filter cartridge retains even the smallest dust particles.



ha 2600 shown with optional filter cartridge.

Top Features

✓1000 m³/h air capacity

✓Low noise level

✓Easily transported thanks to huge standard wheel base

the special filter cartridge offered as optional extra. This cartridge is easy to clean, removes even the finest dust particles from the air and, due to its large filter surface, has a high air throughput. Like the ha 3210, the ha 2600 is qualified for professional use.



ha 3210

New!



Top Features

- ✓ 2000 m³/h air capacity
- ✓ Low noise level
- ✓ Easily transported thanks to huge standard wheel base

More than a touch of professionalism – the dust extractor unit ha 3210.

All the latest technology is incorporated in the design, performance, safety regulations, and filter techniques of the ha 3210. The ha 3210 has been designed for connection to powerful woodworking machines in your private workshop, and has the corresponding capacity. 2000 m³ of air are thoroughly cleaned and returned to the working area. The important hose diameter of 140 mm is suitable for big machines and can be adapted to scheppach machines by a reduction piece. A filter cartridge of a filter surface of 9.5 m² (optional extra) can still increase the capacity.

With the ha 3210 you get low power consumption, low noise, and a small volume due to the compact construction. Two large wheels and two steering rollers make the ha 3210 fast and manoeuvrable.

schepach

vacuums

ha 2000

ha 2600

ha 3210



New!

ha 2000



ha 2600



New!

ha 3210

Standard equipment	Safe and sturdy wheel base, filter bag, BIA tested, waste bag, hose, connection piece, earthing set		Safe and sturdy wheel base, filter bag 13, BIA tested, waste bag, hose, connection piece, earthing set		Safe and sturdy wheel base, filter bag 14, BIA tested, waste bag, hose, connection piece, earthing set	
Test certificate	CE		CE		CE	
Technical data Dimensions l/w/h mm Air capacity m ³ /h, l/sec Filter surface m ² Filling capacity l Hose length mm Hose ø mm Gewicht ca. kg	650/500/1,640 800 1 80 2,000 100 25		640/490/1,880 1,000 1 80 2,500 100 30		1,030/580/1,860 2,000 1.65 130 2,500 140 40	
Motor Input kW (PS) Output kW (PS)	220-240 V/50 Hz 0.4/0.55 0.3/0.41		220-240 V/ 50 Hz 0.6/0.8 0.37/0.5	400 V/50 Hz 0.55/0.75 0.37/0.5	220-240 V/ 50 Hz 1.04/1.4 0.75/1.0	400 V/50 Hz 2.2/3.0 1.5/2.0
Order No.	7508 0901		7503 0000	7504 0000	7521 0901	7521 0902

ha 2000

ha 2600

ha 3210

Accessories



for ha 2000,
ha 2600

Filter cartridge

for cat. U/S/G, BIA tested,
ø 330 mm, height 860 mm,
Filter surface 5 m² complete
with closing band
Order No. **7500 6000**

Waste bags 1,000 x 580 mm
transparent, bundle of 20
Order No. **7500 1500**

Suction hose

2.5 m, ø 100 mm, anti-static,
used as an extension
Order No. **7500 1023**

Hose extension coupling

ø 100 mm,
includes 2 hose clamps
Order No. **7500 3300**

Extension

ø 100 mm
Order No. **7520 8000**

Floor cleaning set

Floor suction nozzle 450 mm,
suction tube 105 x 900 mm,
Order No. **7520 5300**

Flat cleaning nozzle

for floor and machine cleaning
ø 100 x 134/30 x 300 mm
Order No: **7520 6003**

Filter bag

Cat. U/S, BIA tested
Order no. **7500 1019**

for ha 3200, Woova 5

Filter cartridge

Filter surface 9.5 m² for
cat. U/S/G, BIA tested, ø 330
mm, height 850 mm,
Order No. **7520 6203**

Filter bag

Cat.C, BIA tested, for carcino-
genic dust separation
Order No. **7520 6202**

Filter bag

Cat. U/S, BIA tested
Order no. **7520 0055**

Waste bags

1,000 x 850 mm
transparent, bundle of 20
Order No. **7520 6100**

Suction hose

2.5 M, ø 140 mm, antistatic
Order No. **7520 0010**

Hose connection piece

ø 140 mm
Order No. **7520 7000**

Reducing adaptor

from ø 140 to 100 mm,
Order No. **7520 6001**

Twin nozzle adapte

with shut off plate
ø 160/140/2 x
100 mm
Order No. **7524 0703**



Suction control

160 mm
Order No. **7520 6005**

for ha 2600, ha 3200

Automatic switch-on mechanism

2 versions available:

Version A

Working machine: single phase
Dust extractor: single phase
Mains supply: single phase
Order No. **7910 4010**

Version B

Working machine: single or
three phase current
Dust extractor: single or three
phase current
Mains supply: three phase
current
Order No. **7910 4020**



scheppach

mortises

hcm 25

Traditional hollow chisel mortising with the scheppach hcm 25.

World wide demand for a scheppach chisel mortiser has led to the introduction of the new hcm 25. The main headstock, table and vertical column are solid cast iron resulting in a stable, vibration free mortise machine. Precision machined castings operating on a dovetail slide principle ensure smooth, controlled movement. Complete with a steel cabinet floor stand with storage facility, the hcm 25 mortiser offers unbeatable value for money without a compromise on quality.

Adjustable guides ensure that any possible movement from years of constant use can be taken up so that the machine always remains as accurate as the day it is purchased. Powered by a 1 HP quiet running induction motor, the machine is capable of mortising up to 25 mm (1 inch) in soft woods and 20 mm (3/4 inch) in hard wood. 200 mm (8 inch) capacity is possible under the chisel. A steel cabinet floor stand which serves as a storage cabinet for tooling comes as standard.



Top Features

- ✓ Solid cast iron construction
- ✓ Precision machined castings
- ✓ Fully adjustable guides
- ✓ 1 hp induction motor
- ✓ 25 mm softwood & 20 mm hardwood mortising capacity
- ✓ 200 mm capacity under the chisel

The new hcm 25 – traditional hollow chisel mortising from scheppach.

schepach

mortises

hcm 25



Statement in Practical Woodworking

The hcm 25 has a lot going for it, including the wooden facing on the table, the effective length and depth stops, and the hold-down clamps which come into their own when working on larger timbers and deeper mortises. The way the handle can be readily adjusted is another plus. Overall, a well designed and solidly constructed machine, built to last.

RATING ★★★★★

Tested by Gordon Warr

Standard equipment

Stable cast iron construction, exakt swallow-tailed guidance, toothed rack adjustment, big handwheels for table adjustment, base with lockable door

Technical data

l/b/h 635/400/1010 mm
 Table size 400 x 150 mm
 Table height with base 850 mm
 Table adjustment
 270 x 150 mm
 Drill stroke 220 mm
 Distance drill – fence 150 mm
 Drill depth max. 70 mm
 Drill size max. 25 mm
 Workpiece height max. 200 mm
 Table adjustment X 180 mm
 Table adjustment Y 150 mm
 Handwheel Ø 120 mm
 Table height 240 mm
 Weight approx. 91 kg

Motor 230 V / 50 Hz
 Input Watt 750

Order No. **8800 1920**



Mortise depth settings done through quick adjustment of easy lock levers.



Door lock and hinge mortise holes are done by simply reversing the headstock position.



Picture fitted with versatile quick release hold-down clamps and table traverse handwheels as standard.

Panel saws

The panel saws Forsa 5 and Forsa 7 you can rely on: they assure you absolutely precise cuts in every dimension, which is guaranteed by different constructive details:

- **absolutely plane** gray cast-iron table top
- **66 m/s cutting speed**
- **2,100/2,600 mm panel sliding table**
- **107 mm cutting height**
- **patented Duplex system:** height and angle adjustment by hand wheel

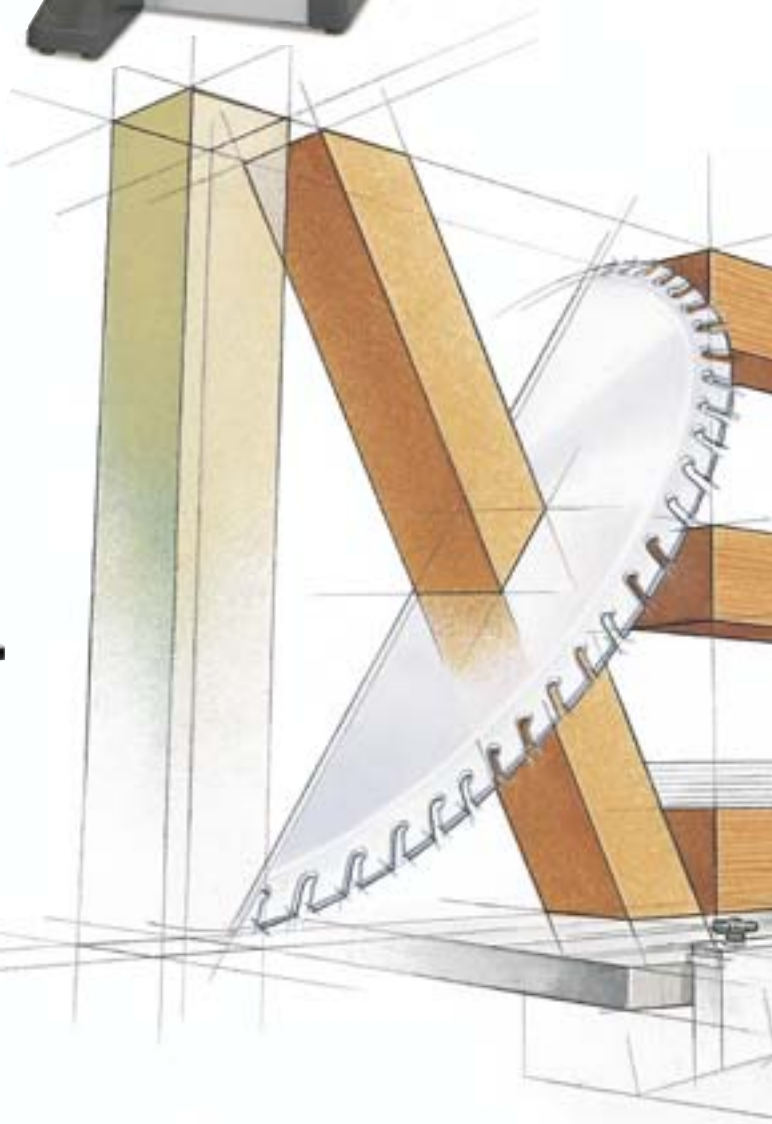

Spindle moulder machines

The Molda 7 and the Molda 7f spindle moulders serve your creativity. The great number of setting varieties already included in the basic equipment allow almost any moulding task. With their large-size and variable supporting surfaces, you can also handle large work pieces effortlessly and precisely. This is guaranteed by the following constructive details:

- **absolutely plane gray cast-iron table top**
- **Height and side-adjustable moulding spindle running clockwise or anti-clockwise**
- **patented Duplex system:** height and diagonal adjustment by hand wheel
- **100 mm maximum height adjustment**
- **3,000/6,000/8,200 rpm spindle speeds**





Planing machines

Irrespective of its size and power, the Plana 7 offers finesse in both design detail and finished output performance. The final planing result will save considerable finishing time; guaranteed by the following manufacturing details to all the requirements. That saves you time and increases the range of your woodworking activities, that is guaranteed by the following constructive details:

- electric feed at two speeds
- rubber-lined feed rollers protecting your wood from indentation marks
- folding surfacing tables made of cast-iron
- 410 mm surface planing width
- 400 mm thickening passage
- 230 mm thickening height
- adjustable and pivoting surfacing fence

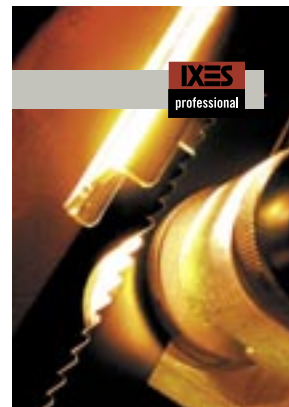

Order your free catalogue



Dust extractor units

If woodworking is your passion, you cannot do without a powerful dust extractor. The models Woova 5 and Woova 7 excel by their high suction capacity and great chip volume. The IXES dust extractor units can be used in a flexible manner, guaranteed by the following manufacturing details:

- 770/3,000 m³/h air capacity
- standard wheel base
- 2.2 / 3.45 m² filter surface
- large chip bag, to be emptied at long intervals
- The Woova 7 has been tested for dust acc. to BG H2, and is therefore authorized for use at schools and in the professional sector.



Band saws

The IXES band saws are without competition in their class due to their important passage height and width, and they allow the superior treatment of large work pieces guaranteed by the following manufacturing details:

- band wheel made of cast iron with machined rubber lining
- continuously swinging gray cast-iron table
- 3-roller saw band guiding above and below the table
- table length extension standard, also to be used as table width extension
- 300/400 mm passage height
- 440/590 mm passage width



The new and innovative brand for the professional woodworker



scheppach

Garden and farm

Log saws with direct drive

- 500/700 mm saw blade
- 230 – 380 mm cutting capacity
- standard wheel base
- very good price/performance ratio due to direct drive
- welded construction, assembled ready for use



Rocker saws

- ø 500/600 mm saw blade
- 180/200 mm cutting capacity overall cut, 330/370 mm reversing cut
- drive by 2 V-belts offering 30 % more cutting capacity than conventional saws
- standard: TCT saw blade and wheel base
- welded construction, assembled ready for use



Rocker log saws

- cutting capacity: 270 mm overall cut, 540 mm reversing cut
- effortless working due to ideal rocker reversing point
- solid welded base, assembled ready for use
- available either with powerful three-phase motor or with pto drive



Rocker table saws

- 240 mm cutting height above table
- rocker cutting capacity: 250 mm overall cut, 500 mm reversing cut
- 2 cutting speeds for length and cross cuts
- effortless working due to ideal rocker reversing point
- solid welded base, assembled ready for use
- available either with powerful three-phase motor or with pto drive





Shredders

- silent shredder and quick runners in every class
- branch thickness up to 45 mm



Hydraulic splitters

- splitting performance from 5 to 12 tons
- to be used for short wood (52 cm) or long wood (105 cm)
- standard with 2-hand safety guiding
- choice between electric drive, pto drive or combination drive

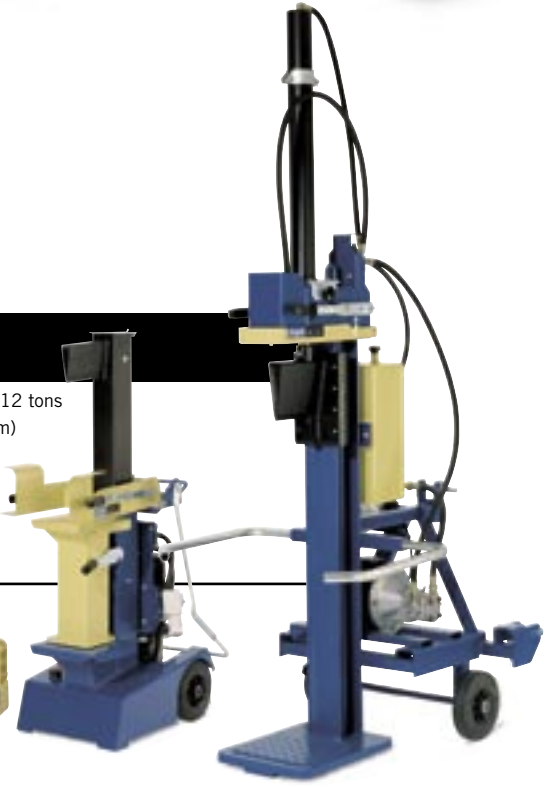
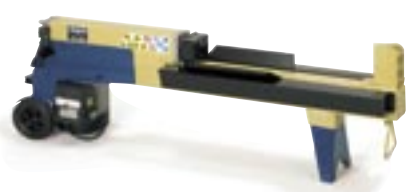

Roller sieve

- convenient filling height, 400 mm drum ø
- wheel barrow easily fits underneath sieve drum
- sieves and separates in one go
- for sieving compost, for adding to clustered gardening soil

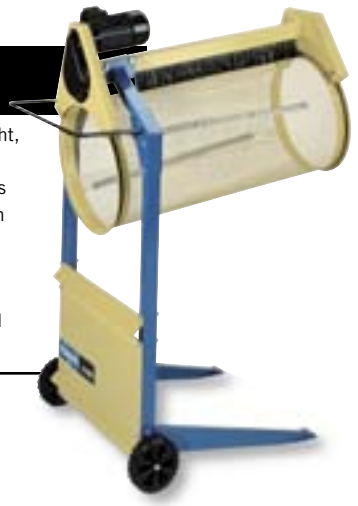

Roller table circular saw benches

- 700 mm ø saw blade
- 250 mm cutting height above table
- 2 speeds for length and cross cuts
- solid welded base, assembled ready for use
- available either with powerful three-phase motor or with pto drive

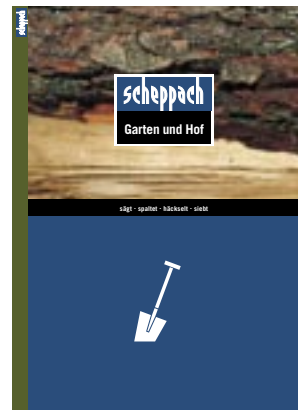

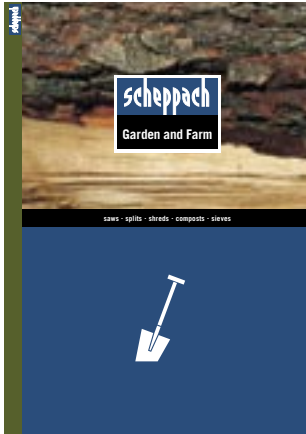

**You need something sturdy for your work in garden or yard?
Or you work as a woodworking professional?**

Then you should have a look at these catalogs:
"Garden and Farm" offers everything that facilitates your woodworking
Order no. 9322 0167

And with the new innovative marque IXES, scheppach offers the necessary equipment to the professional woodworker
Order no. 9322 0240

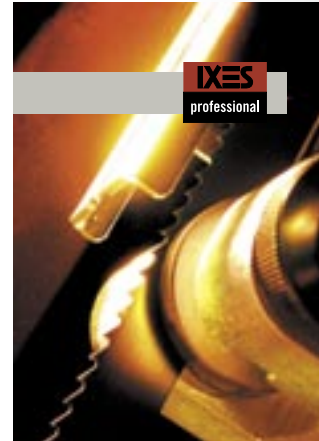

**Scheppach Fabrikation von
Holzbearbeitungsmaschinen GmbH**
D-89335 Ichenhausen
Telefon 00 49-82 23/40 02-0
Fax 00 49-82 23/40 02-20
e-mail: info@scheppach.com
Internet: <http://www.scheppach.com>

Service team:
Phone 0 82 23/40 02-99
Fax 0 82 23/40 02-92

Your scheppach specialist: