



SINCE 1946

GRIGGIO

Manufacturing by tradition

ita/fra/esp

Mod	Macchine Tradizionali / Machines Traditionelles / Máquinas Tradicionales	p
FS 530	FILO SPESSORE / DEGAUGHISSEUSE-RABOTEUSE / CAPILLADORA-REGRUESADORA	16
FS 410	FILO SPESSORE / DEGAUGHISSEUSE-RABOTEUSE / CAPILLADORA-REGRUESADORA	17
PSA 530	PIALLE A SPESSORE / RABOTEUSES / REGRUESADORAS	18
PSA 630R - PSA 630	PIALLE A SPESSORE / RABOTEUSES / REGRUESADORAS	19
PF 430 - PF 530R - PF 530	PIALLE A FILO / DEGAUGHISSEUSES / CEPILADORAS	20
TS 150 - TS 200 - TS 300	TENOSQUADRATRICI / TENNONNEUSES EQUADRISSEUSES / SIERRA-TUPIS ESCUADRADORAS	22
SC 32 - SC 1400	SQUADRATRICI / SCIES A FORMAT / ESCUADRADORAS	24
CA 40	SQUADRATRICI / SCIES A FORMAT / ESCUADRADORAS	26
UNICA 350	SQUADRATRICI / SCIES A FORMAT / ESCUADRADORAS	30
UNICA 400	SQUADRATRICI / SCIES A FORMAT / ESCUADRADORAS	36
UNICA 500	SQUADRATRICI / SCIES A FORMAT / ESCUADRADORAS	46
T210	TOUPIE / TOUPIE / TUPIS	56
T220 - T270	TOUPIE / TOUPIE / TUPIS	58
T220 - T270 HSK 63 E	TOUPIE / TOUPIE / TUPIS HSK 63 E	62
T 45 I	TOUPIE INCLINABILI / TOUPIE INCLINABLE / TUPIS INCLINABLE	68
T 45	TOUPIE INCLINABILI / TOUPIE INCLINABLE / TUPIS INCLINABLE	72
T 45 HSK 63 E	TOUPIE INCLINABILI / TOUPIE INCLINABLE / TUPIS INCLINABLE HSK 63 E	74
SNA - SNAC	SEGHE A NASTRO / SCIES A RUBAN / SIERRAS DE CINTA	78
SNAC 740RS3-940RS3-940RS3 SPECIAL	SEGHE A NASTRO / SCIES A RUBAN / SIERRAS DE CINTA	79
SW 640I - S 740/1500	SEGHE A NASTRO / SCIES A RUBAN / SIERRAS DE CINTA	80
PRISMA 740	SISTEMA PRISMATURA DOPPIA LAMA / SYSTEME A EQUAFFRIR A DELUX LAME / SISTEMA DE PRISMATURA DE DOUBLA HOJA	81
TRC/N - TRC/S	CAVATRICI / MORTAISEUSE / TALADROS DE BROCA	82
GF 21 - GF 23 - GF27 - GF35	FORATRICI / PERCEUSES / TALADROS	83
G65 5T - G63 3T	FORATRICI / PERCEUSES / TALADROS	84
G60 I - G80 I - G90 I	PANTOGRAFI / DEFONCEUSES / FRESADORAS	85
G800 - G900	PANTOGRAFI / DEFONCEUSES / FRESADORAS	86
GT 4S	TENONATRICE / TENONNEUSE / ESPIGADORA	87
GAT 180	TENONATRICE / TENONNEUSE / ESPIGADORA	88
GAT 150/4	TENONATRICE / TENONNEUSE / ESPIGADORA	89
GAL/E - GAL/P	CAVETTATRICE / MORTAISEUSES / RANURADORAS	90
G281 - G450 - G550S	CAVATRICI A CATENA / MORTAISEUSES A CHAINES / ESCOPLEADORAS DE CADENA	91
GL 25 - GL 30	LEVIGATRICI A NASTRO / PONCEUSES A BANDE / LIJADORAS DE BANDA	92
S220	SPAZZOLATRICE MANUALE / BRASSEUSE MANUELLE / LIJADORA MANUAL	93
GL 150 - GL 200	LEVIGATRICE OSCILLANTE / PONCEUSE OSCILLANTE / LIJADORA OSCILLANTE	94
GR 400-640-800-960-1250	SEGHE RADIALI / SCIES RADIALE / SIERRAS RADIAL	95
GSA	STRETTOIO / PRESSE / BANCO DE ARMAR	96
GS3	STRETTOIO / PRESSE / BANCO DE ARMAR	97
GA - GM - GV	AVANZAMENTI / ENTRAINEMENTS / ALIMENTADORES	98
GA 630 - GA 850	AFFILATRICI / AFFUTEUSES / AFILADORAS	99
GM 104S - GT 104S	AFFILATRICI / AFFUTEUSES / AFILADORAS	100
G5 30/4 - G 10/40 - G 20/60	SALDATRICE / SOUDEUSE / SALDADORA	100
GA U5 - GA 600	AFFILATRICI / AFFUTEUSES / AFILADORAS	101

Mod	Macchine Speciali / Machines Spéciales / Máquinas Especiales	p
G18 Q - G22 Q	PIALLATRICE / CORROYEUSE / CEPILLADORA	103
G230/4 - G230/5U	SCORNICIATRICI / CORROYEUSES / MOLDURERAS	104
G 240-4-5/5U-6/6U-7U	SCORNICIATRICI / CORROYEUSES / MOLDURERAS	106
C 300 / C 350	SEGA CIRCOLARE MULTILAME / SCIE CIRCULAIRE MULTILAME / SIERRA CIRCULAR MULTIPLE	108
G66 / 10T	FORATRICI / PERCEUSES / TALADROS	109
GC65 - GC95 - GC 110	LEVIGATRICE/CALIBRATRICE - PONCEUSE/CALIBREUSE - CALIBRADORA/LIJADORA	110
GI 1100 - GI 1300	LEVIGATRICE/CALIBRATRICE - PONCEUSE/CALIBREUSE - CALIBRADORA/LIJADORA	112
R 1300 - S 1300	SPAZZOLATRICE/RUSTICATRICE - BRASSEUSE EFFECT RUSTIQUES - LIJADORA	114
S 200/3 - S 200/4	SPAZZOLATRICI PROFILI/BROSSEUSES PROFILS/LIJADORA PERFILS	115
R 300 - 600 - 800	RUSTICATRICE/BROSSEUSES EFFECT RUSTIQUE/LIJADORAS PARA SACAR LA VETA	116
S 300 - 600 - 800	SPAZZOLATRICI/BROSSEUSES/LIJADORAS AUTOMATICAS	117
GP PRESSE	PRESSE / PRESSEES / PRENSAS	118
GRR 300-800-1300-1400-1600	INCOLLATRICI / ENCOLLEUSES / ENCOLLADORAS	120
GPM 300	PRESSA VACUUM/PRESSES/PRESNA VACUUM	121
GB 60/10	BORDATRICI / PLAQUESES / CHAPEADORAS	122
GR 91 - GRA	REFILATORE-ARROTONDATORE/ROGNEUR-ARRONDISSEUR/REFILADOR-REDONDEADOR	123
GB 2/3 - 3/3 - 4/3	BORDATRICI / PLAQUESES / CHAPEADORAS	124
GB 2/8 - GB 4/8 - GB 5/8 R - GB 5/15 - GB 5/15R	BORDATRICI / PLAQUESES / CHAPEADORAS	128
GSV 13-14 - GSV 32E-42E	SEZIONATRICI VERTICALI / SCIES A PANNEAUX VERTICALES / SECCIONADORAS VERTICALES	139
GS 32/70 - 38/70- 44/70 - 32/95 - 38/95 - 44/95	SEZIONATRICE ORIZZONTALE/SCIENS A RUBAN HORIZONTALES/SIERRA DE CINTA HORIZONTAL	140
GAT 35 - GAM 10/22/33	CENTRO ANGOLARE/CENTRE ANGULAIRE/CENTRO ANGULAR	142
CNC 353 - 353N	CENTRI DI LAVORO CNC / CENTRES DE TRAVAIL CNC / CENTROS DE TRABAJO CNC	144
CNC 750	FORATRICE ON A PANNELLO PASSANTE / PERCEUSE ON A PANNEAU PASSANT / CENTRO DE TRABAJO CN CON PANEL PASANTE	146
CNC 1000	FORATRICE ON A PANNELLO PASSANTE / PERCEUSE ON A PANNEAU PASSANT / CENTRO DE TRABAJO CN CON PANEL PASANTE	148
CNC 2100	CENTRI DI LAVORO CNC PORTE / CENTRES DE TRAVAIL CNC PORTES / CENTROS DE TRABAJO CNC PUERTAS	150



The Italian Concept

Since 1946

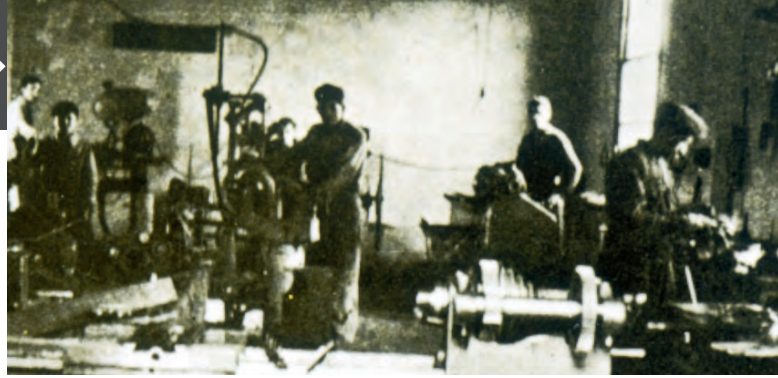

Un'azienda, una famiglia

Un'azienda, e prima ancora una famiglia. A partire da quel lontano 1946, anno della sua fondazione - ad opera di Guerrino e Giovanni Griggio a Cadoneghe, nell'industriosa e dinamica terra veneta - per risalire ad un tempo molto più remoto, ma che ancor oggi vive e fruttifica nei valori e nei principi di una filosofia aziendale che affonda le sue radici in una tradizione millenaria. Una tradizione, come quella veneziana della Serenissima, che, con Marco Polo, incarnò al meglio quello spirito innovatore, quella ricerca di nuovi orizzonti e quell'intraprendenza commerciale che la resero famosa nel mondo.

Une maison, une famille

Une maison, mais aussi une famille. Depuis 1946, année de sa fondation: créée par Guerrino et Giovanni Griggio à Cadoneghe, dans l'industrielle et dynamique Vénétie pour remonter aux temps les plus anciens, mais qui aujourd'hui encore, vit et prospère dans les valeurs et les principes d'une philosophie de l'entreprise qui plonge ses racines dans une tradition millénaire. Une tradition, comme celle de la Vénétie de la Serenissima, qui, avec Marco Polo, incarne au mieux cet esprit d'innovation, cette recherche de nouveaux horizons, cette audace commerciale qui la portèrent à être excellente dans le monde.

Una Empresa, una familia

Una empresa y antes una familia. Desde el lejano 1946, año de la fundación - obra de Guerrino y Giovanni Griggio en Cadoneghe, en la industrial y dinámica tierra Veneta - y aunque es grande el tiempo transcurrido todavía vive y fructifica en los valores y en los fundamentos de una filosofía de empresa que tiene la raíz en una tradición milenaria. Una tradición, como la de Venecia de la Serenissima, que, con Marco Polo, personificó lo mejor de aquel espíritu innovador, aquella exploración de nuevos horizontes y aquella iniciativa comercial que la han hecho famosa en el mundo.



Nel 1946 nasce l'azienda Griggio e produce i primi modelli di combinate universali.

En 1946, à ses débuts, naît à la maison Griggio les premiers modèles des combinees universelles

En el 1946 nace la empresa Griggio y produce los primeros modelos des combinadas universales

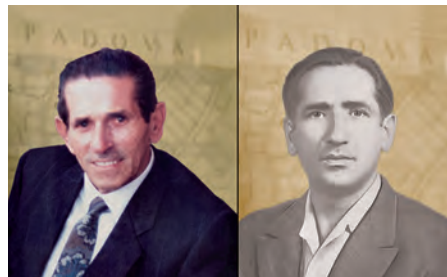

Griggio Guerrino

Griggio Giovanni



"La GRIGGIO Spa è un'azienda protagonista della storia del suo territorio."

"La GRIGGIO Spa est une maison protagoniste dans l'historique de son domaine."

"GRIGGIO Spa es una empresa protagonista de la historia de su territorio."

"Industriosa Cadoneghe" - Edizione 2001



Paolo Griggio

«Intraprendenza e lungimiranza, caratteristiche fondamentali alla base del processo di espansione»

«Audace et clairvoyance, caractéristiques fondamentales qui sont à la base du procès d'expansion»

«Iniciativa y perspicacia, características fundamental a la base del proceso de expansion»

Quello stesso spirito, quella stessa intraprendenza, quella stessa lungimiranza oggi caratterizzano la Griggio che dalla sua nascita fino ad oggi, sotto la guida dei figli dei fondatori, ha conosciuto un processo di continua espansione e innovazione tecnologica. Grazie ad una profonda conoscenza del mercato, grazie alla capacità di coglierne i fermenti anticipando i trend del futuro e, soprattutto, grazie ad un coraggio imprenditoriale che anima da sempre, caratterialmente, ogni singolo membro della famiglia.

Ce même esprit, cette même audace, cette même clairvoyance aujourd'hui caractérisent la maison Griggio qui, de son début à aujourd'hui, sous l'égide des fils des fondateurs, a connu un succès continu et d'innovation technologiques. Grâce à une connaissance profonde du marché, grâce aux capacités d'en recueillir les résultats en anticipant les éventuels imprévus du future, surtout, grâce au courage des chefs d'entreprise qui animent depuis toujours d'une façon viscérale, chaque membre de la famille.

Aquel mismo espíritu, aquella misma iniciativa, aquella misma clarividencia caracterizan a Griggio que desde su nacimiento hasta hoy, con la guía de los hijos de los fundadores, han desarrollado un proceso en continua expansión y innovación tecnológica. Gracias a un profundo conocimiento del mercado, gracias a una capacidad para captar ideas adelantando las novedades del futuro y, sobre todo, gracias a un coraje empresarial que anima desde siempre, caracterizado singularmente en cada miembro de la familia.



Ennio Griggio

«Salde radici per una sana e solida tradizione familiare, un'eredità importante»

«Racines solides pour une saine et ferme tradition familière, un héritage important»

«Solida raiz para una sana y fuerte tradicion de familia, una herencia importante»

Un'eredità importante fatta propria e rinnovata con passione e grande professionalità per trasformarla in un presente di successi, tutti raggiunti con la convinzione e la tenacia di chi ha saputo applicare i principi di una sana e solida tradizione familiare alla gestione di un'azienda che è oramai un punto di riferimento nel mercato internazionale.

Un héritage important qui a été acquis et renouvelé avec passion et grand professionnalisme pour la transformer dans un succès toujours présent, gagné avec la conviction et la ténacité de celui qui a réussi à appliquer ses principes d'une saine et solide tradition familiale, à la gestion d'une maison qui est désormais un point de référence sur le marché international.

Una herencia importante hecha propia y renovada con pasión y gran profesionalidad para transformarla en un presente de éxitos, todos llegados con la gran convicción y la tenacidad que han sabido aplicar a los principios de una sana y sólida tradición familiar en la gestión de una empresa que ahora es un punto de referencia en el mercado internacional.

Griggio Group



Reschigliano (PD) - Italy

Oltre alla sede centrale situata a Reschigliano, in provincia di Padova, che vanta 15.000 mq di strutture produttive, l'azienda presenta altre due unità: una a Novellara (Reggio Emilia) e l'altra a Codiverno (Padova). L'internazionalità della Griggio, inoltre, è garantita da una filiale in Russia, a Mosca, e da numerose altre partnership con realtà commerciali in tutto il mondo.

En plus de son siège situé à Reschigliano, dans la province de Padoue, qui s'enorgueillit de posséder 15.000 mètres carrés de structure productives, la maison présente deux autres unités: une à Novellara (Réggio Emilia) et l'autre à Codiverno (Padoue). L'internationalité de la maison Griggio est en outre assurée par une filiale en Russie: à Moscou, et par de nombreux autres partenaires aux réelles qualités commerciales dans le monde entier.

Más apartados de la sede central de Reschigliano, en la provincia de Padova, con 15.000 metros cuadrados de estructura productiva, la empresa tiene otras 2 instalaciones: una en Novellara (Reggio Emilia) y la otra en Codiverno (Padova). La internacionalidad de Griggio, además esta complementada por una filial en Rusia, en Moscú, y de muchos otros distribuidores con presencia comercial en todo el mundo.



Griggio Centre Moscow - CSI Since 2006

Представительство Акционерного общества
«ГРИДЖО С.П.А.»
Ул. Флотская, 5 корп. Б, оф 109,
125493, Москва, Россия
Tel. +7-495-544-54-20, fax +7-495-544-54-21
e-mail: info@griggio.ru
www.griggio.ru





Since 1983

Novellara (RE) - Italy



Since 1984

Campodarsego (PD) - Italy



Dall'idea al progetto, **tutto in azienda**

Tutte le macchine Griggio sono progettate dall'Ufficio Tecnico interno alla ditta. Vera e propria fucina di idee, l'ufficio progettazione è il cuore pulsante di un'azienda che sa soddisfare al meglio le richieste dei propri clienti perché sa monitorare con sguardo attento e grande perspicacia il mercato. Un'operazione indispensabile per ottenere quelle informazioni che un team di professionisti altamente qualificato quotidianamente rielabora nel modo migliore per la realizzazione di un prodotto finale all'avanguardia.



Giovanni Griggio

«Professionalità-idee-tecnologia innescano un meccanismo per ottenere un prodotto finale all'avanguardia»

«Professionnalisme-idée-technologie déclenchent un mécanisme pour obtenir un produit final à l'avant garde»

«Profesionalidad-ideas-tecnología son un mecanismo para obtener un producto final a la vanguardia»

De l'idée au projet, **tout dans une maison**

Toutes les machines Griggio sont projetées dans le bureau technique intérieur à la maison. Véritable forge d'idées, le bureau de projet est le cœur battant d'une maison qui sait satisfaire au mieux les demandes de ses clients car elle sait tester le marché par un regard attentif et une grande perspicacité. Une opération nécessaire pour obtenir ces renseignements qu'une équipe de professionnels très qualifiés élabore chaque jour de la meilleure façon, la réalisation d'un produit final qui est à d'avant garde.

Desde la idea hasta el proyecto, **todos en la empresa**

Todas las máquinas Griggio están proyectadas en la Oficina Técnica interior de la empresa. Verdadera ori-gen de ideas, la oficina de proyectos es el corazón que impulsa a la empresa para poder satisfacer en lo mejor las peticiones de los clientes porque tiene una atención y percepción del mercado. Una operación indispensable para tener aquellas informaciones que un equipo de profesionales muy cualificado todos los días estudia la manera de mejorar la realización de un producto final de vanguardia.

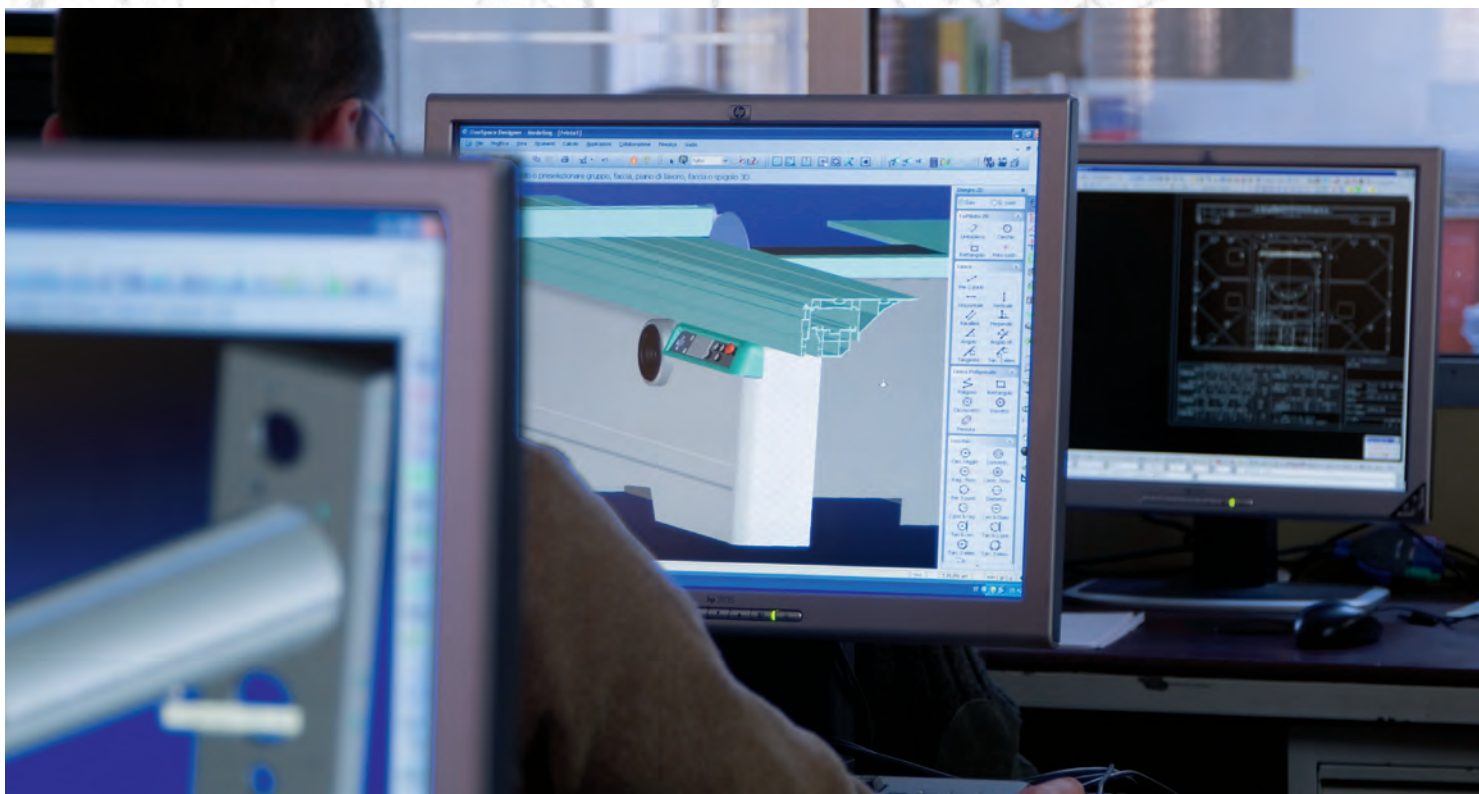



Grazie alle nuove idee, il mercato Griggio diventa competitivo

Grâce aux nouvelles idées, Griggio devient compétitif sur le marché

Gracias a las nuevas ideas, el mercado Griggio es competitivo

Ogni macchina Griggio è il risultato di un percorso che dalla progettazione porta alla realizzazione dei prototipi che, dopo numerose verifiche e test di controllo, in partnership con istituti universitari specializzati, conducono alla produzione e commercializzazione di macchine capaci di soddisfare i più alti standard qualitativi.

Chaque machine Griggio est le résultat d'un parcours qui du projet à la réalisation des prototypes, après de nombreuses vérifications et de tests de contrôle, en partenariat avec des institutions universitaires spécialisées, aboutissent à la production et à la commercialisation de machines en mesure de satisfaire les standards qualitatifs les plus élevés.

Cada máquina Griggio es el resultado de un recorrido que va desde el proyecto hasta la realización de los prototipos, después de muchas verificaciones y pruebas de control, en colaboración con institutos y universidades especializadas, se llevan a la producción y comercialización de máquinas capaces de satisfacer los mas elevados estandards de calidad.

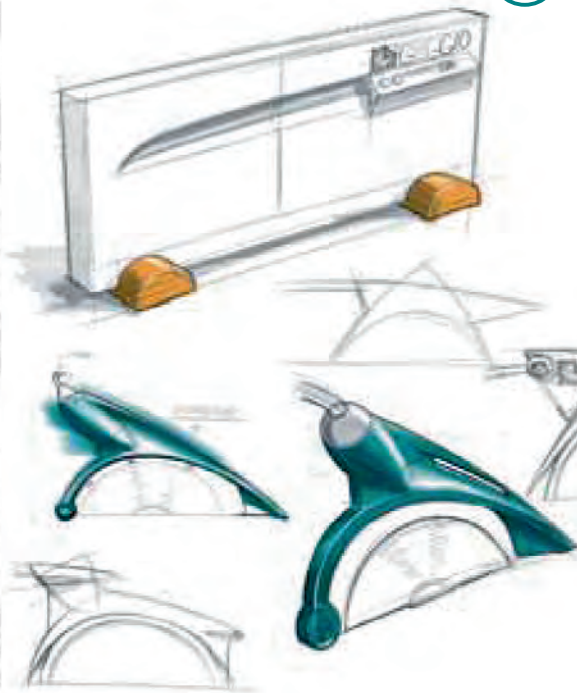

Qualità & Tecnologia



Obiettivo numero Uno: Qualità totale

Mantenere elevati standard di qualità sia nel prodotto finale che nel processo di produzione, questo è l'obiettivo numero uno della Griggio.

Forte della Certificazione ISO 9001-Vision 2000, la qualità dei prodotti Griggio viene garantita da costanti e rigorosi controlli durante l'intero processo produttivo. Ad occuparsene l'Ufficio Qualità interno all'azienda, creato per gestire il delicato aspetto della supervisione e del rispetto degli standard qualitativi dalla progettazione alla realizzazione fino alla commercializzazione del prodotto finale.

Un incontro di idee e tecnologia, di intuizione ed alta professionalità che innescano un meccanismo creativo che raggiunge il punto più alto ad ogni macchina Griggio.

Une rencontre de idées et de technologie, d'intuitions et de haut professionnalisme, déclenchant un mécanisme créatif pour permettre de rejoindre le point le plus haut pour chaque machine Griggio.

Un conjunto de ideas y tecnologías, de percepción y elevada profesionalidad que inicia un mecanismo creativo que llega al punto mas alto en cada máquina Griggio.

Premier objectif: Qualité totale

Maintenir des standards de qualité élevés dans le produit final, comme dans le processus de production, est le premier objectif de la Griggio Spa.

Fort de la certification ISO 9001-Vision 2000, la qualité des produits Griggio est garantie par de constants et de rigoureux contrôles durant la totalité du processus de production.

Le Bureau Qualité interne à la maison a été créé pour gérer le délicat travail de la supervision et du respect des standards qualitatifs, du projection à la réalisation jusqu'à la commercialisation du produit final.



Ogni progetto viene sottoposto ad intense prove

Chaque projet est soumis à des essais multiples et intenses

Cada proyecto es sometido a difíciles pruebas

Objetivo numero Uno: Calidad Total

Conservar elevados estandards de calidad en el producto final y en el proceso de producción, esto es el objetivo número uno de Griggio.

Fruto de la Certificación ISO 9001-Visión 2000, la calidad de los productos Griggio está garantizada por constantes y minuciosos controles durante todo el proceso productivo. La que se ocupa es la Oficina de Calidad que está en el interior de la empresa, creada para gestionar el delicado aspecto de la supervisión y del respeto de los estandards de calidad desde el proyecto y la realización hasta la comercialización del producto final.

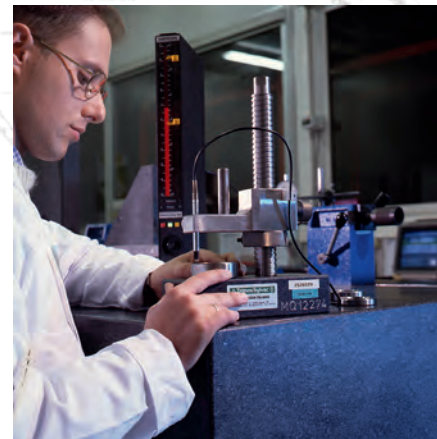

AZIENDA CON SISTEMA DI GESTIONE
PER LA QUALITÀ CERTIFICATO DA DNV
= UNI EN ISO 9001:2000 =





Impegnato in un minuzioso lavoro di raccolta dati, l'Ufficio Qualità ha creato nel tempo un archivio di informazioni in continuo aggiornamento, indispensabile per sviluppare nuove ed efficaci migliorie in tutte le macchine e garantire la qualità totale e l'eccellenza del prodotto al suo ingresso nel mercato. Tutte le macchine prodotte alla Griggio vengono sempre realizzate con materiali e prodotti certificati e di qualità.

Chargé d'un travail minutieux dans la récolte des données, le bureau qualité a créé au fil du temps des archives de renseignements constamment mis à jour : travail essentiel pour développer des améliorations nouvelles et efficaces sur toutes les machines et ainsi garantir une qualité totale et une excellence du produit dès son entrée sur le marché. Toutes les machines construites à la maison Griggio sont toujours fabriquées avec des matériaux, des matériaux et des produits certifiés de qualité.

Empeñado en un escrupuloso trabajo de selección de datos, la oficina de Calidad tiene un archivo de información en continua actualización, indispensable para desarrollar nuevas y eficaces mejoras en todas las máquinas y garantizar la calidad total y la excelencia del producto en el mercado. Todas las máquinas producidas en Griggio son siempre realizadas con materiales y productos certificados y de calidad.



Processo produttivo di tutti i componenti con utilizzo di tecnologia all'avanguardia

Process productifs d'utilisation des composants, de technologie à l'avant garde

Proceso productivo de todos los componentes con la utilización de tecnologías en vanguardia



Aperti all'innovazione

Tradizionale nei valori fondanti l'azienda e all'avanguardia nell'applicazione dell'alta tecnologia ai suoi prodotti, la Griggio si propone nello scenario internazionale come una realtà con solide radici nel passato, ma proiettata verso il futuro.

Attenta ai mutamenti del mercato e al rapido evolversi della scienza tecnologica per soddisfarne tutte le esigenze, l'azienda si è da sempre rivelata particolarmente sensibile a sperimentare gli innumerevoli vantaggi che soluzioni innovative potevano offrire allo sviluppo e al potenziamento della propria produzione.

Un'apertura totale, quella della Griggio, alla tecnologia intelligente, alle evoluzioni di una tecnica che abbia come obiettivo il miglioramento delle prestazioni dei prodotti, alla innovazione tecnologica che porta a perfezione la risposta dell'azienda alle richieste di una clientela sempre più esigente e al passo con i tempi.



Massimo Griggio

«Apertura alla tecnologia intelligente come obiettivo per il miglioramento delle prestazioni del prodotto»

«Ouverture à la technologie intelligente comme objectif pour l'amélioration des prestations du produit»

«Abertura a la tecnologia inteligente como objetivo para mejorar las prestaciones del producto»

Ouvert à l'innovation

Traditionnelle dans ses valeurs fondamentales, la maison est aussi à l'avant garde dans l'application des technologies supérieures pour ses produits, la Griggio se situe sur la scène internationale comme une réalité avec ses solides racines du passé, mais projetée vers le future.

Attentive aux changements du marché et au rapide développement de la science technologique pour satisfaire à toutes les exigences, la maison s'est toujours montrée particulièrement sensible à essayer les nombreux avantages que des solutions innovatrices pouvaient offrir au développement et au renforcement de sa production.

Une ouverture totale, celle de la maison Griggio, à la technologie intelligente, aux évolutions d'une technique qui a comme objectif le progrès des prestations, pour des produits à l'innovation technologique pour porter à la perfection les réponses de la maison aux demandes d'une clientèle toujours plus exigeante et au rythme du temps actuel.

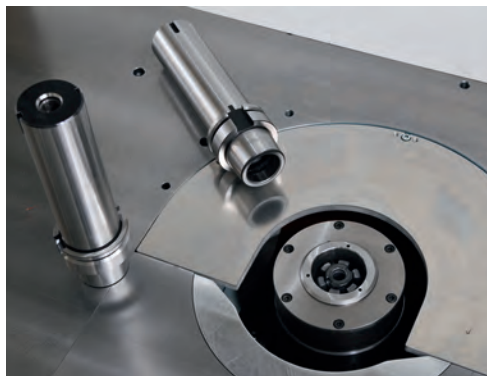

HSK 63 E

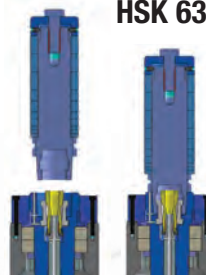

Abiertos a la innovación

Tradicional en los valores que fundamentan la empresa y a la vanguardia en la aplicación de la elevada tecnología de los productos, la empresa Griggio se posiciona en el mercado internacional como una realidad con sólida raíz en el pasado pero atenta al futuro.

Pendientes a los cambios del mercado y al rápido mutar de la ciencia tecnológica para satisfacer todas las exigencias, la empresa está siempre dispuesta a experimentar las grandes ventajas que soluciones innovadoras puedan ofrecer al crecimiento y al potenciamiento de la producción.

Una apertura total, de Griggio, a la tecnología inteligente, a la evolución de una técnica como objetivo que lleva a la perfección en respuesta de la empresa a las peticiones de los clientes siempre mas exigente y modernos.



“G OK”

Un simbolo, una garanzia

Un simbolo dalla grafica sorridente per esprimere positività, fiducia, affidabilità. Il marchio “G OK” è stato ideato per evidenziare e rendere immediatamente riconoscibili e distinguibili nel mercato le caratteristiche che rendono i prodotti Griggio più rapidi nella messa a punto ed efficienti nel loro utilizzo. La G di Griggio, dunque, come sinonimo di qualità, ergonomia, innovazione e vantaggi assicurati.

Un symbole, une garantie

Un symbole au graphique souriant pour exprimer: positivité, confiance, fiabilité. La marque « G OK » a été conçue pour mettre en évidence et rendre immédiatement reconnaissables les produits Griggio sur le marché, pour leur mise au point et leur efficacité dans leur emploi. La G de Griggio, donc, comme synonyme de qualité, ergonomie, innovation et avantages assurés.

Un simbolo, una garantía

El simbolo de la ilustración con la sonrisa para expresar eficacia, confianza, fiabilidad. La marca “G OK” ha sido pensada para evidenciar y hacer inmediatamente reconocible y visible en el mercado las características que hacen los productos Griggio mas rápidos en puesta en marcha y eficaces en el uso. La G de Griggio, como sinónimo de calidad, ergonomía, innovación y ventajas aseguradas.





Massimo Carraro - Service Manager

Direct phone
Mobile
e-mail

+39 049 9299746

+39 335 1325409

massimoc@griggio.com

Un servizio che conta e su cui contare

L'efficienza è un punto fermo della Griggio. Garantita durante l'intero processo che parte dalla progettazione e arriva fino all'assistenza, permette di offrire al cliente, in ogni singola fase, la certezza di un servizio professionale e puntuale. E, soprattutto, di un servizio su cui poter sempre contare.

La messa a funzione di questo meccanismo perfetto è uno dei punti di forza dell'azienda ed è stato possibile crearlo grazie ad un efficiente sistema di programmazione, studiato e perfezionato negli anni, che permette di consegnare i prodotti ai clienti sempre nei tempi prefissati.

Un service qui compte et sur lequel compter

L'efficacité est un point fixe de la maison Griggio. Garantir un processus total du départ du projet jusqu'à l'assistance, permettant d'offrir au client, à chaque étape, la certitude d'un service professionnel et ponctuel. Et, surtout d'un service sur lequel pouvoir toujours compter.

La mise en service de ce mécanisme parfait est un des points de force de la maison: il a été possible de l'obtenir grâce à un système efficace de programmation étudié et perfectionné au cours des années pour permettre de distribuer les produits aux clients dans les délais fixés.

Un servicio que cuenta en el que se puede contar

La eficacia es el punto mas importante de Griggio. Garantizada durante todo el proceso que empieza desde el proyecto y termina con la asistencia, permite de ofrecer al cliente, en cada singular fase, la certeza de un servicio profesional y puntual. Y, en particular, de un servicio en que se puede contar siempre.

La puesta en marcha de este mecanismo perfecto es uno de los puntos de fuerza de la empresa y ha sido posible realizarlo gracias a un sistema eficaz de programación, estudiado y perfeccionado en los años, que permite entregar los productos a los clientes en el plazo pactado.



Ricambi: un servizio su cui contare

Pièces détachées: un service sur lequel compter

Repuestos: un servicio el que se puede contar



Un trasporto veloce

Transport rapide

Transporte rápido



Il prodotto arriva puntuale

Un produit livré d'une façon ponctuelle

El producto llega puntual

Un sistema estremamente affidabile, costantemente aggiornato ed in continua evoluzione per garantire risultati sempre migliori.

Un système extrêmement fiable, constamment mis au jour et en continuelle évolution pour garantir des résultats toujours meilleurs.

Un sistema muy cuidado, constantemente puesto al día y en continua evolución para garantizar resultados siempre mejores.



Griggio On-Line, in tempo reale

On line per un servizio completo e immediatamente accessibile. Il sito della Griggio è una porta sempre aperta che permette al cliente di entrare in contatto diretto con l'azienda in tempo reale. Un servizio che garantisce interattività, risposte veloci, gestione offerte e un facile accesso alle informazioni sull'ampia gamma di macchine proposte dall'azienda.

In continuo aggiornamento e potenziamento per offrire sempre maggiori opportunità a chi si collega on line, il sito della Griggio si pone come ulteriore strumento offerto al cliente per trovare la risposta giusta, e in tempi rapidi, ad ogni sua richiesta.

Griggio On-Line, en temps réel

Sur Internet pour un service complet et immédiatement accessible.

Le site de la maison Griggio est une porte toujours ouverte qui permet au client d'entrer en contact direct avec la maison en temps réel. Un service qui garantit l'interactivité, réponses rapides, gestion des offres et un accès facile aux informations sur une vaste gamme de machines proposées par la maison.

La maison a une mise à jour ininterrompue et une grande potentialité pour toujours offrir d'importantes opportunités à qui se branche « on line ». Le site Griggio est un véritable instrument permettant d'offrir au client une réponse exacte et rapides à chaque demande.

Griggio on line, en tiempo real

On line para un servicio completo e inmediatamente accesible. El sitio de Griggio es una puerta siempre abierta que permite al cliente entrar en contacto directo con la empresa en tiempo real. Un servicio que garantiza interactividad, contestaciones rápidas, cotización de las ofertas y un fácil acceso a las informaciones de la gama de máquinas propuestas por la empresa.

En continua puesta al día para ofrecer siempre la mejor oportunidad a quien se conecta on line, el sitio de Griggio se pone como un instrumento adicional ofrecido al cliente para buscar la respuesta correcta, y en tiempo rápido, a cada solicitud de información.



Facile accesso alle informazioni

Accès facile aux informations

Fácil acceso a las informaciones

Griggio On-Line
è un servizio in tempo reale

Griggio On-Line
est un service en temps réel

Griggio On-Line
es un servicio en tiempo real

www.griggio.com

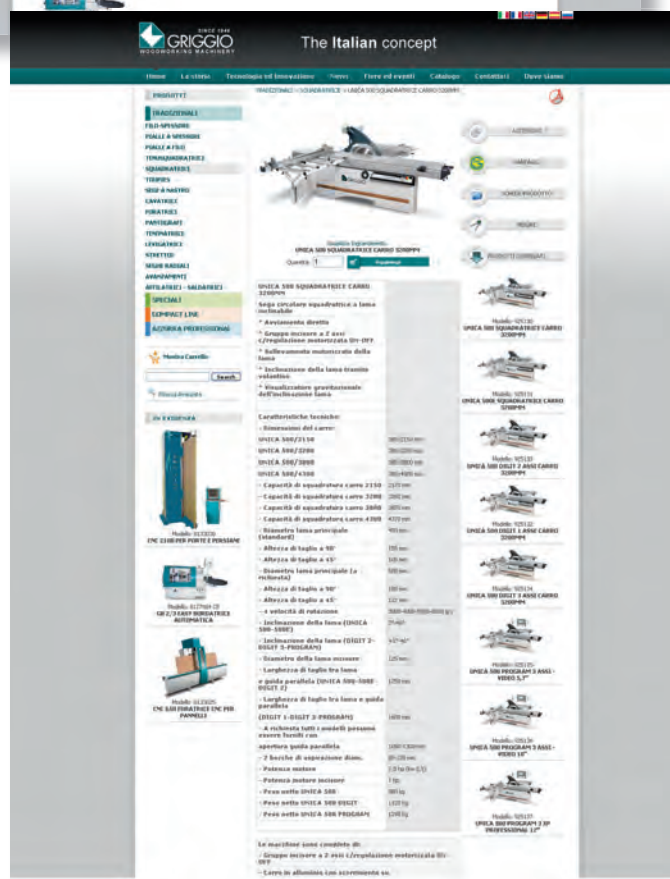
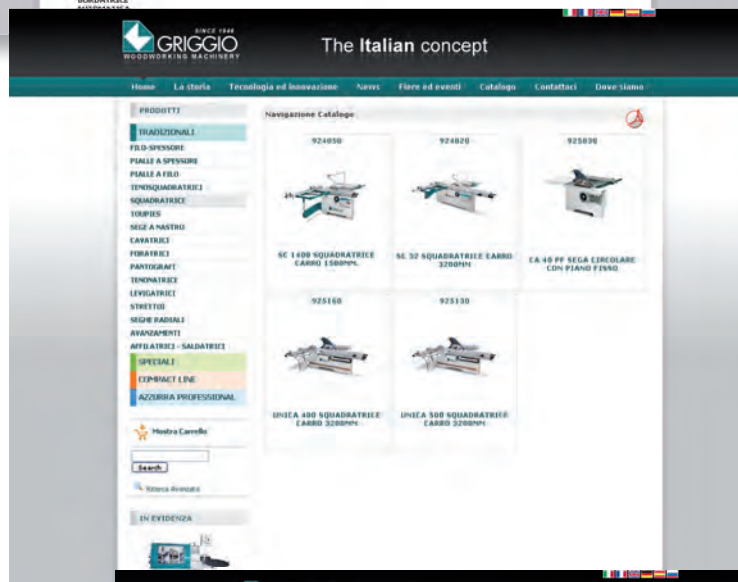
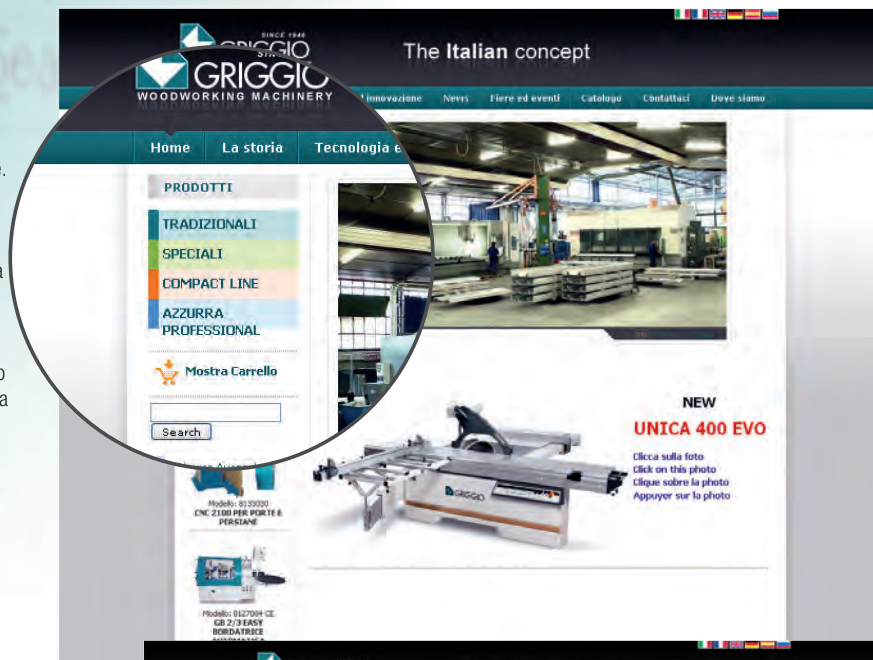

Linee di prodotto Firmate Griggio



Una linea dedicata all'industria, costituita da prodotti altamente tecnologici e conformi ai più elevati standard di sicurezza. Una gamma ergonomica e innovativa che garantisce la riduzione dei tempi di messa a punto e la precisione in ogni lavorazione.

Une série consacrée à l'industrie, composée par des produits fortement technologiques et conformes aux plus hauts niveaux de sécurité. Une gamme ergonomique et innovatrice qui garantit la réduction des temps de mis à point et la précision dans chaque travail.

Una linea dedicata a la industria, constituida de productos altamente tecnologicos y conformes a los mas elevados estandard de seguridad. una gama ergonomica y innovador que garatiza la reduccion de los tiempo de puesta en marcha y la precision de cada trabajos.



Una linea dedicata alla piccola e media impresa, caratterizzata da una gamma completa di prodotti robusti e versatili in grado di offrire alte prestazioni e competitività nel prezzo, mantenendo elevati standard di sicurezza.

Une série consacrée à la petite et moyenne entreprise, caractérisée par une gamme complète de produits forts et éclectiques qui offrent de hautes prestations et qui sont énormément compétitifs dans le prix, en gardant des élevés standards de sécurité.

Una linea dedicata a la pequeña y media empresa, caracterizada de una gama completa de productos robustos y versatiles que pueden ofrecer una elevadas prestaciones y competitividad en el precio, con unos estandars elevados de seguridad.



Una linea dedicata agli artigiani dediti al lavoro professionale, che risponde alle esigenze di semplicità di utilizzo con prodotti curati nei dettagli e altamente affidabili.

Une série consacrée aux artisans qui font du travail professionnel. Cette gamme répond aux exigences de simplicité dans l'emploi avec des produits qui sont très fiables et très soignés dans les détails.

Una linea dedicata a los artesanos que hacen un trabajo profesional, que responde a las exigencias de simplicidad de uso con productos precisos en los detalles y muy fiables



Griggio nel mondo

Un Business con ramificazioni in tutto il mondo

Griggio Group è presente in tutto il mondo attraverso una propria rete di rivenditori qualificati, in grado di offrire al cliente le migliori soluzioni ed un servizio tecnico in loco. Il rivenditore autorizzato Griggio è una figura motivata e propositiva, sempre in accordo con le scelte aziendali; possiede conoscenze tecniche e una struttura adeguata per far fronte alle esigenze dei propri clienti.

Training pratico personalizzato

Griggio organizza training all'interno delle proprie aziende, su tutti i prodotti ed in particolare sui software installati. A questo scopo Griggio si avvale di un team di tecnici esperti che forniscono gli strumenti necessari per far comprendere in maniera semplice e chiara come le macchine funzionano. Una cultura aziendale nella quale, il cliente viene posto al centro.

Une Affaire avec des ramifications dans le monde entier

Le Griggio Groupe se présente dans le monde entier par un réseau de revendeurs qualifiés qui arrivent à offrir à leurs clients les solutions les meilleures et un service technique sur place. Le revendeur autorisé Griggio est une figure motivée et qui fait des propositions, toujours en accord avec les choix de la maison; il possède des connaissances techniques et une structure adéquate pour faire face aux exigences de ses clients.

Stage pratique personnalisé

A l'intérieur de ses maisons, Griggio arrange des stages à propos de ses produits et en particulier sur les logiciels installés. Pour cela, Griggio utilise une équipe de techniciens experts qui donnent les instruments nécessaires pour pouvoir comprendre d'une façon simple et claire comment les machines marchent. C'est une culture de l'entreprise où le client est mis au centre.

Un business con ramificaciones en todos el mundo

Griggio Group es en todos el mundo con una propia red de revendedores cualificados, que pueden ofrecer al cliente las mejores soluciones y un servicio técnico local. el revendedor autorizado Griggio es una figura motivada y constructivo, siempre en acuerdo con las elecciones empresariales; tiene conocimiento técnico y una estructura adecuada para cada exigencias del clientes.

Training pratico personalizzato

Griggio organizza training in proprie aziende, di tutti i prodotti e in particolare dei software installati. La Griggio ha un team di tecnici esperti che possono spiegare in maniera semplice come lavorano le macchine. Una cultura aziendale dove il cliente è al centro.



Training presso Griggio Spa

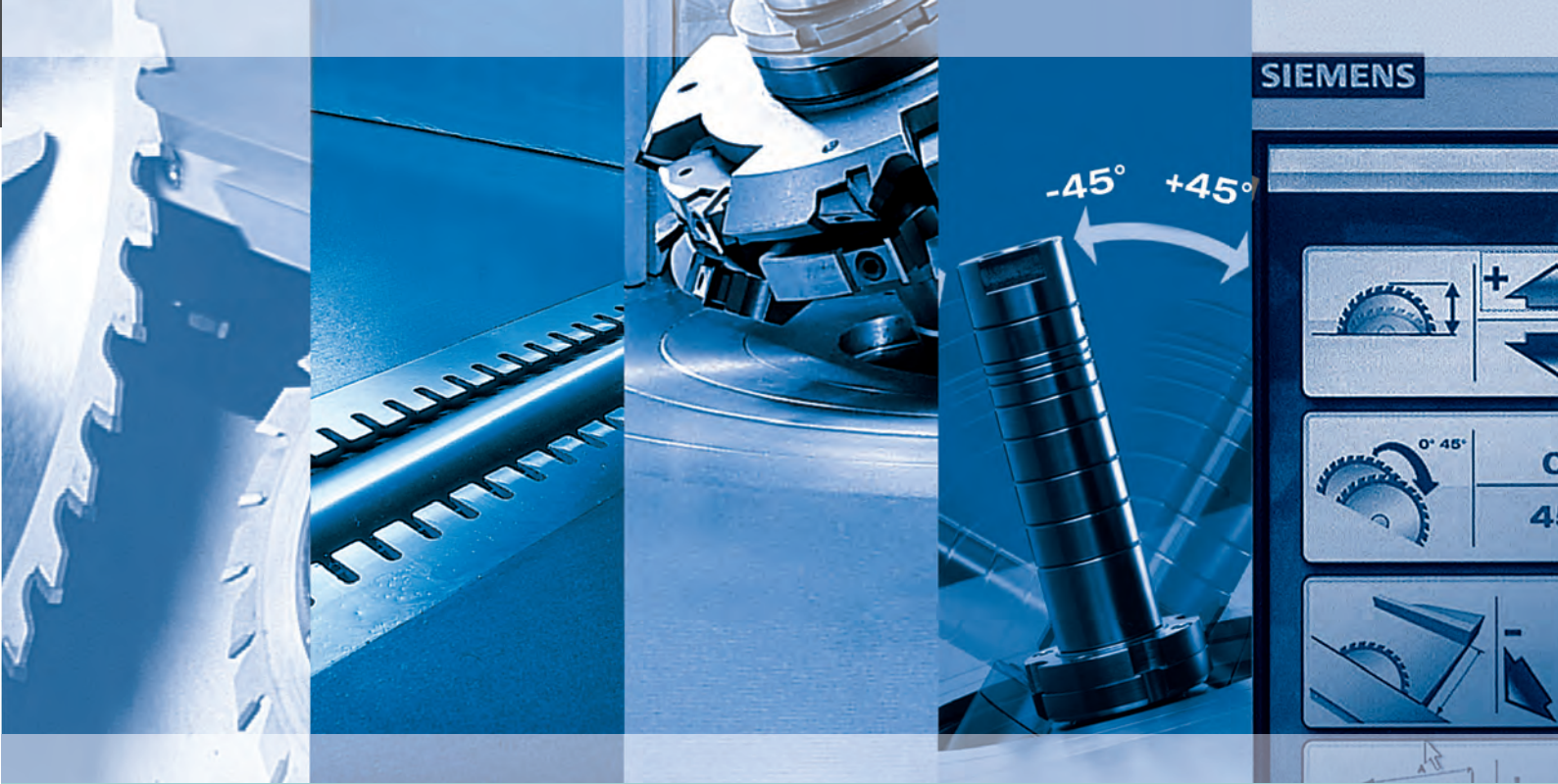

Macchine Tradizionali

Machines Traditionnelles
Máquinas Tradicionales





FS 530

FILO SPESSORE / DEGAUCHISSEUSE - RABOTEUSE CAPILLADORA - REGRUESADORA



DIGIT



Standard

Option

- Digit 1 asse Programmatore elettronico LCD posizionamento piano spessore
- Digit 1 axe Programmeur électronique LCD positionnement table rabot
- Digit 1 eje Programador electrónico LCD posicionamiento mesa regresos

Option

- Sollevamento pneumatico-idraulico
- Montée pneumatique-hydraulique
- Subida neumatica-hidraulica

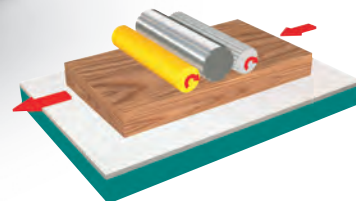

p 153

Dati tecnici

Données Techniques - Datos Tecnicos

FS 530

Dimensione dei piani di lavoro Dimensions de la table de travail Dimensiones de la mesa de trabajo	mm	530x2300
Piano spessore Table raboteuse Mesa a reguesar	mm	530x920
Min.-max. spessore utile Min.-maxi épaisseur utile Min.-max. altura a reguesar	mm	3-250
Max asportazione filo (Max.asportazione spessore) Maxi prise du bois degau (Max. asportacion raboteuse) Max asportacion cepillo (Max. asportacion regresos)	mm	8 (8)
Ø dell'albero pialla (Coltelli) Arbre dégauchisseuse Ø (Couteaux) Ø del eje (Cuchillas)	mm	120 (n°4)
Velocità di rotazione Vitesse de l'arbre Velocidad del eje	g/1' v/1' rpm	5000
Velocità avanzamento spessore Vitesse d'avancement raboteuse Velocidades de avances	m/1'	6-12
Motore Moteur Motor	KW (HP) KW (CV) KW (CV)	5,5(7,5)



Option

- N° 2 rulli sul piano
- N° 2 rouleaux sur la table
- N° 2 rodillos sobre la mesa



Option

- Protezione albero pieghevole in due parti "CE"
- Protecteur de l'arbre en deux pieces "CE"
- Protección eje partida en dos partes "CE"

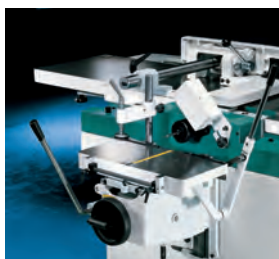

Option

- Gruppo cavatrice
- Groupe mortaiseuse
- Grupo de taladrar

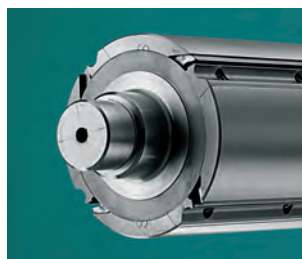

Option

- Albero "MONOBLOC" con coltelli Tersa
- Arbre "MONOBLOC" avec couteaux Tersa
- Eje "MONOBLOC" con cuchillas Tersa

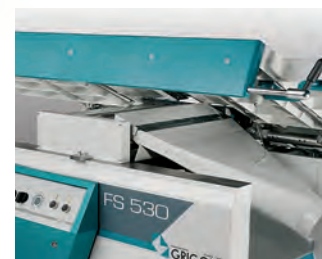

Standard

- Cappa di aspirazione
- Hotte d'aspiration
- Boca de aspiracion



FILO SPESSORE / DEGAUCHISSEUSE - RABOTEUSE CAPILLADORA - REGRUESADORA



CE

**Option**

N° 2 rulli sul piano

N° 2 rouleaux sur la table

N° 2 rodillos sobre la mesa

p 153

**Dati tecnici***Données Techniques - Datos Tecnicos***FS 410**

Dimensioni del piano di lavoro <i>Dimensions de la table de travail</i> Dimensiones de la mesa de trabajo	mm	410x2100
Piano spessore <i>Table raboteuse</i> Mesa a reguesar	mm	410x800
Min/max spessore utile <i>Min/max épaisseur utile</i> Min/max altura a reguesar	mm	9-240
Max asportazione filo (Max.asportazione spessore) <i>Maxi prise du bois degau (Max. asportacion raboteuse)</i> Max asportacion cepillo (Max. asportacion regueso)	mm	6 (7)
Ø dell'albero pialla (Coltelli) <i>Arbre dégauchisseuse Ø (Couteaux)</i> Ø del eje (Cuchillas)	mm	100 (n°3)
Velocità di rotazione dell'albero <i>Vitesse de l'arbre</i> Velocidad del eje	g/1' r/1'	5000
Velocità avanzamento spessore <i>Vitesse d'avancement raboteuse</i> Velocidades de avances	m/1'	6-12
Motore <i>Moteur</i> Motor	KW (HP) KW (CV) KW (CV)	3 (4)

**Standard**

- Visualizzatore delle quote
- *Affichage mécanique des cotes*
- Visualizador de las medidas

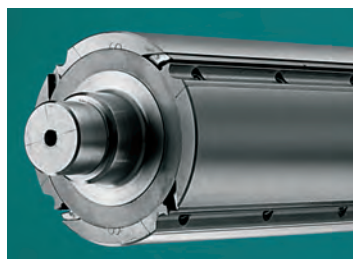
**Option**

- Albero "MONOBLOC" con coltelli Tersa
- *Arbre "MONOBLOC" avec couteaux Tersa*
- Eje "MONOBLOC" con cuchillas Tersa

**Option**

- Protezione albero pieghevole
- *Protecteur de l'albre*
- Protección eje partida

**Option**

- Gruppo cavatrice
- *Groupe mortaiseuse*
- Gruppo di taladrar



PSA 530

PIALLE A SPESSORE / RABOTEUSES / REGRUESADORAS

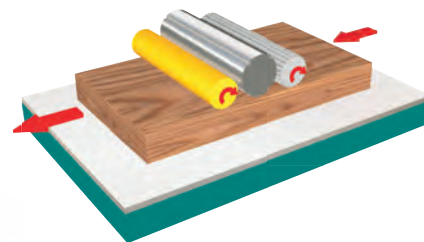

PSA 530

- 1 rullo di traino elicoidale in entrata
- rullo di traino in uscita ricoperto in gomma
- Pressoi registrabili
- Piano senza rulli
- 1 rouleau d'entraînement hélicoïdal en entrée
- 1 rouleau d'entraînement revêtu en ctc en sortie
- Presseurs enregistrables
- Table sans rouleaux
- 1 rodillo de arrastre helicoidal en entrada
- 1 rodillo de arrastre en salida recubierto en goma
- prensos registrables
- mesa sin rodillos

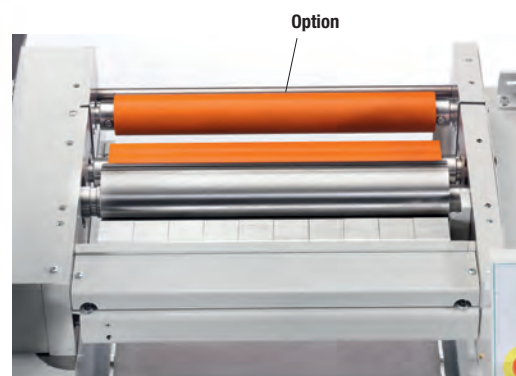

DIGIT



Standard

Option

- Digit 1 asse Programmatore elettronico LCD posizionamento piano spessore
- Digit 1 axe Programmateur électronique LCD positionnement table rabot
- Digit 1 eje Programador electrónico LCD posicionamiento mesa regrueso

p 153

Dati tecnici

Données Techniques - Datos Tecnicos

PSA 530

Dimensioni del piano di lavoro Dimensions de la table de travail Dimensiones de la mesa de trabajo	mm	530x920
Min. - max. altezza di lavoro Min. - maxi hauteur de travail Min.-max. altura de trabajo	mm	300(3)
Spessore max di asportazione Maxi prise du bois Espesor util max. de asportacion	mm	8
Diametro dell'albero (coltelli) Diamètre de l'arbre (Couteaux) Diametro del eje (Cuchillas)	mm	120(n°4)
Velocità di rotazione dell'albero Vitesse de l'arbre Velocidad del eje	g/1' r/1'	5000
N. 2 velocità di avanzamento con variatore N. 2 vitesses d'avancement avec variateur N. 2 velocidades de avance con variador	m/1'	6÷12
Variatore di Velocità (option) Variateur de vitesse (option) Variador de velocidad (a pedido)	m/1'	4-20
Motore Moteur Motor	KW (HP) KW (CV) KW (CV)	5,5 (7,5)

- Sollevamento del piano tramite 4 viti trapezoidali.
- Montée de la table par 4 vis trapézoïdales.
- subina de la mesa con 4 guida trapezoidale



Option

- N° 2 rulli sul piano
- N° 2 rouleaux sur la table
- N° 2 rodillos sobre la mesa



Option

- Albero "MONOBLOC" con coltelli Torsa
- Arbre "MONOBLOC" avec couteaux Torsa
- Eje "MONOBLOC" con cuchillas Torsa

PSA 630 / PSA 630 R



PIALLE A SPESSORE / *RABOTEUSES* / *REGRUESADORAS*



PSA 630

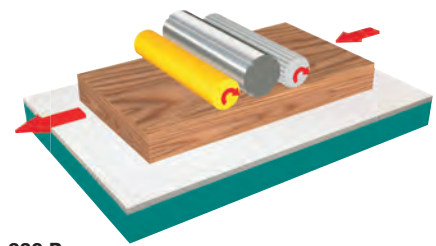

PSA 630 R

- 1 rullo di traino elicoidale in entrata
- rullo di traino in uscita ricoperto in gomma
- Pressoi registrabili
- Piano senza rulli
- 1 rouleau d'entraînement hélicoïdal en entrée
- 1 rouleau d'entraînement revêtu en ctc en sortie
- Presseurs enregistrables
- Table sans rouleaux
- 1 rodillo de arrastre helicoidal en entrada
- 1 rodillo de arrastre en salida recubierto en goma
- prensos registrables
- mesa sin rodillos

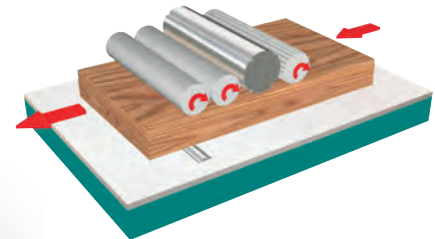

PSA 630

- 1 rullo di traino elicoidale in entrata • 2 rulli di traino in uscita • Pressoi registrabili • 1 rullo sul piano
- 1 rouleau d'entraînement hélicoïdal en entrée • 2 rouleaux d'entraînement en sortie • Presseurs enregistrables • 1 rouleau sur la table
- 1 rodillo de arrastre helicoidal en entrada • 2 rodillos de arrastre en salida • prensos registrables • 1 rodillo en la mesa



Option

- Albero "MONOBLOC" con coltelli Tersa
- Arbre "MONOBLOC" avec couteaux Tersa
- Eje "MONOBLOC" con cuchillas Tersa

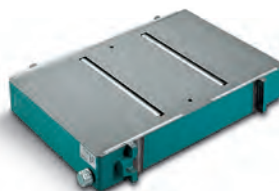

Option

- N° 2 rulli sul piano
- N° 2 rouleaux sur la table
- N° 2 rodillos sobre la mesa



- Altezza di lavoro min./max. 3/300 mm. Asportazione massima 8 mm.
- Hauteur de travail min./max. 3/300 mm. Asportation max. 8 mm.
- Altura de trabajo min./max. 3/300 mm. Espesor máximo 8 mm.

Standard

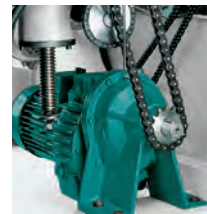

- Gruppo variatore HP 1,5
- Groupe variateur CV 1,5
- Grupo variador CV 1,5

DIGIT



Option

- Digit 1 asse Programmatore elettronico LCD posizionamento piano spessore
- Digit 1 axe Programmeur électronique LCD positionnement table rabot
- Digit 1 eje Programador electrónico LCD posicionamiento mesa regueso



- Variatore di velocità
- Velocità di avanzamento del pezzo variabile in continuo da 5-21 m/1'
- Permette di adeguare la velocità di avanzamento alle caratteristiche del materiale da lavorare
- Variateur de vitesse • Vitesse et avance de la pièce variable en continu de 5-21 m/1'
- Permet de conformer la vitesse d'avancement aux caractéristiques du matériel à usiner
- Variador de velocidad
- Velocidad de avance de la pieza variable en continuo de 5-21 m/1'
- Permite de adecuar la velocidad de avance según las características del material a trabajar

Standard

p 153

Dati tecnici		PSA 630	PSA 630 R
Données Techniques - Datos Tecnicos			
Dimensioni del piano di lavoro Dimensions de la table de travail Dimensiones de la mesa de trabajo	mm	630x1000	
Min.- max. altezza di lavoro Min.- maxi hauteur de travail Min.-max. altura de trabajo	mm	3-300	
Spessore max di asportazione Maxi prise du bois Espesor útil max. de asportación	mm	8	
Diametro dell'albero (coltelli) Diamètre de l'arbre (Couteaux) Diametro del eje (Cuchillas)	mm	120(n°4)	
Velocità di rotazione dell'albero Vitesse de l'arbre Velocidad del eje	g/1' t/1' r/1'	5000	
Velocità di avanzamento con variatore Vitesse d'avancement avec variateur Velocidades de avance con variador	m/1'	5÷21	
Motore avanzamento Moteur d'avancement Motor de avance	HP CV CV	1,5	
Motore Moteur Motor	KW (HP) KW (CV) KW (CV)	5,5 (7,5)	



PF 430 - PF 530R

PIALLE A FILO / DEGAUCHISSEUS / CEPILADORAS



PF 430
PF 530 R

CE

p 153



Dati tecnici

Données Techniques - Datos Tecnicos

		PF 430	PF 530 PF 530 R
Dimensioni del piano di lavoro <i>Dimensions de la table de travail</i> Dimensiones de la mesa de trabajo	mm	430x2750	530x2900
Lunghezza piano d'entrata <i>Longeur table d'entrée</i> Longitud mesa en entrada	mm	1500	1660
Lunghezza piano d'uscita <i>Longeur table de sortie</i> Longitud mesa en salida	mm	1200	1200
Dimensioni della guida <i>Dimensions du guide</i> Dimensiones de la guía	mm	1350x170	1350x170
Max. asportazione <i>Maxi prise du bois</i> Max. asportacion	mm	8	8
Velocità di rotazione dell'albero <i>Vitesse de rotation de l'arbre</i> Velocidades del eje	g/1' t/1' r/1'	5000	5000
Dia. dell'albero porta coltelli (Coltelli) <i>Dia. de l'arbre porte-couteaux (Couteaux)</i> Dia. l. porta cuchillas (Cuchillas)	mm (n°)	120 (n°4)	120 (n°4)
Motore <i>Moteur</i> Motor	KW(HP) KW(CV) KW(CV)	3 (4)	4 (5,5)





PIALLE A FILO / DEGAUCHISSEUS / CEPILADORAS



PF 530

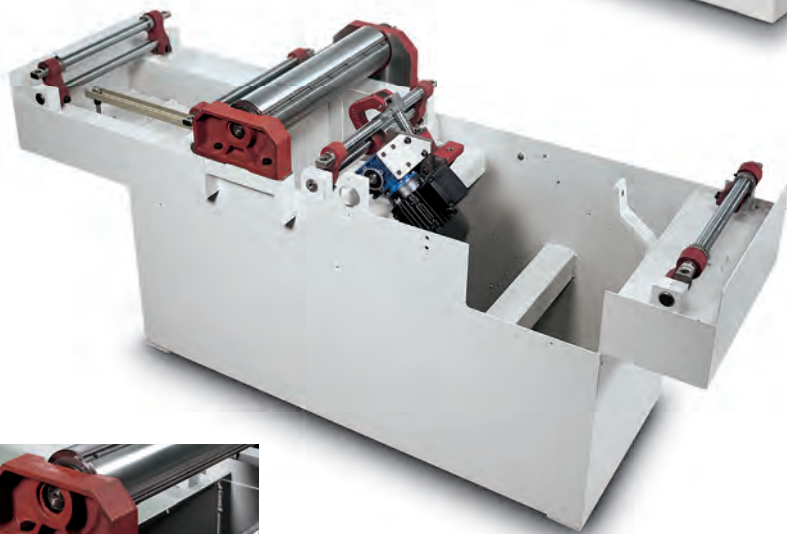

Standard PF 530

- Regolazione del piano in entrata motorizzato
Reglage de la table en entrée motorisé
Reguatiòn s de la mesa en entrada motorizada
- Visualizzatore digitale elettronico delle quote
Afficheur électronique des côtes
Visualizador digital electrónico de las cotas

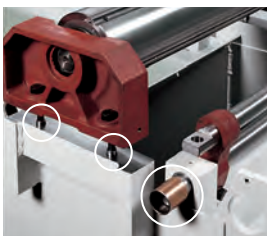

Option
Albero "MONOBLOC" con coltelli Tersa
Arbre "MONOBLOC" avec couteaux Tersa
Eje "MONOBLOC" con cuchillas Tersa



Standard BASIC
Protezione albero BASIC
Protecteur de l'albre BASIC
Proteccion eje BASIC



Standard PF 530
Option PF 430 / PF 530 R
Protezione albero pieghevole in due parti "CE"
Protecteur de l'albre en deux pièces
Proteccion eje partida en dos partes "CE"



Option
Gruppo cavatrice
Groupe mortaiseuse
Grupo de taladrar



TS 150 - TS 300

TENOSQUADRATRICI A LAMA INCLINABILE
 TENNONEUSES-EQUADRISSEUSES AVEC LAME INCLINABLE
 SIERRAS-TUPIS ESCUADRADORAS CON DISCO INCLINABLE

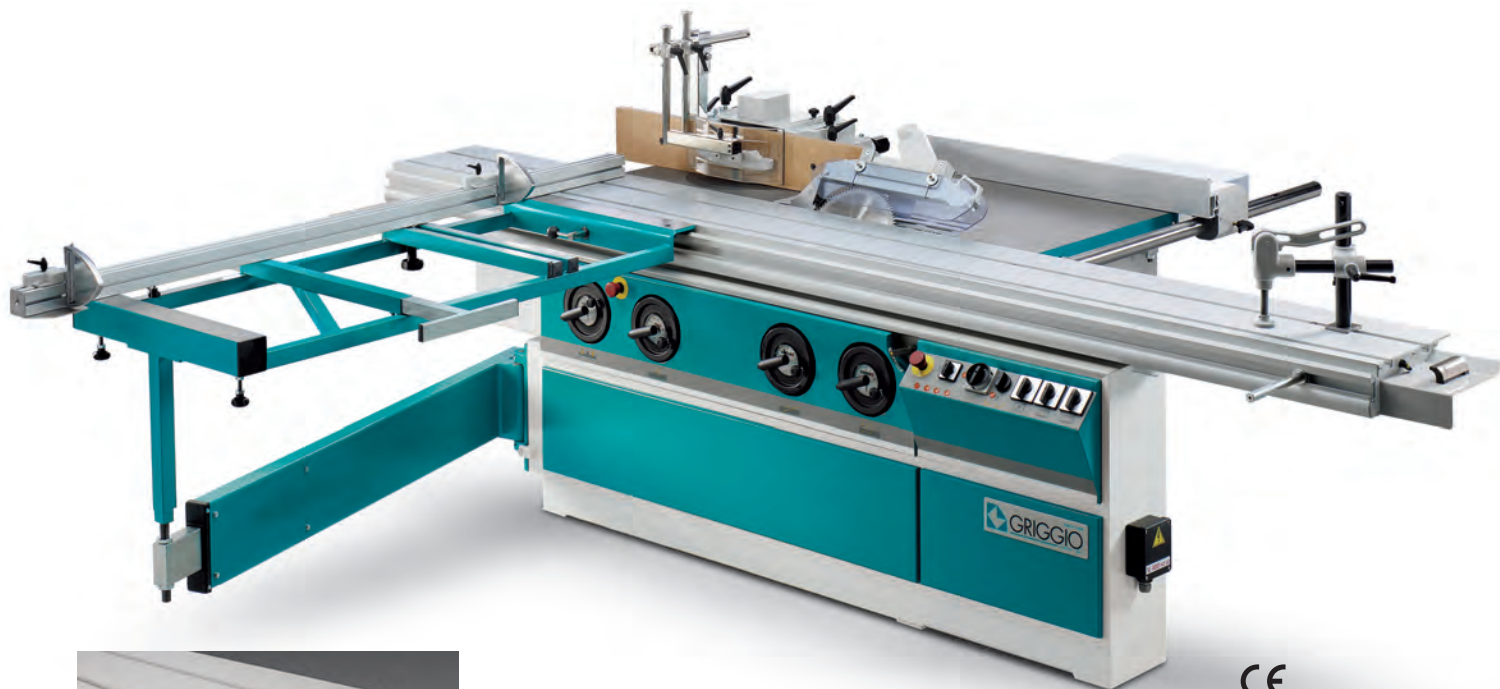

CE

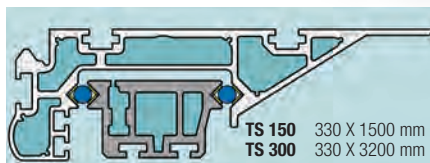

p 153

Dati tecnici

Données Techniques - Datos Tecnicos

TS 150
 TS 300

Dimensione del carro Dimensions du chariot Medidas del carro	mm	330x1500 330x2000 330x3200
Lunghezza di taglio della lama Longeur de coupe de la lame Largo de corte del disco	mm	1550 2050 3300
Larghezza di taglio fra lama e guida parallela Largeur de coupe avec le guide Ancho de corte entre disco y tope paralelo	mm	1000
Altezza di taglio con lama Ø 300 (Ø 350) Hauteur de coupe avec lame Ø 300 (Ø 350) Altura de corte con disco Ø 300 (Ø 350)	mm	80 (118)
Ø lama (a richiesta) Ø de la lame (sur demande) Ø disco (a pedido)	mm	300 (350)
Velocità di rotazione Vitesse de rotation Velocidades del eje	g./1' t./1' r/1'	4000
Spostamento trasversale della lama Course trasversale de la lame Recorrido trasversal disco	mm	140
Potenza motore lama principale Puissance moteur lame principale Potencia motor disco principal	KW (HP) KW (CV) KW (CV)	4(5,5)
Gruppo incisore-Grupos inciseur-Grupo incisor		
Ø della lama / Ø de la lame / Ø disco		100
Gruppo toupie-Grupos toupie-Grupo tupi		
Albero: lunghezza utile Arbre: longueur utile Eje: largo útil	Ø / mm	Ø 30-35/140 Ø 40-50/150
Velocità di rotazione Vitesse de rotation Velocidad de rotación	g./1' t./1' r/1'	3200-4200 6000-8000
Potenza motore Puissance moteur Potencia motor	KW (HP) KW (CV) KW (CV)	4 (5,5)



Option



Option



Option



Seghe circolari squadratrici

Scies a format
Escuadradoras



**HIGH
QUALITY
RANGE**



SC 32

SQUADRATRICI A LAMA INCLINABILE SCIES À FORMAT À LAME INCLINABLE ESCUADRADORAS CON DISCO INCLINABLE

Option

Visualizzatore elettronico guida estensibile
Affichage électronique guide extensible
Lector electrónico guía extensible

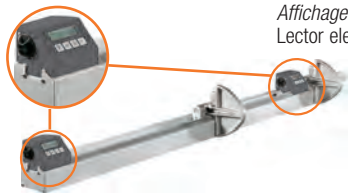

SC 32/315

CE

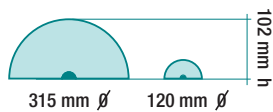

Option

Visualizzatore elettronico guida estensibile
Affichage électronique guide extensible
Lector electrónico guía extensible

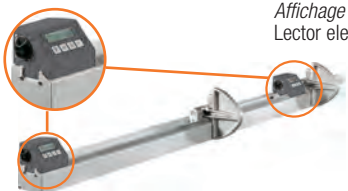

SC 32/350

CE

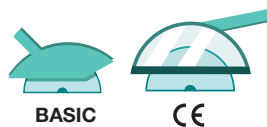
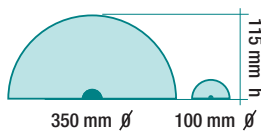

SC 1400



CE

SC 1400/315 CE

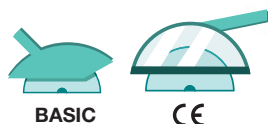
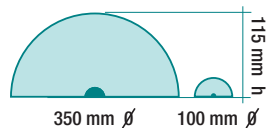
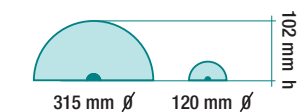

OPTIONS

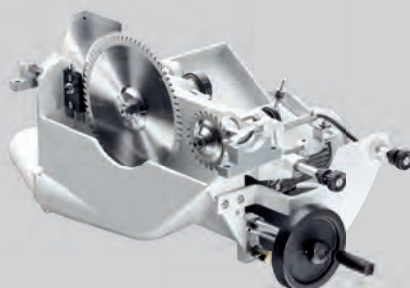

Option



Standard

p 153



Dati tecnici

Données Techniques - Datos Tecnicos

		SC 32	SC 1400
Dimensione del carro Dimensions du chariot Medidas del carro	mm	330x2600 330x3200	330x1500 330x2000
Capacità di squadratura con incisione Capacité d'équarrissage avec inciseur Capacidad de escuadrar con incisor	mm	2650 3250	1600 2100
Larghezza di taglio fra lama e guida parallela Largeur de coupe entre lame et guide parallèle Ancho de corte entre disco y tope paralelo	mm	1050	1050
Ø della lama (a richiesta) Ø de la lame (sur demande) Ø del disco (a pedido)	mm	CE BASIC 315 (350)* 350	CE BASIC 315 (350)* 350
Altezza di taglio Hauteur de coupe Altura de corte	mm	93 (118)*	93 (118)*
Altezza di taglio con lama a 45° Hauteur de coupe avec lame à 45° Altura de corte con disco de a 45°	mm	55 (80)*	55 (80)*
Lama inclinabile Lame inclinable Disco inclinable hasta		0-45°	0-45°
Ø dell'albero porta lama Ø de l'arbre porte lame Ø del eje disco	mm	30	30
Dia. della lama incisore Dia. de la lame inciseur Dia. del disco incisor	mm	CE BASIC 120 (100)* 100	CE BASIC 120 (100)* 100
Velocità di rotazione dell'albero Vitesses de rotation de l'arbre Velocidades de rotación del eje	g/1' r/1' r/1'	4000	4000
Motore Moteur Motor	KW (HP) KW (CV) KW (CV)	4 (5,5)	4 (5,5)

* (Option)



Option

Squadra in alluminio + 30° - 45°
Guide en aluminium + 30° - 45°
Eescuadra en aluminio + 30° - 45°



Option



Option

Lettoere elettronico posizione della guida parallela
Lecteur électronique position de la règle sur la table
Lector electrónico posicionamiento tope paralelo



Protezione BASIC
Protecteur BASIC
Protección BASIC



CA 40 - CA 40 PF

SEGA CIRCOLARE SQUADRATRICE A LAMA INCLINABILE
 SCIE A FORMAT À LAME INCLINABLE
 ESCUADRADORA CON DISCO INCLINABLE

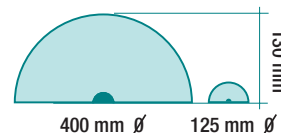

CA 40



CA 40 PF

Option



Standard



Option

Squadra in alluminio + 30° - 45°
 Guide en aluminium + 30° - 45°
 Escuadra en aluminio + 30° - 45°



Protezione BASIC
 Protecteur BASIC
 Protección BASIC



Option

Letto elettronico posizione della guida parallela
 Lecteur électronique position de la règle sur la table
 Lector electrónico posicionamiento tope paralelo

p 153

Dati tecnici

Données Techniques - Datos Tecnicos

CA 40

		CA 40
Dimensioni del carro (a richiesta) Dimensions du chariot (sur demande) Medidas del carro (a pedido)	mm	330x1500
Capacità di squadratura con incisione Capacité d'équarrissage avec inciseur Capacidad de escuadrar con incisor	mm	1500
Larghezza di taglio fra lama e guida parallela (a richiesta) Largeur de coupe entre lame et guide parallèle (sur demande) Ancho de corte entre disco y tope paralelo (a pedido)	mm	1050
Ø della lama Ø de la lame Ø disco	mm	400
Altezza di taglio (a richiesta) Hauteur de coupe (sur demande) Altura de corte (a pedido)	mm	130
Altezza di taglio con lama 45° Ø Hauteur de coupe avec lame 45° Ø Altura de corte con disco a 45° Ø	mm	90
Lama inclinabile / Lame inclinable / Disco inclinable	mm	0°-45°
Velocità di rotazione dell'albero (a richiesta) Vitesse de rotation de l'arbre (sur demande) Velocidad de rotación del eje (a pedido)	g/1' t/1' r/1	4000 (3200-4000-6000)CE
Motore - Motor - Moteur	Kw (HP) CV	4(5,5)
Gruppo Incisore / Groupe inciseur / Grupo incisor		
Ø della lama / Ø de la lame / Ø disco	mm	125
Motore - Motor - Moteur	Kw (HP) CV	0,75 (1)



GRIGGIO SINCE 1946
WOODWORKING MACHINERY



UNICA LINE



UNICA PROGRAM



UNICA DIGIT



UNICA EVO



UNICA E



UNICA

Seghe circolari squadratrici

Scies a format / Escuadradoras



Carro / Chariot / Carro

Dal 1990 la Griggio Spa produce il carro in alluminio scorrevole su guide a barre in acciaio temprato e rettificato.

Dès 1990, la maison Griggio Spa produit le chariot en aluminium glissant sur guides à barres en acier trempé et rectifié.

Desde el 1990 Griggio Spa produce el carro en aluminio con desplazamiento en guías a barras en acero templado y rectificado.

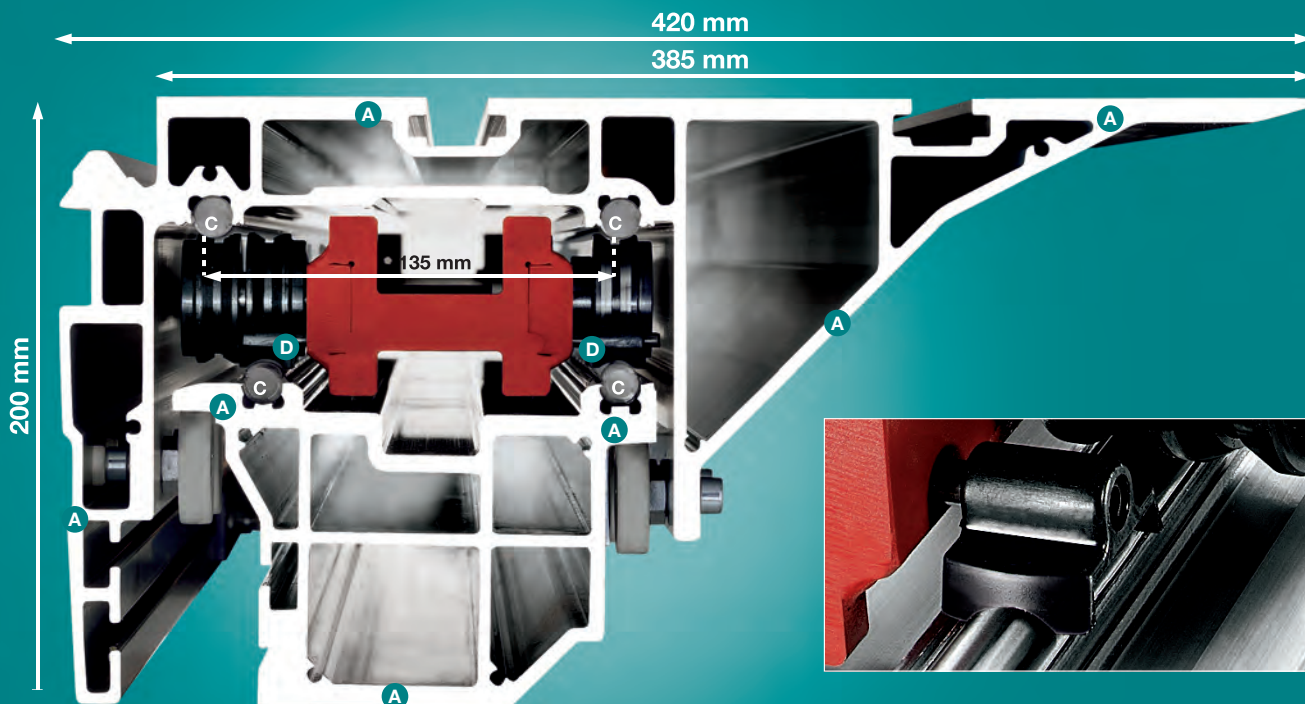

Cambio lama veloce.

Il cambio della lama si effettua in modo veloce azionando la leva (1) e facendo scorrere il carro oltre la lama stessa, lasciando completamente libero l'accesso (2)

Changement rapide de la lame.

Le changement de la lame se réalise rapidement en actionnant le levier (1) et en faisant glisser le chariot outre la lame même, en laissant complètement libre l'accès (2)

Cambio disco rápido.

El cambio del disco es rápido accionando la palanca (1) y desplazando el carro se deja completamente libre el cuerpo máquina (2)

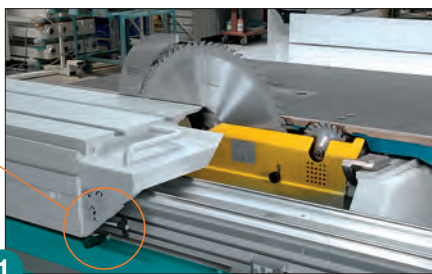
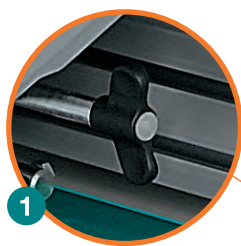

VANTAGGI!

Avantages! / ! Ventajas!

- Il sistema di scorrimento consente di ottenere la massima precisione e rettilineità
- A)** Struttura del carro superiore ed inferiore con nervature per aumentarne la solidità e la stabilità
- B)** Doppio rullo di scorrimento sul lato esterno. Indispensabile sui carri di lunghezza superiore a 2500 mm
- C)** Le barre in acciaio temprato e rettificato di alta precisione vengono fissate sul carro con un ampio interasse di 135 mm. Assicura una maggiore stabilità.
- D)** N° 8 raschiatori (pulitori) con spigolo tagliente per una perfetta pulizia delle guide di scorrimento
- Facilità di registrazione e pulizia

Le système de glissement permet d'obtenir une précision maxi et rectilinéaire.

- A)** Structure du chariot supérieur et inférieur avec nervures pour en augmenter la solidité et la stabilité
- B)** Double rouleau de glissement sur la cote extérieure. Il est indispensable sur les chariots de longueur supérieure à 2500 mm.
- C)** Les barres en acier trempées et rectifiées à hautes précision sont fixées sur le chariot par un vaste interaxe de 135 mm. Ce système assure une majeure stabilité.
- D)** N° 8 racleurs (nettoyeurs) avec angle tranchant pour un parfait nettoyage des guides de glissement.
- Facilité d'enregistrement et nettoyage

El sistema de desplazamiento permite la máxima precisión y rectilineidad

- A)** Estructura del carro superior y inferior con nervaduras para aumentar la solidez y la estabilidad
- B)** Doble rodillo de desplazamiento en el lado exterior. Necesario en los carros de largo superior a 2500 mm
- C)** Barras en acero templado y rectificado de elevada precisión fijados en el carro con un entre-eje de 135 mm. Esto sistema asegura una mayor estabilidad
- D)** N°8 rascadores (limpiadores) canto cortante para una perfecta limpieza de las guías de desplazamientos
- Facilidad de registraci3n y limpieza

UNICA LINE



Il carro viene totalmente prodotto su centro di lavoro a controllo numerico Sistema di qualità certificato ISO 9001

Le chariot est totalement produit sur un centre de travail à contrôle numérique Système de qualité certifié ISO 9001

El carro es producido en centro de trabajo a control numerico. Sistema de calidad certificado ISO 9001



GRIGGIO
6
YEARS
WARRANTY

UNICA 350 option
UNICA 400/500 standard
Bloccaggio Carro in tutte le posizioni
Bloccage du chariot dans toutes les positions
Bloqueo carro en todas las posiciones

Tolleranza massima di taglio 0,5 mm
Tolérance maximale de coupe 0,5 mm
Tolerancia maxima de corte 0,5 mm

UNICA 350-315 / UNICA 350

**Gruppo lama
inclinabile,
completamente
in ghisa.**

**Groupe scie
inclinable
complètement
en fonte.**

**Grupo sierra
inclinable,
completamente
en fundación.**

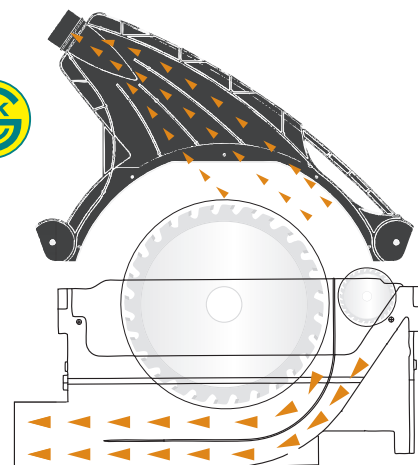
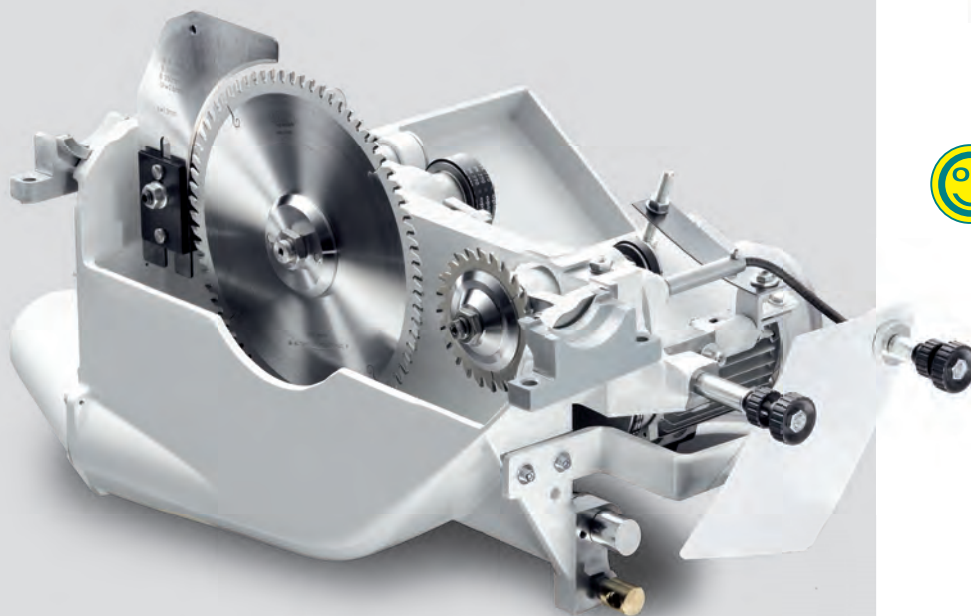

Aspirazione incisore
Aspiration inciseur
Aspiracion incisor



Standard



Standard



Option
Squadra in alluminio + 30° - 45°
Guide en aluminium + 30° - 45°
Eascuadra en aluminio + 30° - 45°



Option
Lettore elettronico posizione
della guida parallela
Lecteur électronique position
de la règle sur la table
Lector electrónico posicionamiento
tope paralelo



UNICA 350



UNICA 350-315
Protezione BASIC
Protecteur BASIC
Protección BASIC



DC01

Scoring Unit UNICA 350-315 / 350

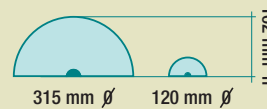
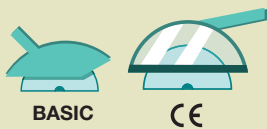
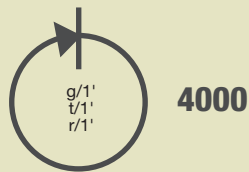

	mm	mm	mm
Ø Lama Ø Lame Ø Disco	250	300	350
Altezza di taglio 90° Hauteur de coupe à 90° Altura de corte à 90°	55	93	118
Altezza di taglio 45° Hauteur de coupe à 45° Altura de corte à 45°	35	55	80
Sporgenza lama dal piano di lavoro con lama completamente abbassata Saillie lame de la table d'usinage avec lame complètement baissée Salida disco de la mesa de trabajo con disco completamente bajado	0	0	25
Spessore coltello diviso Epaisseur couteau diviseur Espesor cuchilla divisora	2,8	2,8	3
Ø lama incisore Ø de la lame incisor Ø del disco incisor	120	120	100

SCORING UNIT STANDARD UNICA 350 - UNICA 350/315

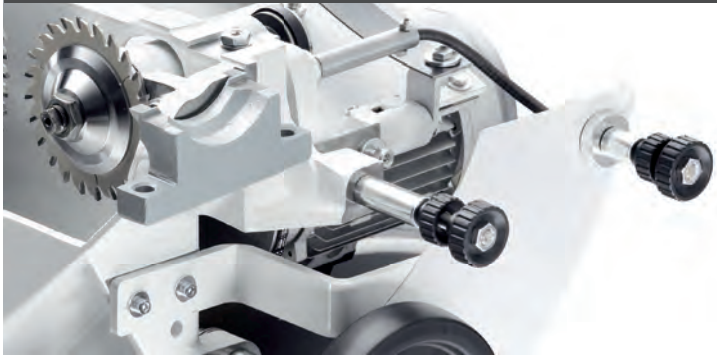

SCORING UNIT STANDARD UNICA 350 E - 350/315 E - EVO - DIGIT

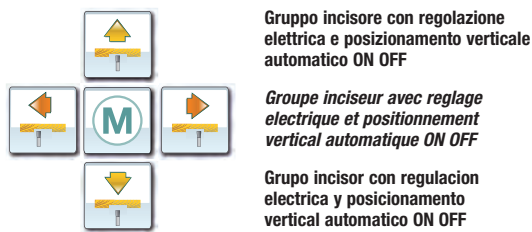

Gruppo incidere con regolazione elettrica e posizionamento verticale automatico ON OFF

Grupos incidere con regulación eléctrica y posicionamiento vertical automático ON OFF

Grupos incidere con regulación eléctrica y posicionamiento vertical automático ON OFF

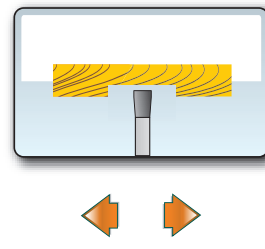

p 153



Dati tecnici

Données Techniques - Datos Tecnicos

		UNICA 350	UNICA 350/315
Dimensione del carro / Dimensions du chariot / Medidas del carro	mm	330x2600 330x3200	330x2600 330x3200
Capacità di squadratura con incisione / Capacité d'équarrissage avec inciseur / Capacidad de escuadrar con incisor	mm	2650 3250	2700 3260
Larghezza di taglio fra lama e guida parallela / Largeur de coupe entre lame et guide parallèle / Ancho de corte entre disco y tope paralelo	mm	1050	1050
Ø della lama (a richiesta) / Ø de la lame (sur demande) / Ø del disco (a pedido)	mm	350	CE 315 BASIC 350
Altezza di taglio / Hauteur de coupe / Altura de corte	mm	118	CE 93 BASIC 118
Altezza di taglio con lama a 45° / Hauteur de coupe avec lame à 45° / Altura de corte con disco de a 45°	mm	80	CE 55 BASIC 80
Lama inclinabile / Lame inclinable / Disco inclinabile hasta		0-45°	0-45°
Ø dell'albero porta lama / Ø de l'arbre porte lame / Ø del eje disco	mm	30	30
Dia. della lama incisore / Dia de la lame inciseur / Dia. del disco incisor	mm	100	CE 120 BASIC 100
Velocità di rotazione dell'albero / Vitesses de rotation de l'arbre / Velocidades de rotación del eje	g/1' / t/1 / r/1	4000	4000
Motore / Moteur / Motor	KW (HP) / KW (CV)	4 (5,5)	4 (5,5)



UNICA 350 / UNICA 350 - 315

SEGHE CIRCOLARI SQUADRATRICI A LAMA INCLINABILE
 SCIES A FORMAT À LAME INCLINABLE
 ESCUADRADORAS CON DISCO INCLINABLE

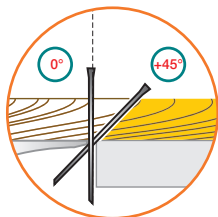

CE

UNICA 350

Standard:

- Sollevamento e inclinazione della lama tramite volantino.
- Visualizzatore gravitazionale dell'inclinazione lama
- Incisore manuale

Standard:

- *Montée et inclination de la lame par volant*
- *Afficheur gravitationnel de l'inclination de la lame*
- *Inciseur manuel*

Standard:

- Subida y Inclinación del disco por volante.
- Visualizador gravitacional de la inclinación disco
- Incisor manual

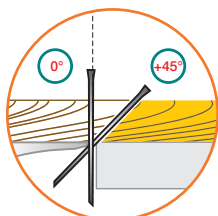
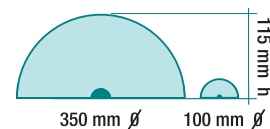

CE

UNICA 350 - 315

Standard:

- Sollevamento e inclinazione della lama tramite volantino.
- Visualizzatore gravitazionale dell'inclinazione lama
- Incisore manuale

Standard:

- *Montée et inclination de la lame par volant*
- *Afficheur gravitationnel de l'inclination de la lame*
- *Inciseur manuel*

Standard:

- Subida y Inclinación del disco por volante.
- Visualizador gravitacional de la inclinación disco
- Incisor manual

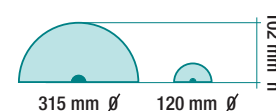

UNICA 350 E / UNICA 350 - 315 E

SEGHE CIRCOLARI SQUADRATRICI A LAMA INCLINABILE
 SCIES A FORMAT À LAME INCLINABLE
 ESCUADRADORAS CON DISCO INCLINABLE

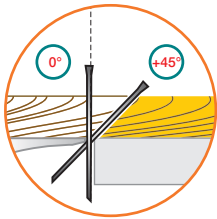

Option

CE

UNICA 350 E

Standard:

- Sollevamento motorizzato della lama
- Inclinazione motorizzata della lama con visualizzatore digitale elettronico LCD
- Incisore motorizzato

Standard:

- Montée motorisée de la lame
- Inclinasion motorisée de la lame avec afficheur digitale électronique LCD
- Inciseur motorisé

Estandard:

- Subida motorizada disco
- Inclinación motorizada disco con visualizador digital electrónico LCD
- Incisor motorizado

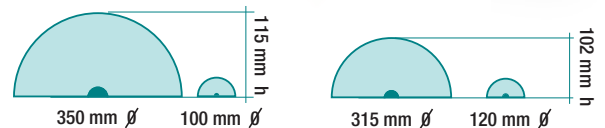

Option

Avviamento su carro scorrevole
 Démarrage sur charriot
 Arranque automatico dal carro



Option

Carro squadratore con estensione telescopica
 Extension telescopiquechariot equarisseur
 Extension telescopicaacarro equadrador



Compensazione misure con visualizzazione elettronica
 Compensation de la mesure avec affichage électronique
 Compensacion medidas con visualizacion electronica

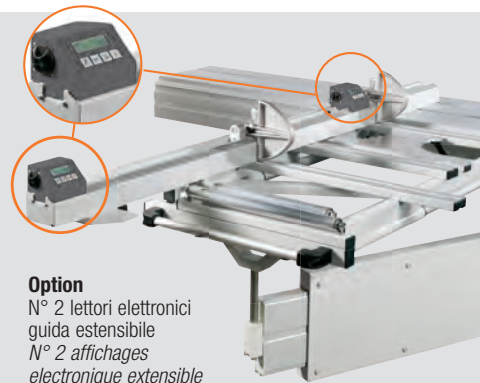

Option

N° 2 lettori elettronici guida estensibile
 N° 2 affichages électronique extensible
 N° 2 lectores electronicos guía extensible



Option

Bloccaggio carro in tutte le posizioni / Blocage du chariot dans toutes les positions
 Bloqueo carro en todas las posiciones



Option UNICA 350-350/315 Standard UNICA E-EVO-DIGIT
 Inclinazione guida estensibile con compensazione della misura del fermo battuta

Inclinasion du guide extensible avec compensation de la mesure de la butée d'arrêt

Inclinacion guía extensible con compensacion de la medida del tope

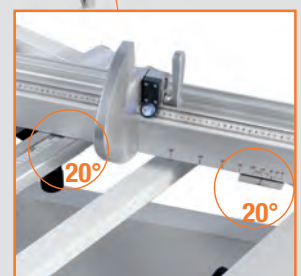



UNICA 350 EVO

SEGHE CIRCOLARI SQUADRATRICI A LAMA INCLINABILE CON GUIDA PARALLELA MOTORIZZATA
 SCIES A FORMAT À LAME INCLINABLE AVEC GUIDE PARALLÈLE MOTORISÉE
 ESCUADRADORAS CON DISCO INCLINABLE CON TOPE PARALELO MOTORIZADA

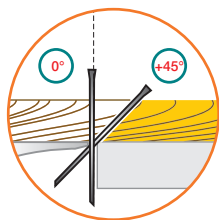

Option



UNICA 350 EVO



Guida parallela montata su guida lineare con pattini a ricircolo di sfere e trasmissione mediante vite trapezoidale e rettificata
Guide parallèle montée sur guide linéaire équipée de patins à recercle de billes et transmission par vis trapézoïdale et rectifiée
 Guía paralela puesta en guías lineares a patines a recirculo de bolas y transmisión por tornillo trapezoidal y rectificado



option



Visualizzatore digitale elettronico LCD sollevamento lama
Afficheur digitale électronique LCD monté de la lame
 Visualizador digital electrónico LCD subida disco

Standard:

- Sollevamento motorizzato della lama
- Inclinazione motorizzata della lama con visualizzatore digitale elettronico LCD
- Incisore motorizzato
- Scorrimento della guida lineare con pattini a ricircolo di sfere.
- Guida parallela motorizzata a 2 velocità con posizionamento decimale e visualizzazione digitale elettronico LCD

Equipement de série:

- *Montée motorisée de la lame*
- *Inclinaison motorisée de la lame*
- *Afficheur digitale électronique LCD*
- Inciseur motorisé
- *Glissement du guide parallèle sur une barre trempée et rectifiée avec support glissement guide à recercle de billes*
- *Guide parallèle avec positionneur électronique avec afficheur digitale électronique LCD*

Estandard:

- Subida motorizada disco
- Inclinación motorizada disco con visualizador digital electrónico LCD
- Incisor motorizado
- Deslizamiento tope paralelo en barra templada y rectificada con soporte a recirculo de bolas
- Tope paralelo con posicionador electrónico con visualizador digital electrónico LCD

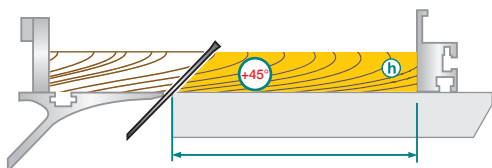

UNICA 350 DIGIT 3

SEGA CIRCOLARE SQUADRATRICE A LAMA INCLINABILE
 CON PROGRAMMATTORE ELETTRONICO A 3 ASSI
SCIE À FORMAT À LAME INCLINABLE AVEC PROGRAMMATEUR ÉLECTRONIQUE À 3 AXES
 ESCUADRADORA A DISCO INCLINABLE CON PROGRAMATOR ELECTRONICO A 3 EJES

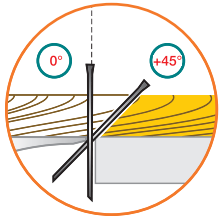

Option



Guida parallela montata su guida lineare con pattini a ricircolo di sfere e trasmissione mediante vite a ricircolo di sfere
Guide parallèle monté sur guide linéaire équipée de patins à recircule de billes et transmission par vis à recircule de billes
 Guía paralela montada en guía lineal con patines a recirculo de bolas y transmisión por tornillos a recirculo de bola

UNICA 350 DIGIT 3



DIGIT 3 - Touch screen

Digit 3:

- Possibilità di memorizzare fino a 500 programmi di lavoro
- Posizionamento elettronico dell'altezza e dell'inclinazione della lama con correzione automatica dell'altezza in rapporto all'inclinazione.
- Guida parallela con posizionatore elettronico e visualizzazione digitale dell'inclinazione lama con compensazione del posizionamento della guida con lama inclinata. Calcolo automatico della quota superiore ed inferiore del pannello da tagliare (A-B).
- Incisore motorizzato

Digit 3:

- Possibilité de mémoriser jusqu'à 500 programmes de travail
- Positionneur électronique de la hauteur et de l'inclinaison de la lame avec correction automatique par rapport à l'inclinaison
- Guide parallèle avec positionneur électronique et afficheur digitale d'inclinaison de la lame avec compensation du positionnement du guide avec lame inclinée. Calcul automatique de la mesure supérieure et inférieure du panneau (A-B).
- Inciseur motorisé

Digit 3:

- Posibilidad de memorizar hasta 500 programas de trabajo
- Posicionamiento electrónico altura y inclinación disco con corrección automática de la altura en relación a la inclinación
- Tope paralelo con posicionador electrónico y visualizador digital de la inclinación disco con compensación del posicionamiento del tope con disco inclinado. Cálculo automático de la medida superior y inferior de la pieza a cortar (A-B).
- Incisor motorizado

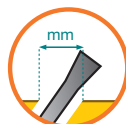
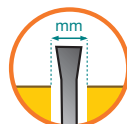
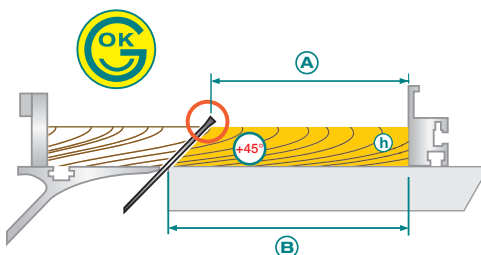

Guida parallela con posizionatore elettronico con compensazione del posizionamento con lama inclinata.

Guide parallèle avec positionneur électronique avec compensation du positionnement avec lame inclinée.

Tope paralelo con posicionador electrónico con compensación del posicionamiento con disco inclinado.

UNICA 400

Gruppo lama inclinabile, completamente in ghisa. Sollevamento lama su guide lineari e pattini a ricircolo di sfere

Groupe scie inclinabile complètement en fonte. Montée de la lame sur guide lineaire et patins a recirculation de billes

Grupo sierra inclinabile, completamente en fundación. Subida disco en guías lineares y guía a recirculo de bolas

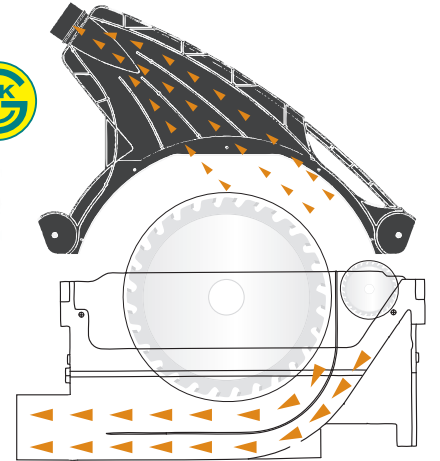
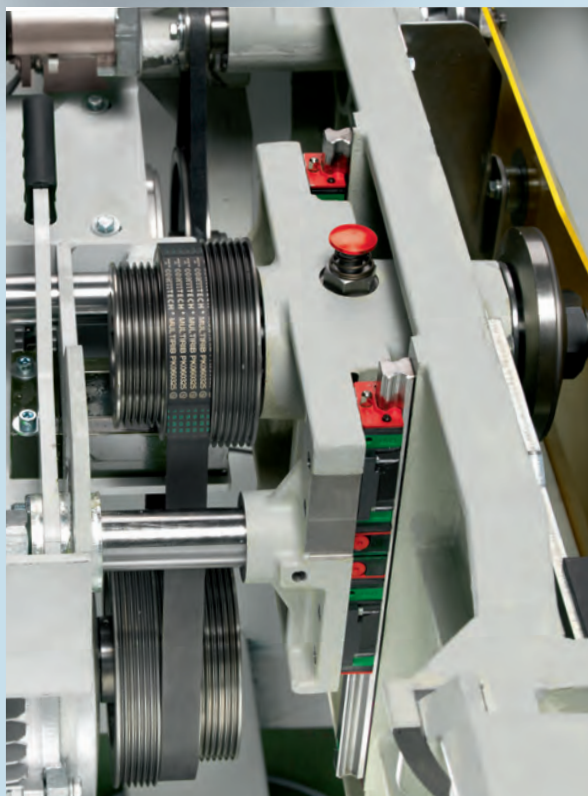
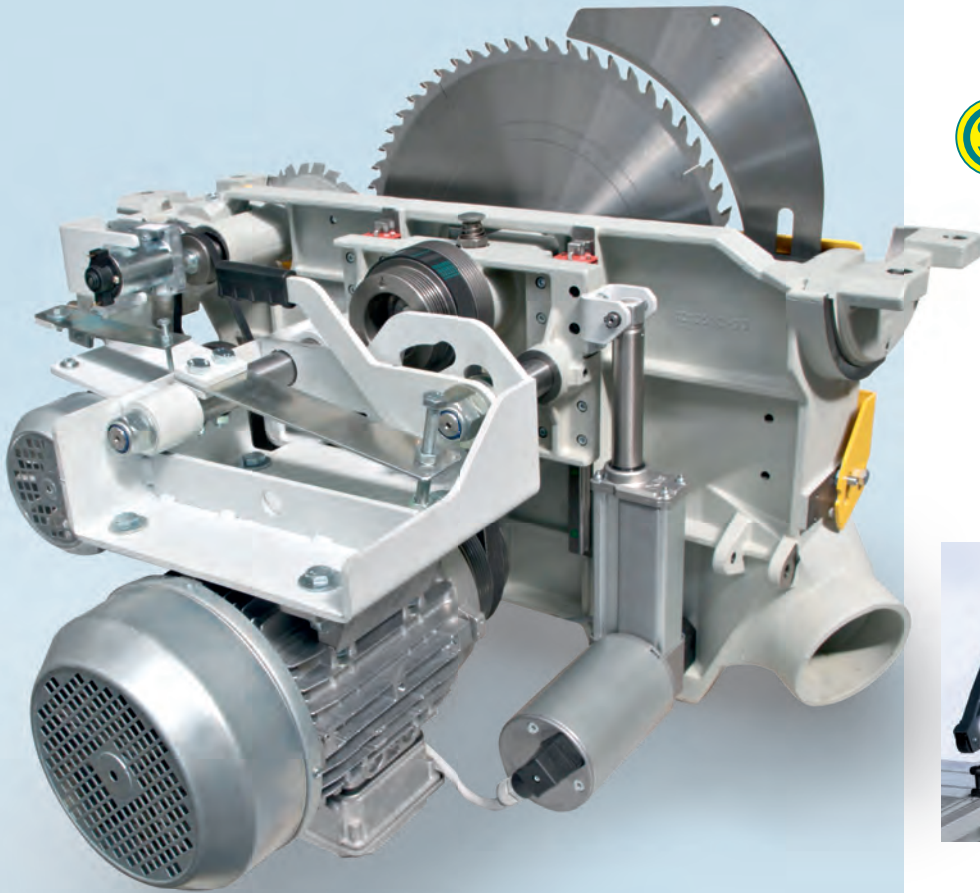

Cambio velocità manuale sul piano.
Changement de vitesse manuel sur la table.
Cambio de velocidad manual sobre la mesa.



Protezione BASIC
Protecteur BASIC
Protección BASIC



Scoring Unit UNICA 400

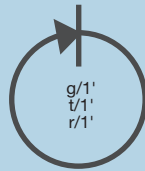

3000
4000
6000

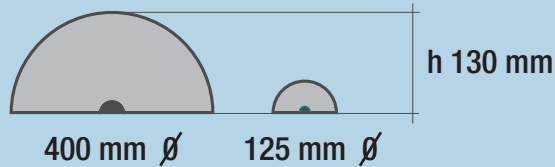

	mm	mm	mm	mm
Ø Lama (con incisore) Ø Lame (avec inciseur) Ø Disco (con incisor)	250	300	350	400
Altezza di taglio 90° Hauteur de coupe à 90° Altura de corte à 90°	55	80	105	130
Sporgenza lama dal piano di lavoro con lama completamente abbassata Saillie lame de la table d'usinage avec lame complètement baissée Salida disco de la mesa de trabajo con disco completamente bajado	0	0	0	25
Altezza di taglio 46° Hauteur de coupe à 46° Altura de corte à 46°	35	55	70	90
Spessore coltello divisore Épaisseur couteau diviseur Espesor cuchilla divisora	2,8	2,8	3	3

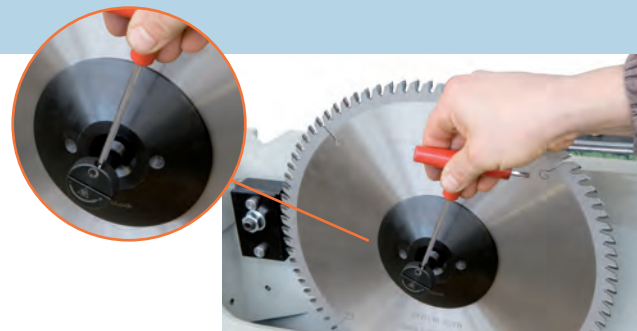

OPTION - PROLOCK-AKE
Bloccaggio rapido lama
Blocage rapide lame
Bloqueo rapido disco

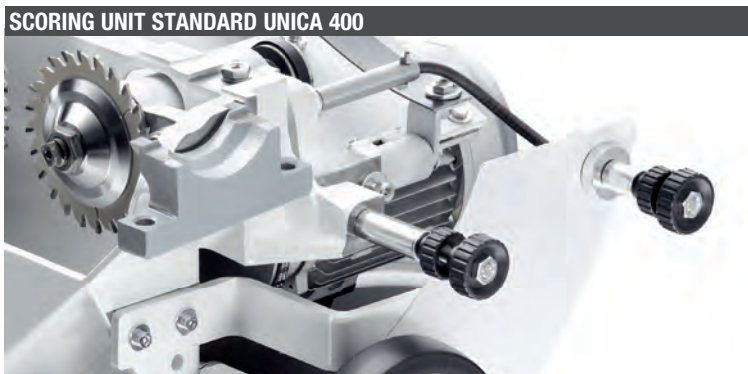

SCORING UNIT STANDARD UNICA 400 E - EVO - DIGIT

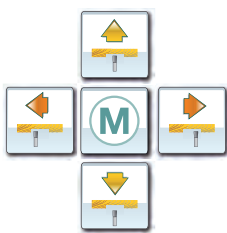

Gruppo incisore con regolazione elettrica e posizionamento verticale automatico ON OFF

Groupe inciseur avec réglage électrique et positionnement vertical automatique ON OFF

Grupo incisor con regulacion eléctrica y posicionamiento vertical automatico ON OFF

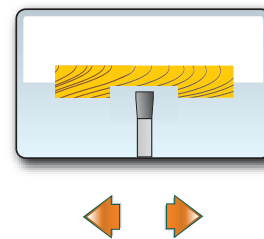

SCORING UNIT STANDARD UNICA 400 PROGRAM 3



Visualizzazione 2 assi su program 3
Affichage 2 axes sur program 3
Visualización 2 ejes en program 3

SCORING UNIT OPTION



CD - Lama incisore doppia a regolazione manuale da 2,8 a 3,6 mm a incisor fermo

CD - Lame inciseur double à réglage manuelle de 2,8 à 3,6 mm, inciseur arrêté

CD - Disco incisor doble regulable e manual de 2,8 a 3,6 mm a incisor parado

UNICA 400 / UNICA 400 E / UNICA 400 DIGIT 2

SEGHE CIRCOLARI SQUADRATRICI A LAMA INCLINABILE
 SCIES A FORMAT À LAME INCLINABLE
 ESCUADRADORAS CON DISCO INCLINABLE

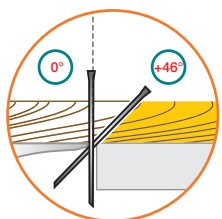

CE

UNICA 400

Standard:

- Sollevamento motorizzato della lama
- Movimento di inclinazione della lama tramite volantino.
- Visualizzatore gravitazionale dell'inclinazione lama
- Incisore manuale

Standard:

- *Montée motorisée de la lame*
- *Mouvement de la inclination de la lame par volant*
- *Afficheur gravitationnel de l'inclination de la lame*
- *Inciseur manuel*

Standard:

- Subida motorizada disco
- Inclinación del disco por volante.
- Visualizador gravitacional de la inclinación disco
- Incisor manual

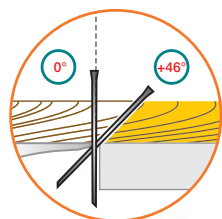

CE

UNICA 400 E

Option

Standard:

- Sollevamento motorizzato della lama
- Inclinazione motorizzata della lama con visualizzatore digitale elettronico LCD
- Incisore motorizzato

Equipement de série:

- *Montée motorisée de la lame*
- *Inclinaison motorisée de la lame avec afficheur digitale électronique LCD*
- *Inciseur motorisé*

Estandard:

- Subida motorizada disco
- Inclinación motorizada disco con visualizador digital electrónico LCD
- Incisor motorizado



Digit 2 Touch screen

Digit 2:

- Possibilità di memorizzare fino a 500 programmi di lavoro
- Posizionamento elettronico dell'altezza e dell'inclinazione della lama con correzione automatica dell'altezza in rapporto all'inclinazione.

Digit 2:

- *Possibilité de mémoriser jusqu'à 500 programmes de travail*
- *Positionneur électronique de la hauteur et de l'inclinaison de la lame avec correction automatique de la hauteur par rapport à l'inclinaison*

Digit 2:

- Posibilidad de memorizar hasta 500 programas de trabajo
- Posicionamiento electrónico altura y inclinación disco con corrección automática altura en relación a la inclinación

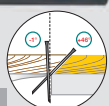

UNICA 400 DIGIT 2

UNICA 400 EVO



SEGHE CIRCOLARI SQUADRATRICI A LAMA INCLINABILE
 SCIES A FORMAT À LAME INCLINABLE
 ESCUADRADORAS CON DISCO INCLINABLE

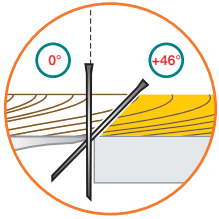

Option



UNICA 400 EVO



Guida parallela montata su guida lineare con pattini a ricircolo di sfere e trasmissione mediante vite trapezoidale e rettificata
Guide parallèle montée sur guide linéaire équipée de patins à recercle de billes et transmission par vis trapézoïdale et rectifiée
 Guía paralela puesta en guías lineares a patines a recirculo de bolas y transmisión por tornillo trapezoidal y rectificado

option



Visualizzatore digitale elettronico LCD sollevamento lama
Afficheur digitale électronique LCD monté de la lame
 Visualizador digital electrónico LCD subida disco



Standard:

- Sollevamento motorizzato della lama
- Inclinazione motorizzata della lama con visualizzatore digitale elettronico LCD
- Incisore motorizzato
- Scorrimento della guida lineare con pattini a ricircolo di sfere.
- Guida parallela motorizzata a 2 velocità con posizionamento decimale e visualizzazione digitale elettronico LCD

Equipement de série:

- *Montée motorisée de la lame*
- *Inclinaison motorisée de la lame avec afficheur digitale électronique LCD*
- *Inciseur motorisé*
- *Glissement du guide parallèle sur une barre trempée et rectifiée avec support glissement guide à recercle de billes*
- *Guide parallèle avec positionneur électronique avec afficheur digitale électronique LCD*

Estandard:

- Subida motorizada disco
- Inclinación motorizada disco con visualizador digital electrónico LCD
- Incisor motorizado
- Deslizamiento tope paralelo en barra templada y rectificada con soporte a recirculo de bolas
- Tope paralelo con posicionador electrónico con visualizador digital electrónico LCD

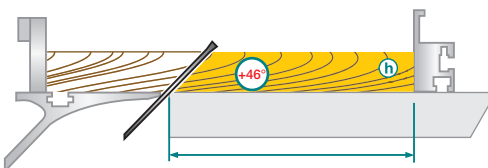

UNICA 400 DIGIT 1

SEGA CIRCOLARE SQUADRATRICE A LAMA INCLINABILE
 CON PROGRAMMATORE ELETTRONICO A 1 ASSE
*SCIE À FORMAT À LAME INCLINABLE
 AVEC PROGRAMMATEUR ÉLECTRONIQUE À 1 AXE*
 ESCUADRADORA A DISCO INCLINABLE
 CON PROGRAMATOR ELECTRONICO A 1 EJE

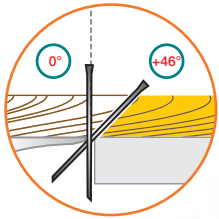

Guida parallela montata su guida lineare con pattini a ricircolo di sfere e trasmissione mediante vite a ricircolo di sfere
Guide parallèle monté sur guide linéaire équipée de patins à recercle de billes et transmission par vis à recercle de billes
 Guía paralela montada en guía lineal con patines a recirculo de bolas y transmisión por tornillos a recirculo de bolas

UNICA 400 DIGIT 1



DIGIT 1 - Touch screen

Digit 1:

- Possibilità di memorizzare fino a 500 programmi di lavoro
- Guida parallela con posizionatore elettronico e visualizzazione digitale dell'inclinazione lama con compensazione del posizionamento della guida con lama inclinata.
- Movimenti di sollevamento e dell'inclinazione della lama motorizzati.

Digit 1:

- Possibilité de mémoriser jusqu'à 500 programmes de travail.
- Guide parallèle avec positionneur électronique et afficheur digitale d'inclinaison de la lame avec compensation du positionnement du guide avec lame inclinée.
- Mouvements de montée et d'inclinaison de la lame motorisée.

Digit 1:

- Posibilidad de memorizar hasta 500 programas de trabajo
- Tope paralelo con posicionador electrónico y visualizador digital de la inclinación disco con compensación del posicionamiento del tope con disco inclinado.
- Movimientos de subida y inclinación disco motorizada.

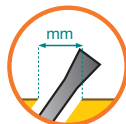
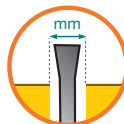
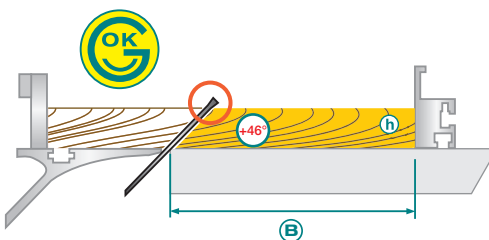

B) Guida parallela con posizionatore elettronico con compensazione del posizionamento con lama inclinata.

B) Guide parallèle avec positionneur électronique avec compensation du positionnement avec lame inclinée.

B) Tope paralelo con posicionador electrónico con compensación del posicionamiento con disco inclinado.

UNICA 400 DIGIT 3

SEGA CIRCOLARE SQUADRATRICE A LAMA INCLINABILE
 CON PROGRAMMATTORE ELETTRONICO A 3 ASSI
SCIE À FORMAT À LAME INCLINABLE AVEC PROGRAMMATEUR ÉLECTRONIQUE À 3 AXES
 ESCUADRADORA A DISCO INCLINABLE CON PROGRAMATOR ELECTRONICO A 3 EJES

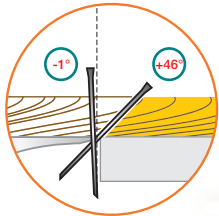

Option



Guida parallela montata su guida lineare con pattini a ricircolo di sfere e trasmissione mediante vite a ricircolo di sfere
Guide parallèle monté sur guide linéaire équipée de patins à recircule de billes et transmission par vis à recircule de billes
 Guía paralela montada en guía lineal con patines a recirculo de bolas y transmisión por tornillos a recirculo de bola

UNICA 400 DIGIT 3



DIGIT 3 - Touch screen

Digit 3:

- Possibilità di memorizzare fino a 500 programmi di lavoro
- Posizionamento elettronico dell'altezza e dell'inclinazione della lama con correzione automatica dell'altezza in rapporto all'inclinazione.
- Guida parallela con posizionatore elettronico e visualizzazione digitale dell'inclinazione lama con compensazione del posizionamento della guida con lama inclinata. Calcolo automatico della quota superiore ed inferiore del pannello da tagliare (A-B).

Digit 3:

- Possibilité de mémoriser jusqu'à 500 programmes de travail
- Positionneur électronique de la hauteur et de l'inclinaison de la lame avec correction automatique par rapport à l'inclinaison
- Guide parallèle avec positionneur électronique et afficheur digitale d'inclinaison de la lame avec compensation du positionnement du guide avec lame inclinée. Calcul automatique de la mesure supérieure et inférieure du panneau (A-B).

Digit 3:

- Posibilidad de memorizar hasta 500 programas de trabajo
- Posicionamiento electrónico altura y inclinación disco con corrección automática de la altura en relación a la inclinación
- Tope paralelo con posicionador electrónico y visualizador digital de la inclinación disco con compensación del posicionamiento del tope con disco inclinado. Cálculo automático de la medida superior y inferior de la pieza a cortar (A-B).

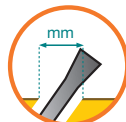
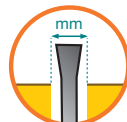
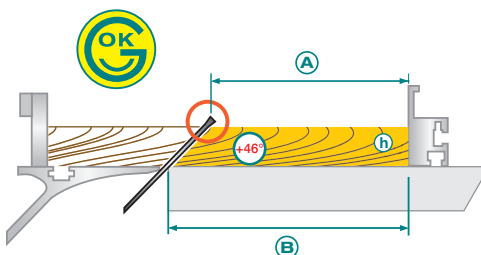

Guida parallela con posizionatore elettronico con compensazione del posizionamento con lama inclinata.

Guide parallèle avec positionneur électronique avec compensation du positionnement avec lame inclinée.

Tope paralelo con posicionador electrónico con compensación del posicionamiento con disco inclinado.

UNICA 400 PROGRAM 4

SQUADRATRICE A LAMA INCLINABILE CON PROGRAMMATORE ELETTRONICO 4 ASSI CONTROLLATI
 SCIE À FORMAT À LAME INCLINABLE AVEC PROGRAMMATEUR ÉLECTRONIQUE 4 AXES CONTRÔLÉS
 ESCUADRADORA A DISCO INCLINABLE CON PROGRAMADOR ELECTRÓNICO A 4 EJES CONTROLADOS



UNICA 400 PROGRAM 4



SIEMENS

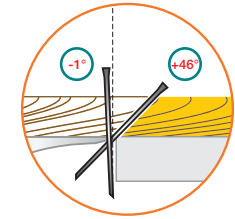

Guida parallela montata su guida lineare con pattini a ricircolo di sfere e trasmissione mediante vite a ricircolo di sfere
Guide parallèle montée sur guide linéaire équipée de patins à recircule de billes et transmission par vis à recircule de billes
 Guía paralela montada en guía lineal con patines a recirculo de bolas y transmisión por tornillos a recirculo de bola



Standard
 Touch screen
 SIEMENS SIMATIC 5,7"



Option
 Touch screen
 SIEMENS SIMATIC 10" MP 277



Option
 Touch screen
 SIEMENS SIMATIC 12" MICROBOX 420 XP PROFESSIONAL

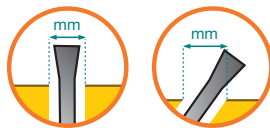
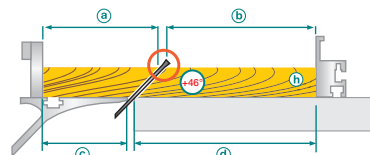

Funzione di calcolo per il taglio di un pannello inclinato utilizzando il carro squadratore. Il computer calcola anche le misure del pannello con la lama inclinata / *Fonction de calcul pour la coupe d'un panneau incliné en utilisant le chariot équeriseur. Le moniteur calcule aussi les mesures du panneau avec la lame inclinée*
 Función de cálculo para el corte de un panel inclinado con el carro escuadrador. El ordenador calcula también las medidas del panel con disco inclinado

Program 4:

Programmatore elettronico 4 assi controllati completo di:

- Programmatore elettronico TOUCH SCREEN a colori
- Programmazione della posizione guida parallela con compensazione automatica della quota con la lama inclinata.
- Calcolo automatico della quota superiore e inferiore del pannello da tagliare (b-d)
- Programmazione della posizione della battuta sulla guida estensibile del carro squadratore.
- Calcolo automatico della quota superiore e inferiore del pannello da tagliare (a-c)
- Programmazione del sollevamento della lama con compensazione dell'altezza in rapporto allo spessore del pannello da tagliare e all'inclinazione della lama
- Possibilità di memorizzare fino a 650 programmi di lavoro su 3 assi

Program 4:

Programmateur électronique 4 axes contrôlés complet de:

- Ordinateur électronique TOUCH SCREEN à couleur
- Programmation de la position du guide parallèle avec compensation automatique de la mesure avec la lame inclinée
- Calcul automatique de la cote supérieure et inférieure du panneau à couper (b-d)
- Programmation de la position de la butte sur le guide extensible du chariot
- Calcul automatique de la cote supérieure et inférieure du panneau à couper (a-c)
- Programmation de la montée lame en fonction de l'épaisseur du panneau à couper et de l'inclinaison de la lame
- Possibilité de mémoriser jusqu'à 650 programmes de travail sur 3 axes

Program 4:

Programador electrónico a 4 ejes controlados completo de:

- Programador electrónico TOUCH SCREEN a colores.
- Programación de la posición del tope paralelo con compensación automática de la medida con disco inclinado
- Cálculo automático de la cota superior e inferior del panel a cortar (b-d)
- Programación de la posición del tope en la guía extensible del carro escuadrador
- Cálculo automático de la cota superior e inferior del panel a cortar (a-c)
- Programación de la subida del disco con compensación de la altura en relación del espesor de la pieza a cortar y de la inclinación del disco
- Posibilidad de memorizar hasta 650 programas de trabajo en los 3 ejes



4° ASSE A 2-3 BATTUTE PROGRAMMATE
4ème AXE A 2-3 BUTTEES PROGRAMMEES
4° EJE A 2-3 TOPES PROGRAMADAS

B1) Battuta motorizzata della guida carro squadratore, montata su guida lineare con pattini a ricircolo di sfere e trasmissione mediante vite a ricircolo di sfere. Si posiziona da 160 mm a 1700 mm.

Per mezzo di un magnete posiziona le battute B2 e B3 PATENTED (optional).

Buttée motorisée du guide du chariot, montée sur un guide linéaire équipée de patins à recercle de billes et transmission par vis à recercle de billes. Elle se positionne de 160 mm à 1700 mm.

Par un magnéto, elle positionne les butteés B2 et B3 PATENTED (optionnel).

Tope motorizada de la guía carro escuadrador, puesta en la guía lineal con patines a ricircolo de bolas y transmisión por tornillo a ricircolo de bolas. Se pone de 160 mm a 1700 mm.

Con un magneto posicona los topes B2 y B3 PATENTED (a pedido)

B2) 2° Battuta sull'estensione, montata su guida lineare con pattini a ricircolo di sfere si posiziona da mm 1900 a mm 3200.

2ème buttée sur l'extension, montée sur le guide linéaire équipée de patins à recercle de billes se positionne de mm 1900 à mm 3200.

2° tope en la extension, puesta en guía lineal a patines a ricircolo de bolas se pone de mm 1900 a mm 3200

B3) 2° Battuta si posiziona da mm 300 a mm 1900 (optional)

2ème buttée qui se positionne de mm 300 à mm 1900 (optionnel)

2° tope se pone de mm 300 a mm 1900 (a pedido)

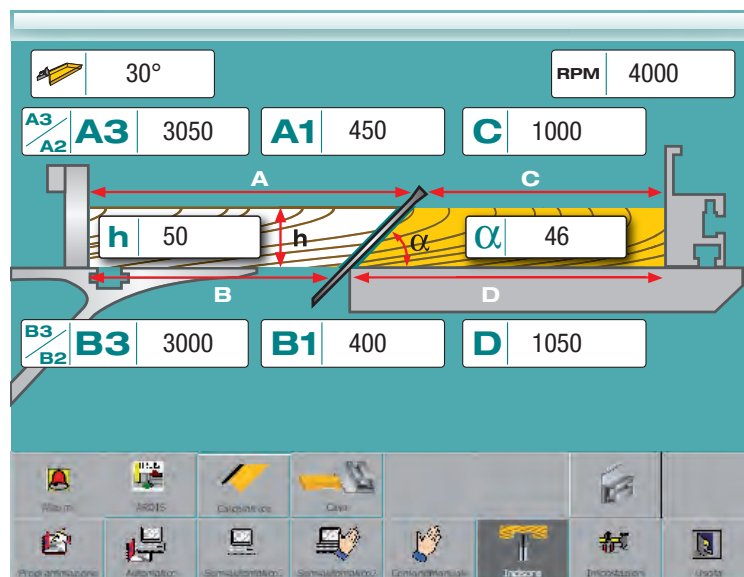

PROGRAM 4

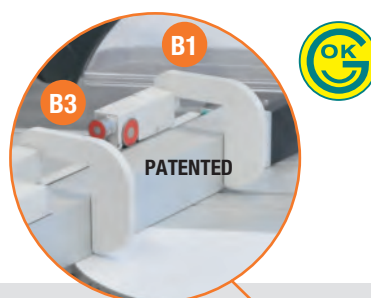

CARRO FISSO 0° +45° CON GUIDA INCLINABILE
CHARIOT FIXE 0°+45° AVEC GUIDE INCLINÉ
CARRO FIJO 0° +45° CON GUIA INCLINADA

La Guida estensibile sul carro fisso si può montare solo sul lato sinistro del carro e la misura delle battute si compensa automaticamente quando la guida viene inclinata.

Le guide extensible sur le chariot fixe peut être monté seulement sur le coté gauche du chariot et la mesure des butteés se compense automatiquement quand le guide est incliné.

La guía extensible en el carro fijo se puede montar solo en el lado izquierdo del carro y la medida de los topes se equilibra automáticamente cuando la guía es inclinada.

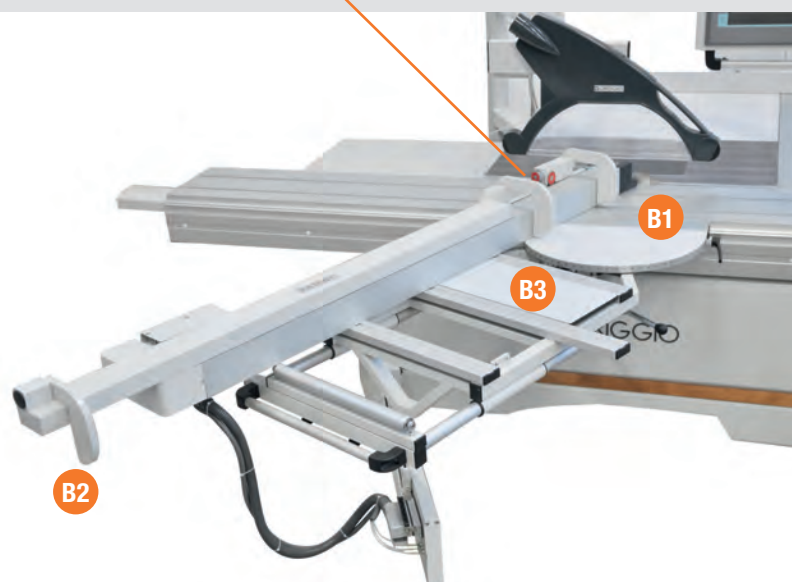

CARRO INCLINABILE +47° -47°
CHARIOT INCLINABLE +47° -47°
CARRO ESCUADRADOR INCLINABLE +47° -47°

Il carro squadratore inclinabile +47° -47° compensa automaticamente la misura delle battute quando viene inclinato.

Le chariot inclinable +47° -47° compense automatiquement la mesure des butteés quand il est incliné.

El carro escuadrador inclinable +47°-47° equilibra automáticamente la medida de los topes cuando es inclinado

UNICA 400 PROGRAM 3

SQUADRATRICE A LAMA INCLINABILE CON PROGRAMMATORE ELETTRONICO 3 ASSI CONTROLLATI
 SCIE À FORMAT À LAME INCLINABLE AVEC PROGRAMMATEUR ÉLECTRONIQUE 3 AXES CONTRÔLÉS
 ESCUADRADORA A DISCO INCLINABLE CON PROGRAMADOR ELECTRÓNICO A 3 EJES CONTROLADOS



UNICA 400 PROGRAM 3



Guida parallela montata su guida lineare con pattini a ricircolo di sfere e trasmissione mediante vite a ricircolo di sfere.
Guide parallèle montée sur guide linéaire équipée de patins à recircule de billes et transmission par vis à recircule de billes
 Guía paralela montada en guía lineal con patines a recirculo de bolas y transmisión por tornillos a recirculo de bolas

SIEMENS



Standard
 Touch screen
 SIEMENS SIMATIC 5,7"



Option
 Touch screen
 SIEMENS SIMATIC 10" MP 277



Option
 Touch screen
 SIEMENS SIMATIC 12" MICROBOX 420 XP PROFESSIONAL

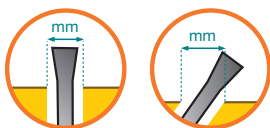
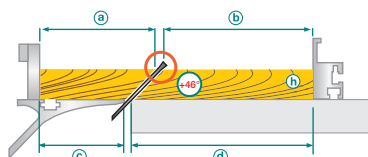

Funzione di calcolo per il taglio di un pannello inclinato utilizzando il carro squadratore. Il computer calcola anche le misure del pannello con la lama inclinata / *Fonction de calcul pour la coupe d'un panneau incliné en utilisant le chariot équerisseur. Le moniteur calcule aussi les mesures du panneau avec la lame inclinée* / Funcion de calculo para el corte de un panel inclinado con el carro escuadrador. El ordenador calcula también las medidas del panel con disco inclinado

Program 3:

Programmatore elettronico 3 assi controllati completo di:

- Programmatore elettronico TOUCH SCREEN a colori
- Programmazione della posizione guida parallela con compensazione automatica della quota con la lama inclinata.
- Calcolo automatico della quota superiore e inferiore del pannello da tagliare (b - d)
- Calcolo automatico della quota di posizionamento della battuta sulla guida estensibile del carro squadratore: si ottiene la quota superiore e inferiore del pannello da tagliare e la compensazione della quota con la lama inclinata (a-c)
- Programmazione del sollevamento della lama con compensazione dell'altezza in rapporto allo spessore del pannello da tagliare e all'inclinazione della lama
- Possibilità di memorizzare fino a 650 programmi di lavoro su 3 assi

Program 3:

Programmateur électronique 3 axes contrôlés complet de:

- Ordinateur électronique TOUCH SCREEN à couleur
- Programmation de la position du guide parallèle avec compensation automatique de la mesure avec la lame inclinée
- Calcul automatique de la cote supérieure et inférieure du panneau à couper (b-d)
- Calcul automatique de la cote de positionnement de la butée sur le guide du chariot équerisseur: on obtient la cote supérieure et inférieure du panneau à couper compensation de la cote avec la lame inclinée (a-c)
- Programmation de la montée lame en fonction de l'épaisseur du panneau à couper et de l'inclinaison de la lame
- Possibilité de mémoriser jusqu'à 650 programmes de travail sur 3 axes

Program 3:

Programador electrónico a 3 ejes controlados completo de:

- Programador electrónico TOUCH SCREEN a colores.
- Programación de la posición del tope paralelo con compensación automática de la medida con disco inclinado
- Cálculo automático de la cota superior e inferior de panel a cortar (b - d)
- Cálculo automático de la cota de posicionamiento del tope en la guía extensible del carro escuadrador: se consigue la cota superior e inferior del panel a cortar y la compensación automática de la cota con el disco inclinado (a-c)
- Programación de la subida del disco con compensación de la altura en relación del espesor de la pieza a cortar y de la inclinación del disco
- Posibilidad de memorizar hasta 650 programas de trabajo en los 3 ejes



UNICA 500

Gruppo lama
inclinabile,
completamente
in ghisa.
Sollevamento lama
su guide lineari e
pattini a ricircolo di
sfere

*Groupe scie
inclinable
complètement
en fonte. Montee de
la lame sur guide
lineaire et patins a
recirculation
de billes*

Grupo sierra
inclinable,
completamente
en fundación. Subida
disco en guías
lineares y guía a
recirculo de bolas

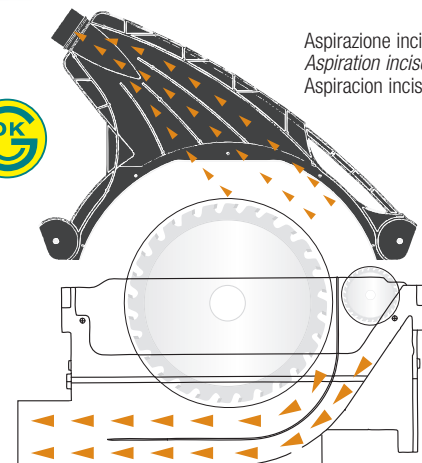
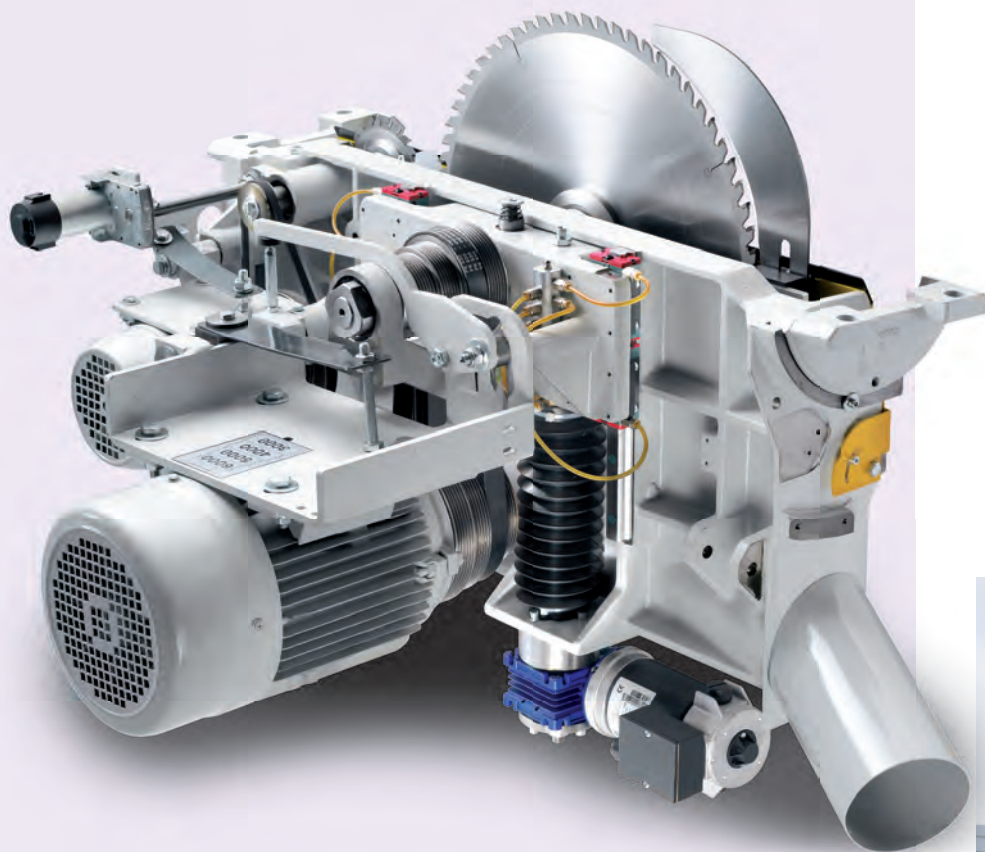

Aspirazione incisore
Aspiration inciseur
Aspiracion incisor

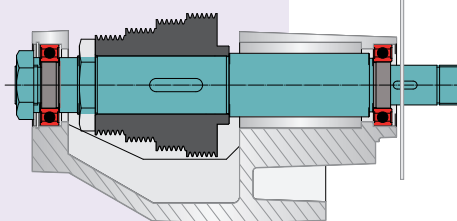
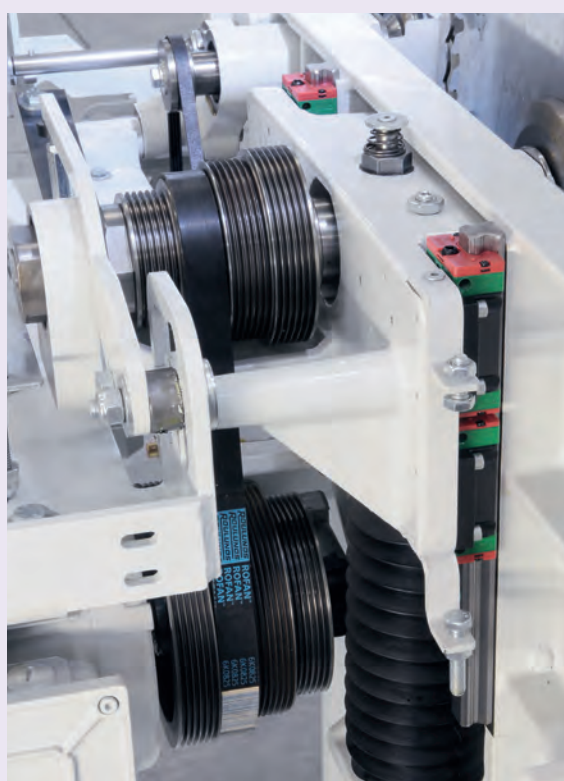

Cambio velocità manuale sul piano.
Changement de vitesse manuel sur la table.
Cambio de velocidad manual sobre la mesa.



Protezione BASIC
Protecteur BASIC
Protección BASIC



Scoring Unit UNICA 500



Ø 550 mm

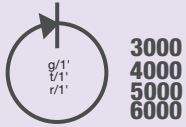

3000
4000
5000
6000

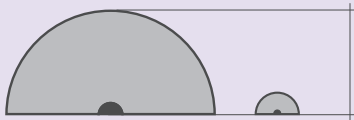

Standard 450 mm Ø 125 mm Ø
Option 550 mm Ø -

	mm	mm	mm	mm	mm	mm
Ø Lama (con incisore) Ø Lame (avec inciseur) Ø Disco (con incisor)	250	300	350	400	450	550 (Option) senza lama incisore montata / sans lame inciseur montée / sin disco incisor montado
Altezza di taglio 90° Hauteur de coupe à 90° Altura de corte à 90°	55	80	105	130	155	203
Sporgenza lama dal piano di lavoro con lama completamente abbassata Saillie lame de la table d'usinage avec lame complètement baissée Salida disco de la mesa de trabajo con disco completamente bajado	0	0	0	25	50	203
Altezza di taglio 46° Hauteur de coupe à 46° Altura de corte à 46°	35	55	70	90	115	150
Spessore coltello divisore Épaisseur couteau diviseur Espesor cuchilla divisora	2,8	2,8	3	3	3	3,2

(450) 155 mm h
(550) 203 mm h



SCORING UNIT STANDARD - UNICA 500 E - EVO - DIGIT 1

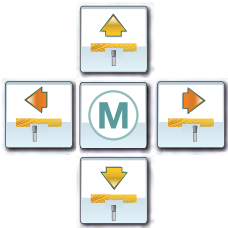

Gruppo incisore con regolazione elettrica e posizionamento verticale automatico ON OFF

Groupe inciseur avec réglage électrique et positionnement vertical automatique ON OFF

Grupo incisor con regulacion electrica y posicionamiento vertical automatico ON OFF

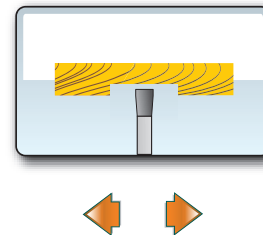

OPTION - PROLOCK-AKE
Bloccaggio rapido lama
Blocage rapide lame
Bloqueo rapido disco

SCORING UNIT STANDARD - PROGRAM



Visualizzazione 2 assi su Program
Affichage 2 axes sur Program
Visualización 2 ejes en Program

SCORING UNIT OPTION

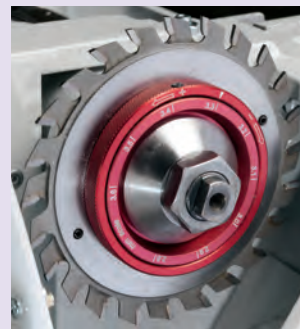

CD - Lama incisore doppia a regolazione manuale da 2,8 a 3,6 mm a incisor fermo

CD - Lame inciseur double à réglage manuel de 2,8 à 3,6 mm, inciseur arrêté

CD - Disco incisor doble regulable e manual de 2,8 a 3,6 mm a incisor parado

SCORING UNIT OPTION 2-3 AXES PROGRAM



Programmazione 2 o 3 assi su Program
Lama incisore doppia visualizzata e regolabile elettricamente da 2,8 a 3,8 mm con motore in funzione

Programmation 2 ou 3 axes sur Program
Lame inciseur double à réglage électrique de 2,8 à 3,8 mm, affichage lorsque le moteur est en fonction

Programacion 2 o 3 ejes en Program
Disco incisor doble visualizado y regulable electronicamente de 2,8 a 3,8 mm con motor en funcion

UNICA 500 / UNICA 500 E / UNICA 500 DIGIT 2

SEGHE CIRCOLARI SQUADRATRICI A LAMA INCLINABILE
 SCIES A FORMAT À LAME INCLINABLE
 ESCUADRADORAS CON DISCO INCLINABLE

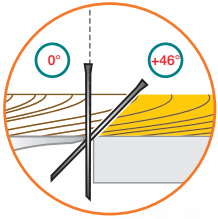

UNICA 500



Standard:

- Sollevamento motorizzato della lama
- Movimento di inclinazione della lama tramite volantino.
- Visualizzatore gravitazionale dell'inclinazione lama.

Standard:

- *Montée motorisée de la lame*
- *Mouvement de la inclination de la lame par volants*
- *Afficheur gravitationnel de l'inclination de la lame*

Standard:

- Subida motorizada disco
- *Inclinacion del disco por volante.*
- Visualizador gravitacional de la inclinacion disco



OPTION

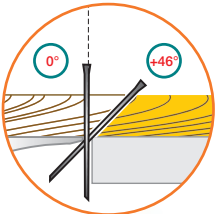

UNICA 500 E



Standard:

- Sollevamento motorizzato della lama con visualizzatore digitale elettronico.
- Inclinazione motorizzata della lama con visualizzatore digitale elettronico LCD

Equipement de série:

- *Montée motorisée de la lame avec afficheur digitale électronique LCD.*
- *Inclinaison motorisée de la lame avec afficheur digitale électronique LCD*

Estandard:

- Subida motorizada disco con visualizador digital electrónico LCD
- Inclinación motorizada disco con visualizador digital electrónico LCD



Digit 2 Touch screen

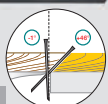

Digit 2:

- Possibilità di memorizzare fino a 500 programmi di lavoro
- Posizionamento elettronico dell'altezza e dell'inclinazione della lama con correzione automatica dell'altezza in rapporto all'inclinazione.

Digit 2:

- *Possibilità de mémoriser jusqu'à 500 programmes de travail*
- *Positionneur électronique de la hauteur et de l'inclinaison de la lame avec correction automatique de la hauteur par rapport à l'inclinaison*

Digit 2:

- Posibilidad de memorizar hasta 500 programas de trabajo
- Posicionamiento electrónico altura y inclinación disco con corrección automática altura en relación a la inclinación

UNICA 500 DIGIT 2

UNICA 500 EVO



SEGHE CIRCOLARI SQUADRATRICI A LAMA INCLINABILE
SCIES A FORMAT À LAME INCLINABLE
 ESCUADRADORAS CON DISCO INCLINABLE

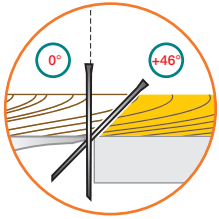

Option



CE

UNICA 500 EVO



Guida parallela montata su guida lineare con pattini a ricircolo di sfere e trasmissione mediante vite trapezoidale e rettificata
Guide parallèle montée sur guide linéaire équipée de patins à recircule de billes et transmission par vis trapézoïdale et rectifiée
 Guía paralela puesta en guías lineares a patines a recirculo de bolas y transmisión por tornillo trapezoidal y rectificadado

option



Visualizzatore digitale elettronico LCD sollevamento lama
Afficheur digitale électronique LCD monté de la lame
 Visualizador digital electrónico LCD subida disco



Standard:

- Sollevamento motorizzato della lama
- Inclinazione motorizzata della lama con visualizzatore digitale elettronico LCD
- Scorrimento della guida lineare con pattini a ricircolo di sfere.
- Guida parallela motorizzata a 2 velocità con posizionamento decimale e visualizzazione digitale elettronico LCD

Equipement de série:

- *Montée motorisée de la lame*
- *Inclinaison motorisée de la lame avec afficheur digitale électronique LCD*
- *Glissement du guide parallèle sur une barre trempée et rectifiée avec support glissement guide à recircule de billes*
- *Guide parallèle avec positionneur électronique avec afficheur digitale électronique LCD*

Estandard:

- Subida motorizada disco
- Inclinación motorizada disco con visualizador digital electrónico LCD
- Deslizamiento tope paralelo en barra templada y rectificada con soporte a recirculo de bolas
- Tope paralelo con posicionador electrónico con visualizador digital electrónico LCD

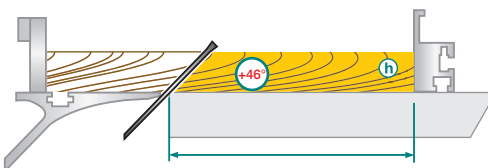



UNICA 500 DIGIT 3

SEGA CIRCOLARE SQUADRATRICE A LAMA INCLINABILE CON PROGRAMMATTORE ELETTRONICO A 3 ASSI
 SCIE À FORMAT À LAME INCLINABLE AVEC PROGRAMMATEUR ÉLECTRONIQUE À 3 AXES
 ESCUADRADORA A DISCO INCLINABLE CON PROGRAMATOR ELECTRONICO A 3 EJES

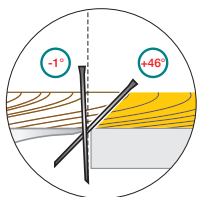

OPTION



UNICA 500 DIGIT 3



Guida parallela montata su guida lineare con pattini a ricircolo di sfere e trasmissione mediante vite a ricircolo di sfere
Guide parallèle montée sur guide linéaire équipée de patins à recircule de billes et transmission par vis à recircule de billes
 Guía paralela montada en guía lineal con patines a recirculo de bolas y transmisión por tornillos a recirculo de bolas



Touch screen - Digit 3

Digit 3:

- Possibilità di memorizzare fino a 500 programmi di lavoro
- Posizionamento elettronico dell'altezza e dell'inclinazione della lama con correzione automatica dell'altezza in rapporto all'inclinazione.
- Guida parallela con posizionatore elettronico e visualizzazione digitale dell'inclinazione lama con compensazione del posizionamento della guida con lama inclinata. Calcolo automatico della quota superiore ed inferiore del pannello da tagliare (A-B).

Digit 3:

- Possibilité de mémoriser jusqu'à 500 programmes de travail
- Positionneur électronique de la hauteur et de l'inclinaison de la lame avec correction automatique par rapport à l'inclinaison
- Guide parallèle avec positionneur électronique et afficheur digitale d'inclinaison de la lame avec compensation du positionnement du guide avec lame inclinée. Calcul automatique de la mesure supérieure et inférieure du panneau (A-B).

Digit 3:

- Posibilidad de memorizar hasta 500 programas de trabajo
- Posicionamiento electrónico altura y inclinación disco con corrección automática de la altura en relación a la inclinación de la altura en relación a la inclinación
- Tope paralelo con posicionador electrónico y visualizador digital de la inclinación disco con compensación del posicionamiento del tope con disco inclinado. Calculo automático de la medida superior y inferior de la pieza a cortar (A-B).

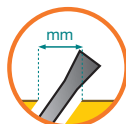
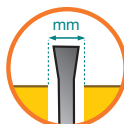
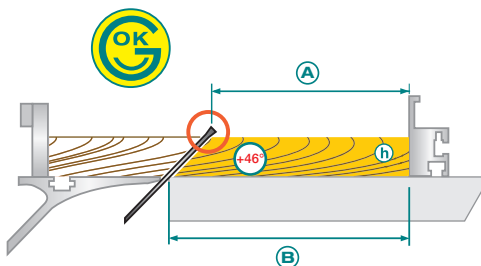

Guida parallela con posizionatore elettronico con compensazione del posizionamento con lama inclinata. Calcolo automatico della quota superiore (A) ed inferiore (B) del pannello da tagliare.

Guide parallèle avec positionneur électronique avec compensation du positionnement avec lame inclinée. Calcul automatique de la mesure supérieure (A) et inférieure (B) du panneau.

Tope paralelo con posicionador electrónico con compensación del posicionamiento con disco inclinado. Calculo automático de la medida superior (A) y inferior (B) de la pieza a cortar.

UNICA 500 PROGRAM 3

SQUADRATRICE A LAMA INCLINABILE CON PROGRAMMATORE ELETTRONICO 3 ASSI CONTROLLATI
 SCIE À FORMAT À LAME INCLINABLE AVEC PROGRAMMATEUR ÉLECTRONIQUE 3 AXES CONTRÔLÉS
 ESCUADRADORA A DISCO INCLINABLE CON PROGRAMADOR ELECTRÓNICO A 3 EJES CONTROLADOS

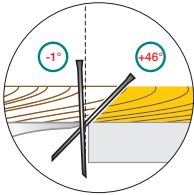

Guida parallela montata su guida lineare con pattini a ricircolo di sfere e trasmissione mediante vite a ricircolo di sfere
Guide parallèle montée sur guide linéaire équipée de patins à recircule de billes et transmission par vis à recircule de billes
 Guía paralela montada en guía lineal con patines a recirculo de bolas y transmisión por tornillos a recirculo de bolas

UNICA 500 PROGRAM 3



Standard
 Touch screen
 SIEMENS SIMATIC 5,7"



Option
 Touch screen
 SIEMENS SIMATIC 10" MP 277



Option
 Touch screen
 SIEMENS SIMATIC 12" MICROBOX 420 XP PROFESSIONAL

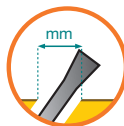
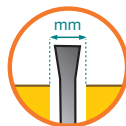
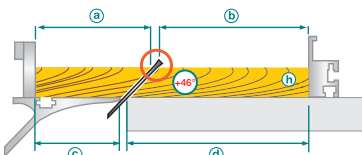

Funzione di calcolo per il taglio di un pannello inclinato utilizzando il carro squadatore. Il computer calcola anche le misure del pannello con la lama inclinata / *Fonction de calcul pour la coupe d'un panneau incliné en utilisant le chariot équarrisser. Le moniteur calcule aussi les mesures du panneau avec la lame inclinée*
 Funcion de calculo para el corte de un panel inclinado con el carro escuadrador. El ordenador calcula tambien las medidas del panel con disco inclinado

Program 3:

Programmatore elettronico 3 assi controllati completo di:

- Programmatore elettronico TOUCH SCREEN a colori
- Programmazione della posizione guida parallela con compensazione automatica della quota con la lama inclinata.
- Calcolo automatico della quota superiore e inferiore del pannello da tagliare (b-d)
- Calcolo automatico della quota di posizionamento della battuta sulla guida estensibile del carro squadatore: si ottiene la quota superiore e inferiore del pannello da tagliare e la compensazione della quota con la lama inclinata (a-c)
- Programmazione del sollevamento della lama con compensazione dell'altezza in rapporto allo spessore del pannello da tagliare e all'inclinazione della lama
- Possibilità di memorizzare fino a 650 programmi di lavoro su 3 assi

Program 3:

Programmeur électronique 3 axes contrôlés complet de:

- Ordinateur électronique TOUCH SCREEN à couleur
- Programmation de la position du guide parallèle avec compensation automatique de la mesure avec la lame inclinée
- Calcul automatique de la mesure supérieure et inférieure du panneau (b-d)
- Calcul automatique de la cote de positionnement de la butée sur le guide du chariot équarrisser: on obtient la cote supérieure et inférieure du panneau à couper compensation de la cote avec la lame inclinée
- Programmation de la position du guide parallèle avec compensation automatique de la mesure avec la lame inclinée (a-c)
- Programmation de la montée lame en fonction de l'épaisseur du panneau à couper et de l'inclinaison de la lame
- Possibilité de mémoriser jusqu'à 650 programmes de travail sur 3 axes

Program 3:

Programador electrónico a 3 ejes controlados completo de:

- Programador electrónico TOUCH SCREEN a colori
- Programación de la posición del tope paralelo con compensación automática de la medida con disco inclinado
- Cálculo automático de la cota superior e inferior de panel a cortar (b-d)
- Cálculo automático de la cota de posicionamiento del tope en la guía extensible del carro escuadrador: se consigue la cota superior e inferior del panel a cortar y la compensación automática de la cota con el disco inclinado (a-c)
- Programación de la subida del disco con compensación de la altura en relación del espesor de la pieza a cortar y de la inclinación del disco
- Posibilidad de memorizar hasta 650 programas de trabajo en los 3 ejes

UNICA 500 PROGRAM 4

SQUADRATRICE A LAMA INCLINABILE CON PROGRAMMATORE ELETTRONICO 4 ASSI CONTROLLATI
 SCIE À FORMAT À LAME INCLINABLE AVEC PROGRAMMATEUR ÉLECTRONIQUE 4 AXES CONTRÔLÉS
 ESCUADRADORA A DISCO INCLINABLE CON PROGRAMADOR ELECTRÓNICO A 4 EJES CONTROLADOS

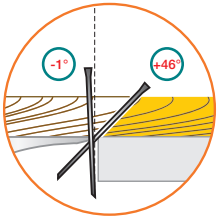

UNICA 400 PROGRAM 4



SIEMENS



Guida parallela montata su guida lineare con pattini a ricircolo di sfere e trasmissione mediante vite a ricircolo di sfere
Guide parallèle montée sur guide linéaire équipée de patins à recirculation de billes et transmission par vis à recirculation de billes
 Guía paralela montada en guía lineal con patines a recirculo de bolas y transmisión por tornillos a recirculo de bolas



Standard
 Touch screen
 SIEMENS SIMATIC 5,7"



Option
 Touch screen
 SIEMENS SIMATIC 10" MP 277



Option
 Touch screen
 SIEMENS SIMATIC 12" MICROBOX 420 XP PROFESSIONAL

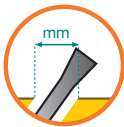
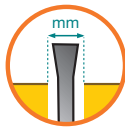
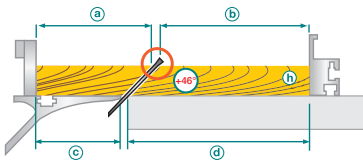

Funzione di calcolo per il taglio di un pannello inclinato utilizzando il carro squadratore. Il computer calcola anche le misure del pannello con la lama inclinata / *Fonction de calcul pour la coupe d'un panneau incliné en utilisant le chariot équerisseur. Le moniteur calcule aussi les mesures du panneau avec la lame inclinée*
 Función de cálculo para el corte de un panel inclinado con el carro escuadrador. El ordenador calcula también las medidas del panel con disco inclinado

Program 4:

Programmatore elettronico 4 assi controllati completo di:

- Programmatore elettronico TOUCH SCREEN a colori
- Programmazione della posizione guida parallela con compensazione automatica della quota con la lama inclinata.
- Calcolo automatico della quota superiore e inferiore del pannello da tagliare (b-d)
- Programmazione della posizione della battuta sulla guida estensibile del carro squadratore. Calcolo automatico della quota superiore e inferiore del pannello da tagliare (a-c)
- Programmazione del sollevamento della lama con compensazione dell'altezza in rapporto allo spessore del pannello da tagliare e all'inclinazione della lama
- Possibilità di memorizzare fino a 650 programmi di lavoro su 3 assi

Program 4:

Programmateur électronique 4 axes contrôlés complet de:

- Ordinateur électronique TOUCH SCREEN à couleur
- Programmation de la position du guide parallèle avec compensation automatique de la mesure avec la lame inclinée
- Calcul automatique de la cote supérieure et inférieure du panneau à couper (b-d)
- Calcul automatique de la cote de positionnement de la butée sur le guide du chariot équerisseur: on obtient la cote supérieure et inférieure du panneau à couper compensation de la cote avec la lame inclinée (a-c)
- Programmation de la montée lame en fonction de l'épaisseur du panneau à couper et de l'inclinaison de la lame
- Possibilité de mémoriser jusqu'à 650 programmes de travail sur 3 axes

Program 4:

Programador electrónico a 4 ejes controlados completo de:

- Programador electrónico TOUCH SCREEN a colori.
- Programación de la posición del tope paralelo con compensación automática de la medida con disco inclinado
- Cálculo automático de la cota superior e inferior de panel a cortar (b-d)
- Programación de la posición del tope en la guía extensible del carro escuadrador. Cálculo automático de la cota superior e inferior de panel a cortare (a-c)
- Programación de la subida del disco con compensación de la altura en relación del espesor de la pieza a cortar y de la inclinación del disco
- Posibilidad de memorizar hasta 650 programas de trabajo en los 3 ejes



4° ASSE A 2-3 BATTUTE PROGRAMMATE
4ème AXE A 2-3 BUTTEES PROGRAMMEES
4° EJE A 2-3 TOPES PROGRAMADAS

B1) Battuta motorizzata della guida carro squadratore, montata su guida lineare con pattini a ricircolo di sfere e trasmissione mediante vite a ricircolo di sfere. Si posiziona da 160 mm a 1700 mm.

Per mezzo di un magnete posiziona le battute B2 e B3 PATENTED (optional).

Buttée motorisée du guide du chariot, montée sur un guide linéaire équipée de patins à recercle de billes et transmission par vis à recercle de billes. Elle se positionne de 160 mm à 1700 mm.

Par un magnéto, elle positionne les butteés B2 et B3 PATENTED (optionnel).

Tope motorizada de la guía carro escuadrador, puesta en la guía lineal con patines a ricirculo de bolas y transmision por tornillo a ricirculo de bolas. Se pone de 160 mm a 1700 mm.

Con un magneto posiziona los topes B2 y B3 PATENTED (a pedido)

B2) 2° Battuta sull'estensione, montata su guida lineare con pattini a ricircolo di sfere si posiziona da mm 1900 a mm 3200.

2ème buttée sur l'extension, montée sur le guide linéaire équipée de patins à recercle de billes se positionne de mm 1900 à mm 3200.

2° tope en la extension, puesta en guía lineal a patines a recirculo de bolas se pone de mm 1900 a mm 3200

B3) 2° Battuta si posiziona da mm 300 a mm 1900 (optional)
 2ème buttée qui se positionne de mm 300 à mm 1900 (optionnel)
 2° tope se pone de mm 300 a mm 1900 (a pedido)

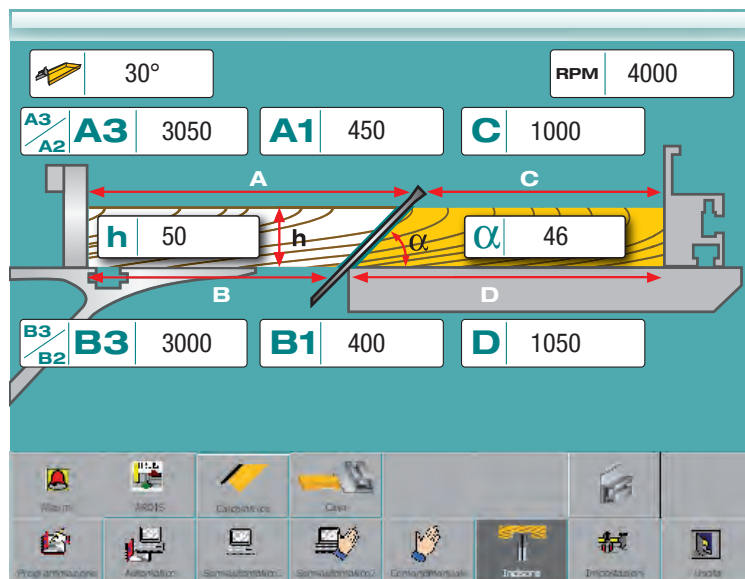

PROGRAM 4

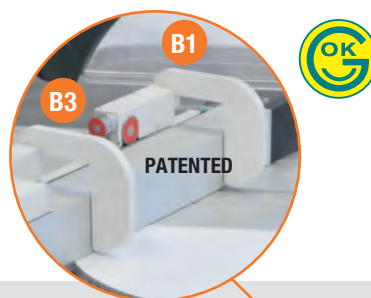

CARRO FISSO 0° +45° CON GUIDA INCLINABILE
CHARIOT FIXE 0°+45° AVEC GUIDE INCLINÉ
CARRO FIJO 0° +45° CON GUIA INCLINADA

La Guida estensibile sul carro fisso si può montare solo sul lato sinistro del carro e la misura delle battute si compensa automaticamente quando la guida viene inclinata.
Le guide extensible sur le chariot fixe peut être monté seulement sur le côté gauche du chariot et la mesure des butteés se compense automatiquement quand le guide est incliné.
 La guía extensible en el carro fijo se puede montar solo en el lado izquierdo del carro y la medida de los topes se equilibra automáticamente cuando la guía es inclinada.

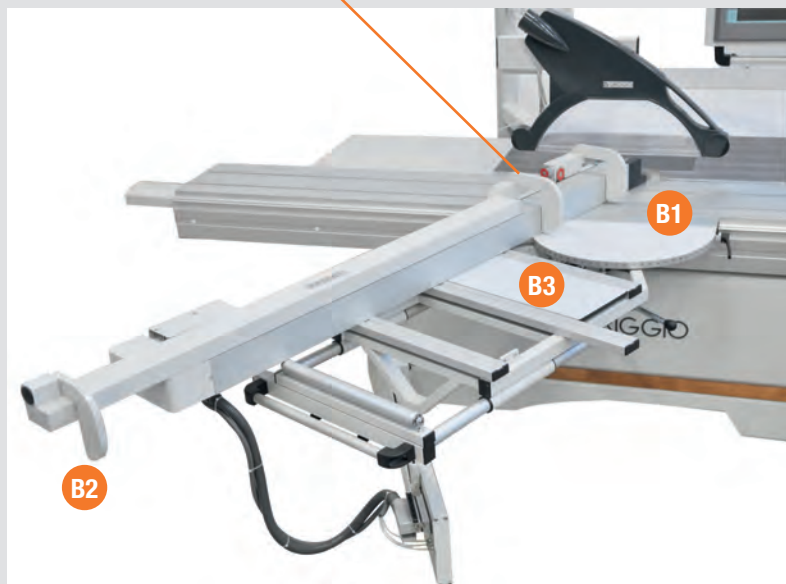

CARRO INCLINABILE +47° -47°
CHARIOT INCLINABLE +47° -47°
CARRO ESCUADRADOR INCLINABLE +47° -47°

Il carro squadratore inclinabile +47° -47° compensa automaticamente la misura delle battute quando viene inclinato.
Le chariot inclinable +47° -47° compense automatiquement la mesure des butteés quand il est incliné.
 El carro escuadrador inclinable +47°-47° equilibra automáticamente la medida de los topes cuando es inclinado

OPTIONS UNICA 400 - UNICA 500

STANDARD UNICA 500 / OPTION UNICA 400

Fermo battuta con selezione rapida 5 posizioni e lettura con indicatore luminoso
 Buttée d'arrêt avec sélection rapide des 5 positions et lecture avec indicateur lumineux
 Tope con selección rápida 5 posiciones y lectura con indicador luminoso

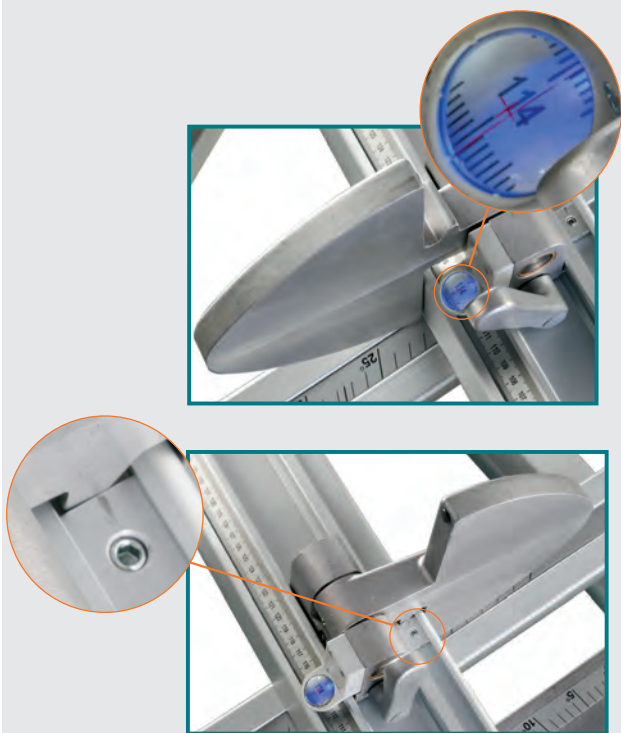

STANDARD UNICA E/DIGIT/PROGRAM

OPTION ONLY FOR UNICA 400



Inclinazione guida estensibile con compensazione della misura del fermo battuta

Inclinaison du guide extensible avec compensation de la mesure de la buttée d'arrêt

Inclinacion guía extensible con compensacion de la medida del tope

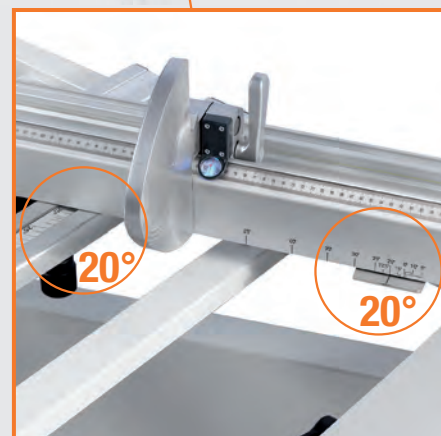

OPTION UNICA 400 - UNICA 500

Carro squadratore inclinabile con visualizzazione elettronica +47°-47°

Chariot équarisseur inclinable avec affichage électronique +50°-50°

Carro escuadrador inclinabile con visualizacion electronica +50°-50°

Standard

Visualizzazione elettronica
 Affichage électronique
 Visualizacion electronica

Compensazione misure carro inclinato con visualizzazione elettronica

Compensation de la mesure avec chariot incliné affichage électronique

Compensacion medidas con carro inclinado visualizacion electronica



+ 47°



- 47°



Option
Aviamento su carro scorrevole
Demarrage sur charriot
Arranque automatico dal carro



Option
Squadra Angolare doppia-tagli
inclinati 0°-45°
Guide angulaire double-coupes
inclinables 0°-45°
Escuadra angular doble-cortes
inclinados 0°-45°



Option
Lettore elettronico posizione
della guida parallela
Lecteur électronique position
du guide sur la table
Lector electrónico posicionamiento
tope paralelo



Option
Carro squadratore con estensione telescopica
Extension telescopiquechariot
equarisseur
Extension telescopicacarro ecuadrador

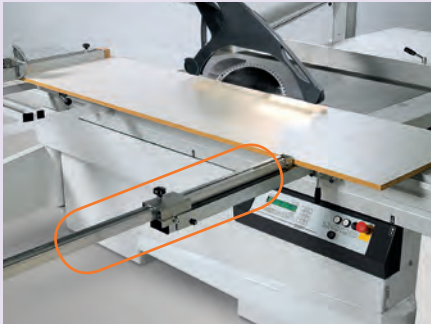

Option
Pianetto tagli paralleli
Tablette pour coupes parallèles
Mesa para cortes paralelos

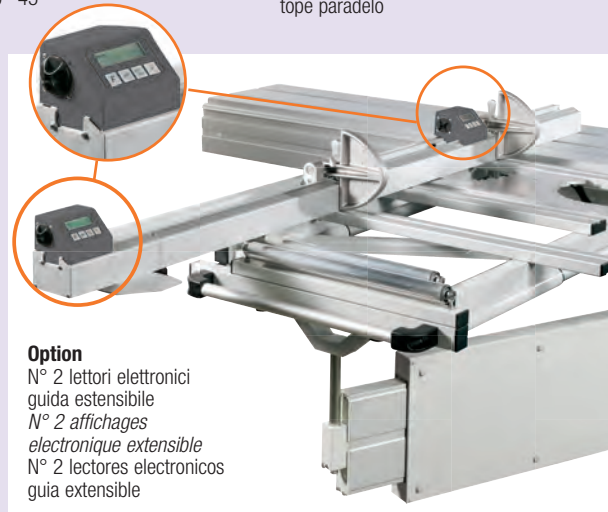

Option
N° 2 lettori elettronici
guida estensibile
N° 2 affichages
electronique extensible
N° 2 lectores electronicos
guia extensible

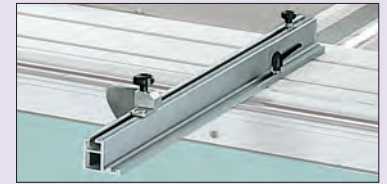

Option
Squadra in alluminio + 30° - 45°
Guide en aluminium + 30° - 45°
Escuadra en aluminio + 30° - 45°



Option



Option
Carro squadratore doppio per pannelli pesanti / *Chariot équarisseur double pour panneaux lourds* / Carro ecuadrador doble para paneles pesados



Option
Pressoio pneumatico. Taglio sicuro e di qualità su pannelli irregolari o pezzi sottili.
Pressoir pneumatique. Coupe ferme et de qualité sur des panneaux irréguliers ou sur des pièces minces Presor neumático. Corte seguro y de calidad para paneles irregulares y piezas sutiles.

p 154



Dati tecnici

Données Techniques - Datos Tecnicos

		UNICA 400	UNICA 500
Dimensioni del carro (a richiesta) <i>Dimensions du chariot (sur demande)</i> Medidas del carro (a pedido)	mm	385x3200 (3800-4300)	385x3200 (3800-4300)
Capacità di squadatura con incisione e carro <i>Capacité d'équarissage avec inciseur et chariot</i> Capacidad de escuadrar con incisor y carro	mm	L 2600 L 3200 L 3800 L 4300	2700 3260 3870 4200 3800
Con carro inclinabile +47° -47° / <i>Chariot inclinable +47°-47°</i> Carro escuadrador inclinable +47° -47°		L 4300	3800
Larghezza di taglio fra lama e guida parallela (a richiesta) <i>Largeur de coupe entre lame et guide parallele (sur demande)</i> Ancho de corte entre disco y tope paralelo (a pedido)	mm	UNICA UNICA E DIGIT 2	1250
		DIGIT PROGRAM	1600 (1050-1300)
Ø della lama <i>Ø de la lame</i> Ø disco	mm		400
			450 (550)*
Altezza di taglio <i>Hauteur de coupe</i> Altura de corte	mm		130
			155 (203)*

Altezza di taglio con lama 45° Ø <i>Hauteur de coupe avec lame 45° Ø</i> Altura de corte con disco a 45° Ø	mm		90	110(125)*
Lama inclinabile <i>Lame inclinable</i> Disco inclinabile	mm	UNICA UNICA E DIGIT 1	0°-46°	0° +46°
		DIGIT 2-3 PROGRAM	-1° +46°	-1° +46°
Velocità di rotazione dell'albero <i>Vitesse de rotation de l'arbre</i> Velocidad de rotación del eje	g/1' t/1' r/1		3200 4000 6000	3000 4000 5000 6000
Motore - <i>Motor</i> - Moteur	Kw (HP) CV		5,5(7,5)	5,5(7,5)
Gruppo Incisore / Groupe incisore / Grupo incisor				
Ø della lama <i>Ø de la lame</i> Ø disco	mm		125	125
Motore - <i>Motor</i> - Moteur	Kw (HP) CV		0,75 (1)	0,75 (1)

* Option

T210

TOUPIE / TOUPIES / TUPIS



T210



T210-PL

Piano a settore registrabile in sostituzione degli anelli (d)

Table à secteur réglable en échange des bagues (d)

Mesa a sector registrable en sustitucion de los anillos (d)

Option

OPTION
Programmazione
Meccanica
Programmation
Mecanique
Programacion
Mecanica



Riduce i tempi di messa a punto. Risolve ogni esigenza produttiva

- (a) Regolazione della guida in uscita rispetto al raggio (RM) minimo dell'utensile
- (b) Regolazione guida in entrata per la profondità di asportazione
- (c) Visualizzatore numerico per il posizionamento verticale dell'albero

Il réduit les temps de mise au point et résout toute exigence productive

- (a) Réglage du guide en sortie par rapport au rayon (RM) minimum de l'outil.
- (b) Réglage du guide en entrée pour la profondeur d'extirpation
- (c) Afficheur numérique pour le positionnement vertical de l'arbre..

Reduce los tiempos de puesta en marcha. Resuelve cada exigencia productiva

- (a) Regulación de la guía en salida con respecto al radio mínimo (RM) de la herramienta.
- (b) Regulación guía en entrada para la profundidad de corte.
- (c) Visualizador numérico para el posicionamiento vertical del eje.

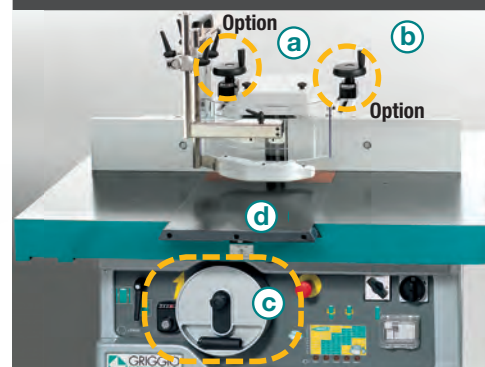
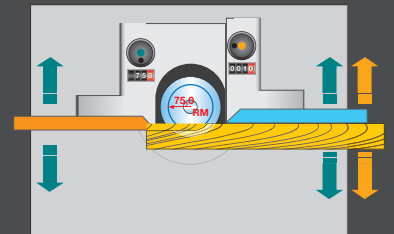



T210-TC

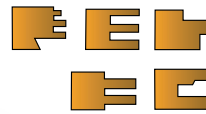

T210-TR

Accessori Accessoires Accesorios

STANDARD CE

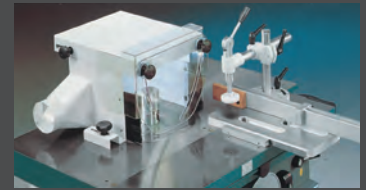

Option (T210-TC)

- Piano per tenonare • Pressallegno ad eccentrico
- Table à tenonner • Pressebois excentrique
- Mesa a espigar • Prensamadera excentrico



Option

Supporto esclusione guida.

Il sistema di esclusione totale della guida dal piano di lavoro e di rapido riposizionamento, permette la facile messa a punto della macchina per esecuzione di lavori di tenonatura e lavorazioni all'albero di pezzi curvi.

Support pour l'exclusion du guide.

Le système d'exclusion totale du guide de la table de travail de re-positionnement rapide permet la mise au point facile de la machine pour exécuter les travaux de tenonnage et les travaux de l'arbres des pièces incurvés.

Soporte exclusion guía.

El sistema de exclusion total de la guía de la mesa de trabajo y de rapido posicionamiento, permite la facil puesta en marcha de la máquina para hacer trabajos de espigadura y trabajos al eje de piezas encorvadas.

p 154



Dati tecnici

Données Techniques - Datos Tecnicos

		T 210	T 210 TR	T210 TPL	T 210 TC
Dimensioni del piano di lavoro (carro) Dimensions de la table de travail (chariot) Dimensiones mesa de trabajo (carro)	mm	1200x730	1200x730	2550x730	1115x790 (1115x245)
Albero: - lunghezza utile Arbre: - longueur utile Eje: - largo útil	Ø 30-35 Ø 40-50 Ø 50	140 160	140 160	140 160	140 160
n° 5 velocità di rotazione n° 5 vitesses de rotation n° 5 velocidades de rotación	g./l' t./l' r./l'	1500-3000 4300-6000-9000	1500-3000 4300-6000-9000	1500-3000 4300-6000-9000	1500-3000 4300-6000-9000
Diametro degli anelli sul piano Diamètre des anneaux sur la table Diametro de los anillos sobre la mesa	mm	115-170-220 270-350	115-170-220 270-350	115-170-220 270-350	115-170-220 270-350
Potenza motore Puissance moteur Potencia motor	KW (HP) KW (CV) KW (CV)	4 (5,5)	—	—	—
Carro per tenonare: - dimensioni del piano di lavoro Chariot à tenonner: - dimensions de la table de travail carro a espigar: - dimensiones mesa de trabajo	—	750x300	—	1115x254	—
Corsa del carro per tenonare Déplacement du chariot à tenoner Recorrido del carro a espigar	mm	—	900	—	900

T220 - T270

TOUPIE / TOUPIES / TUPIS

T 220



T 270



T220-T270



T220 - TPL

Gruppo recupero listello
per una migliore e completa
lavorazione degli elementi
delle finestre.

Groupe récupération
de la para close pour
un meilleur et complet travail
des éléments des fenêtres.

Grupo recuperacion liston
para un mejor y completo trabajo
de los elementos de las ventanas.

**Programmazione
Meccanica
Programmation
Mecanique
Programacion
Mecanica**



**Riduce i tempi di messa a punto.
Risolve ogni esigenza produttiva**

(a) Regolazione della guida in uscita rispetto al diametro minimo dell'utensile
(b) Regolazione guida in entrata (option) per la profondità di asportazione
(c) Visualizzatore numerico per il posizionamento dell'albero(d) Piano con settore regolabile in sostituzione degli anelli, per ottenere il massimo piano di appoggio (option).

Il réduit les temps de mise au point et résout toute exigence productive

(a) Réglage du guide en sortie par rapport au diamètre minimum de l'outil. (b) Réglage du guide en entrée (option) pour la profondeur d'extripation
(c) Afficheur numérique pour le positionnement de l'arbre.(d) Table avec secteur réglable en remplacement des bagues pour le maximum de la table d'appui (option).

Reduce los tiempos de puesta en marcha. Resuelve cada exigencia productiva

(a) Regulacion de la guía en salida con respecto al diámetro mínimo de la herramienta. (b) Regulacion guía en entrada (option) para la profundidad de separacion. (c) Visualizador numerico para el posicionamiento del eje.
(d) Mesa con sector regulable en sustitucion de los anillos, para obtener la maxima mesa de apoyo (option).

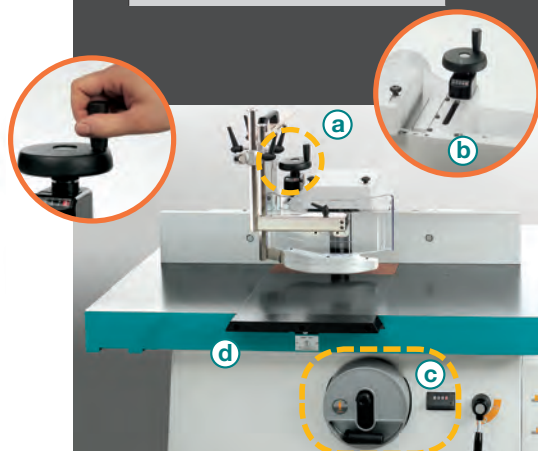
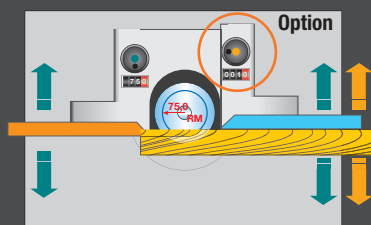

Standard

Versione TPL per profilare pezzi di grandi dimensioni

Gruppo recupero listello per una migliore e completa lavorazione degli elementi delle finestre. Obbligatorio: Toupie in versione TPL - Guida visualizzata - Piani in alluminio sulla guida - Avanzamento a 6 rulli GA8/68

Modèle TPL pour profiler des pièces de grandes dimensions.

Groupe récupération de la paraclose pour un meilleur et complet travail des éléments des fenêtres. Il est obligatoire: Toupie en version TPL - Guide affichée - Table en aluminium sur la guide - Entraînement à 6 rouleaux GA8/68.

Version TPL para perfilar piezas grandes.

Grupo recuperacion liston para un mejor y completo trabajo de los elementos de las ventanas. Obligatorio: Tupi en version TPL - Guia visualizada - Mesa en aluminio en la guia - Alimentador a 6 rodillos GA 8/68

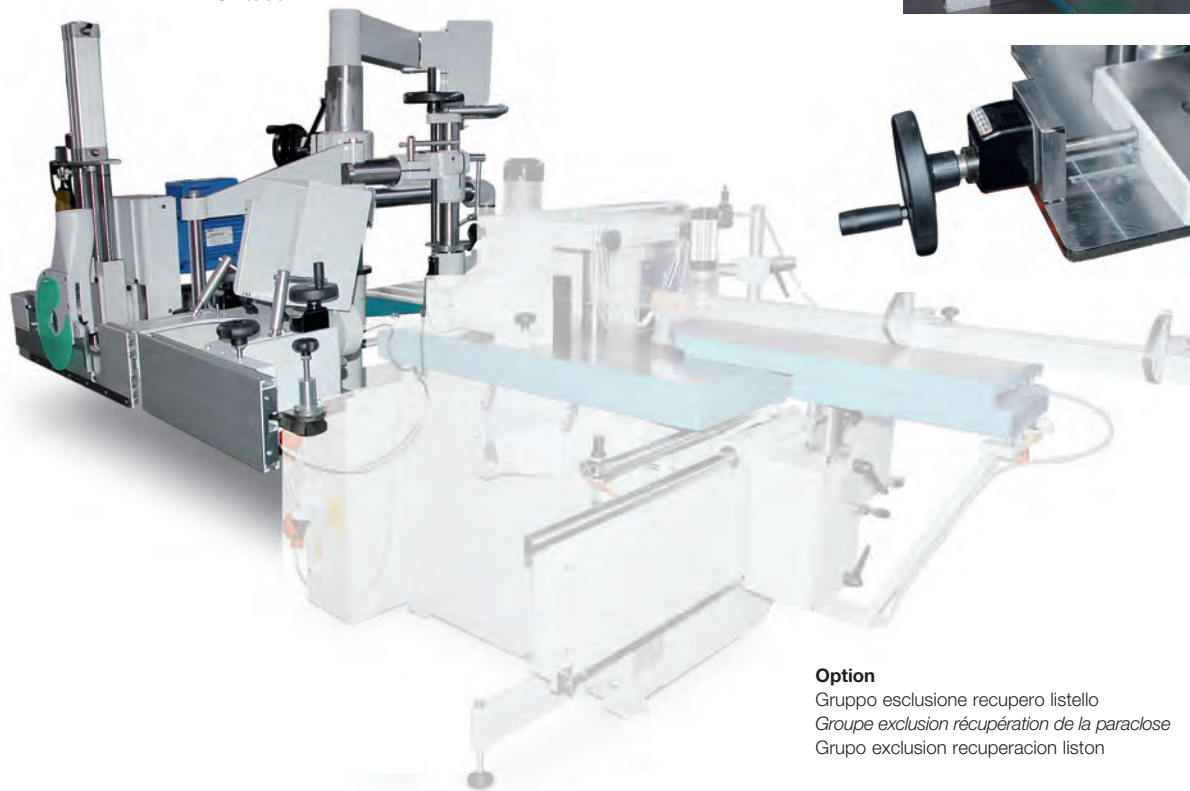

Option

Gruppo esclusione recupero listello
Groupe exclusion récupération de la paraclose
Grupo exclusion recuperacion liston



CE

T220 - TPL / T270 - TPL



T220 T - T270 T

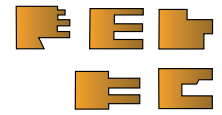

CE

Versione T Toupie carro per tenonare
Version T Toupie Chariot à tenonner
Version T Tupi carro para espigar

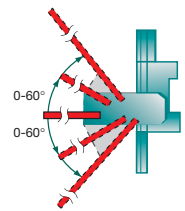

T220 T-PL - T270 T-PL

CE

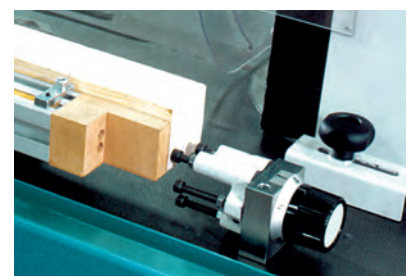

Option



Option

T220 - T270



TOUPIE / TOUPIES / TUPIS

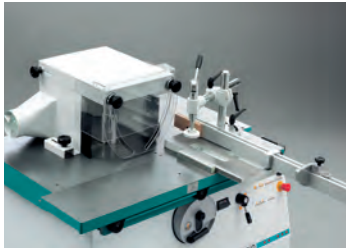

Option (T220-TC)

- Piano per tenonare • Pressalegno ad eccentrico
- Table à tenonner • Pressebois excentrique
- Mesa a espigar • Prensamadera excentrico

Versione TC con carro
Version TC avec chariot
Version TC con carro

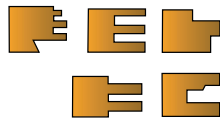

T220 TC

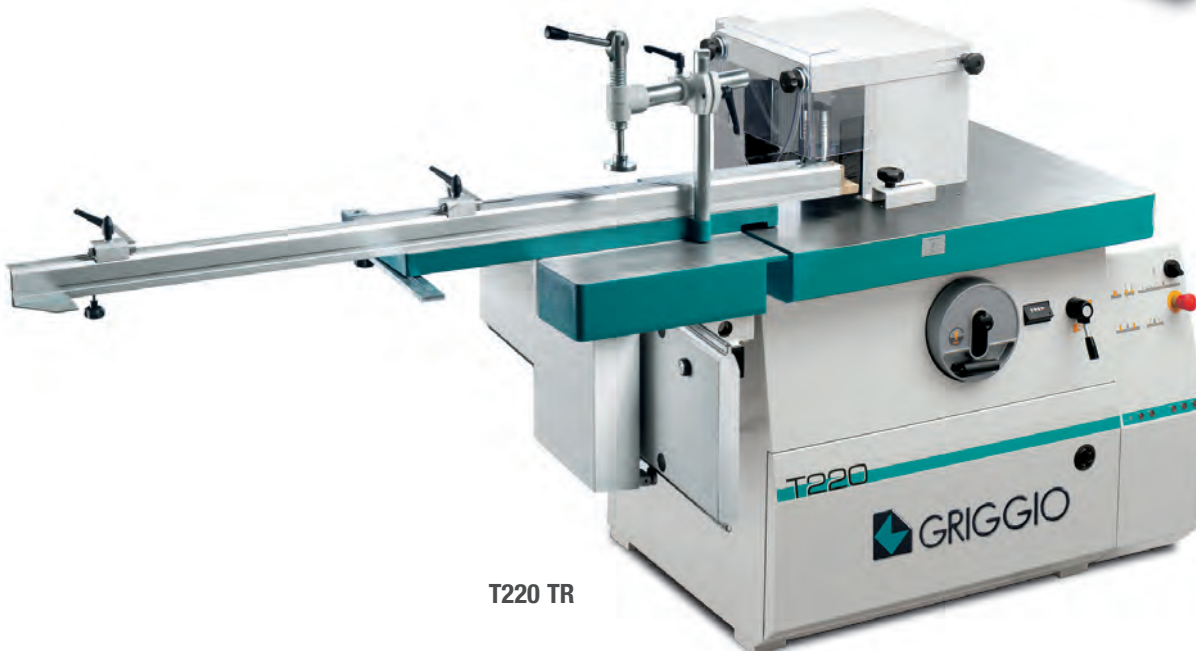

T220 TR

CE

Versione TR - Toupie con carro per tenonare
Version TR - Toupie avec chariot à tenonner
Version TR - Tupi con carro para espigar



T220 HSK 63 E

CON BLOCCAGGIO A CAMBIO RAPIDO
 AVEC BLOCAGE A CHANGEMENT RAPIDE
 CON BLOQUEO A CAMBIO RAPIDO

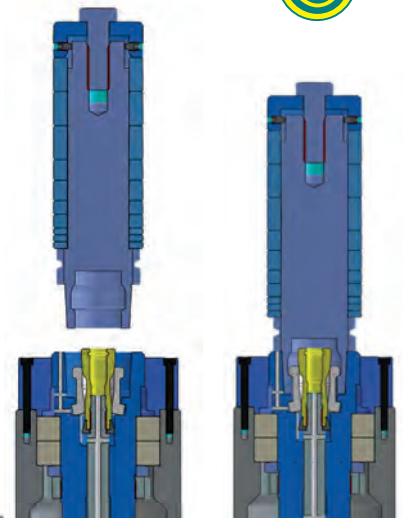

Ø del cono Ø du cône Ø del cono	mm	48
Altezza del cono Hauteur du cône Altura del cono	mm	32
Forza di bloccaggio (Newton) Force du blocage (Newton) Fuerza de bloqueo (Newton)	n.	25.000

Option

HSK 63 E DISPONIBILE NELLE VERSIONI / HSK 63 EST DISPONIBLE DANS LES MODELES / HSK 63 E DISPONIBLE EN LAS VERSIONES

Digit 1



Standard
Video 3,8"

- Posizionamento automatico dell'albero
- Programmatore Siemens touch screen 3,8"
- Inverter 900-12000 g/1'
- Guida visualizzata in uscita

- Positionnement automatique de l'arbre
- Programmeur Siemens touch screen 3,8"
- Inverter 900-12000 t/1'
- Guide afficheur en sortie
- Tablette à secteur manuel

- Posicionamiento automatico del eje
- Programador Siemens touch screen 3,8"
- Inverter 900-1200 rpm
- Guia visualizada en salida



Digit 2

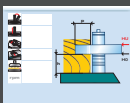

Standard
Video 5,7"

- Posizionamento automatico della guida e del sollevamento dell'albero
- Programmatore Siemens touch screen 5,7"
- Inverter 900-12000 g/1'
- Guida visualizzata in entrata

- Positionnement automatique du guide et de la montée de l'arbre
- Programmeur Siemens touch screen 5,7"
- Inverter 900-12000 t/1'
- Guide affiché en entrée
- Tablette à secteur manuelle

- Posicionamiento automatico de la guía y la subida del eje
- Programador Siemens touch screen 5,7"
- Inverter 900-1200 rpm
- Guia visualizada en entrada



Program 2



Standard
Video 5,7"

- Posizionamento automatico della guida e del sollevamento dell'albero
- Inverter 900-12000 g/1'
- Programmatore Siemens touch-screen a colori 5,7" (optional 10")
- Guida visualizzata in entrata
- Quadro comandi su pensile
- Vite a ricircolo di sfere per sollevamento albero
- Pianetto a settore manuale

- Positionnement automatique du guide et de la montée de l'arbre
- Inverter 900-12000 t/1'
- Programmeur Siemens touch-screen à couleur 5,7" (optionnel 10")
- Guide affiché en entrée
- Panneau de commande sur potence
- Vis à recircles de billes pour montée de l'arbre
- Tablette à secteur manuelle

- Posicionamiento automatico de la guía y la subida del eje
- Inverter 900-1200 rpm
- Programador Siemens touch screen a colores 5,7" (a pedido 10")
- Guia visualizada en entrada
- Cuadro de mando a pensil
- Tornillo a recirculo de bolas para subida eje
- Mesa a sector manual

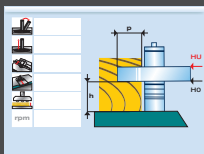

Option
Video 10"

T220 - T270 DIGIT 1



TOUPIE / TOUPIES / TUPIS

DIGIT 1



STANDARD



Touch Screen 3,8"



DIGIT 1

Guida protezione albero registrabile con visualizzazione digitale numerica sul lato in uscita e traslazione in relazione al diametro dell'utensile.

Guide protection arbre enregistrable avec affichage digitale numérique et translation en rapport au diamètre de l'outil positionné sur le côté en sortie.

Guía protección eje registrable con visualizador digital numerico puesto en el lado de salida y desplazamiento en relación al diam. de la herramienta.

OPTION

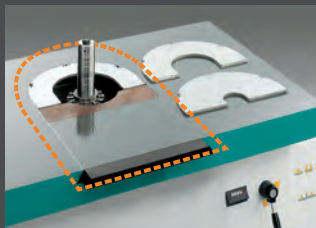

Piano con settore mobile
Table avec secteur réglable
Mesa con sector móvil



OPTION

T220 DIGIT 1
T270 DIGIT 1

Riduce i tempi di messa a punto e risolve ogni esigenza produttiva:

T220 DIGIT 1 Programmazione sollevamento dell'albero

La T 220 DIGIT è dotata di programmatore elettronico touch screen che controlla il movimento sequenziale dell'albero. Aggiungendo l'opzione dell'Inverter, memorizza anche la velocità di rotazione dell'albero.

Il programma è dotato di tasto di memorizzazione rapida utilizzabile quando si effettua la messa a punto dell'utensile in manuale con regolazione a (2 velocità) o in semiautomatico. Si possono memorizzare fino a 100 quote di lavoro. La semplicità d'uso del programma elimina i passaggi di prova e assicura una rapida regolazione dell'utensile.



Le programme réduit les temps de mise à point et résout toute exigence productive:

T220 DIGIT 1 Programmation montée dell'arbre

La T 220 DIGIT est équipée par un programmeur électronique touch screen qui contrôle le mouvement séquentiel de l'arbre.

En ajoutant l'option de l'Inverter, il met en mémoire la vitesse de rotation de l'arbre. Le programme est pourvu d'une touche de mise en mémoire rapide utilisable quand on fait une mise à point de l'outil en semi-automatique ou en manuel avec réglage rapide à deux vitesses. Il est possible de mettre en

mémoire jusqu'à 100 cotes de travail. La simplicité de l'emploi du programme annule les passages d'essais et assure un rapide réglage de l'outil.



Reduce los tiempos de puesta en marcha y resuelve cada exigencia productiva:

T220 DIGIT 1 Programacion subida del eje

La T220 DIGIT tiene un programador electrónico touch screen que controla el movimiento secuencial del eje. Poniendo el Inverter es posible memorizar también la velocidad de rotación del eje.

El programa tiene una tecla de memorización rápida que se puede utilizar cuando se hace la puesta en marcha de la herramienta en semi-automático o en manual con regulación rápida a 2 velocidades.

Es posible memorizar hasta 100 cotas de trabajo.

La simplicidad de empleo de este programa elimina las pruebas y asegura una rápida regulación de la herramienta.

T220 - T270 PROGRAM 2

PROGRAM 2



STANDARD

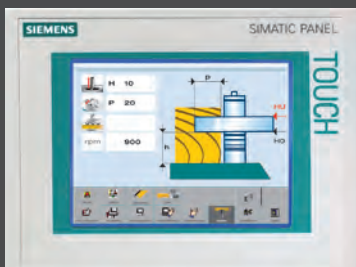

SIEMENS SIMATIC 5,7"



- (b) Vite a ricircolo di sfere.
- (c) Albero di supporto al gruppo.

- (b) Vis à re-circulation de billes
- (c) Arbre de support au groupe.

- (b) Tornillo a recirculo de bolas.
- (c) Eje de soporte al grupo.

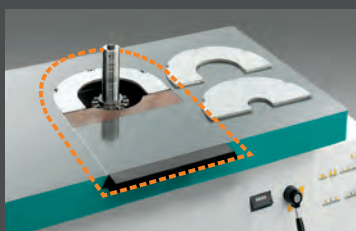

Piano con settore mobile
Table avec secteur réglable
Mesa con sector móvil



OPTION - Touch Screen Siemens 10" colori



T220/T270 PROGRAM 2



Dati tecnici

Données Techniques - Datos Técnicos

		T 220	T 270	T 220-TC
Dimensioni del piano di lavoro (carro) Dimensions de la table de travail (chariot) Dimensiones de la mesa de trabajo (carro)	mm	1200x730	1200x730	1115x790 (1115x245)
Albero: - lunghezza utile Arbre: - hauteur utile Eje: - largo útil	mm	(\varnothing 30-35 -1"1/4) 140 (\varnothing 40-50) 180	(\varnothing 40) 240 (\varnothing 50) 270	(\varnothing 30-35 -1"1/4) 140 (\varnothing 40-50) 180
n° 5 velocità di rotazione n° 5 vitesses de rotation n° 5 velocidades de rotación	g/1' r/1'	3000-4500-6000 8000-10000	3000-4500-6000 8000-10000	3000-4500-6000 8000-10000
Diametro degli anelli sul piano Diamètre des bagues sur la table Diametro de los anillos sobre la mesa	mm r/1'	115-170-220-270 350	115-170-220-270 350	115-170-220-270 350
Diametro max utensile a profilare Diamètre maxi de l'outil à profiler Diametro max herramienta a perfilar	mm	260	260	260
Diametro max utensile a tenonare sopra al piano Diamètre maxi de l'outil à tenonner sur la table Diametro max herramienta a espigar sobre la mesa	mm	350	350	350 (optional)
Dimensioni max dell'utensile rientrabile sotto il piano di lavoro Dimensions maxi de l'outil escamotable sous la table de travail Dim. max. de la herramienta bajo la mesa de trabajo	mm	320x90	320x180	320x90
Potenza motore Puissance moteur Potencia motor	KW(HP) KW(CV) KW(CV)	5,5 (Hp 7,5)	5,5 (Hp 7,5)	5,5 (Hp 7,5)
Carro per tenonare (T) - Dimensione del piano inclinabile +60°-60° Chariot à tenonner (T) - Dimensions de la table inclinabile +60°-60° Carro a espigar (T) - Dimensiones de la mesa inclinabile +60°-60°	mm	900x330	900x330	—
Inclinazione del piano (T) Inclinaison de la table (T) Inclinacion mesa (T)		+60° -60°	+60° -60°	—
Carro per tenonare (TR) - dimensione del piano Chariot à tenonner (TR) - dimensions de la table de travail Carro a espigar (TR) - dimensiones de la mesa de trabajo	mm	750x300	750x300	—

STANDARD CE

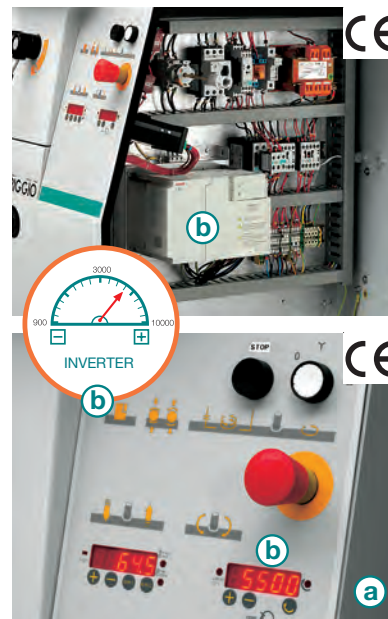

Option

(a) Quadro comandi con: visualizzatore digitale elettronico delle quote per il posizionamento dell'albero.

(b) Inverter

La nuova generazione delle T220 - T270 possono essere dotate della regolazione elettronica della velocità di rotazione dell'albero con Inverter. Esso permette di regolare la velocità in funzione dell'utensile montato e del tipo di materiale in lavorazione ottenendo così il massimo risultato in finitura.

Con la velocità iniziale di 900 g/1' si possono eseguire lavorazioni di levigatura.

La scelta della velocità desiderata si effettua direttamente dal quadro comandi con l'apposito selettore elettronico con visualizzatore digitale.

(a) Panneau commandes sur potence: afficheur digital électronique des cotes pour le positionnement de l'arbre

(b) Inverter

La nouvelle génération des T220 - T270 peut être équipée par des réglages électroniques de la vitesse de rotation de l'arbre avec Inverter. Il permet de régler la vitesse en fonction de l'outil monté et du matériel de usinage

en obtenant de cette façon un excellent résultat de finissage. Par la vitesse initiale de 900 t/1', il est possible d'effectuer des travaux de dressage. Le choix de la vitesse souhaitée s'effectue directement du panneau commandes par le spécial sélecteur électronique avec afficheur digitale.

(a) Cuadro de mandos con: visualizador digital electrónico de las cotas para el posicionamiento del eje.

(b) Inverter

la nueva generación de las T 220 - T 270 pueden tener la regulación electrónica de la velocidad de rotación del eje con Inverter, que permite la regulación de la velocidad en base a las herramientas montada y al tipo de material en trabajo obteniendo el máximo resultado en finición. Con la velocidad inicial de 900 r/1' es posible hacer trabajos de lijadura. La elección de la velocidad deseada se hace por medio de un cuadro de mandos que tiene un específico selector electrónico con visualizador digital.

ACCESSORI - ACCESSOIRES - ACCESORIOS



Option MK5



Option

Piano con settore mobile
Table avec secteur réglable
Mesa con sector regulable



Option

Supporto esclusione guida.

Il sistema di esclusione totale della guida dal piano di lavoro e di rapido riposizionamento, permette la facile messa a punto della macchina per esecuzione di lavori di tenonatura e lavorazioni all'albero di pezzi curvi.

Support pour l'exclusion du guide.

Le système d'exclusion totale du guide de la table de travail de re-positionnement rapide permet la mise au point facile de la machine pour exécuter les travaux de tenonnage et les travaux de l'arbres des pièces incurvés.

Soporte exclusion guía.

El sistema de exclusion total de la guía de la mesa de trabajo y de rapido posicionamiento, permite la facil puesta en marcha de la máquina para hacer trabajos de espigadura y trabajos al eje de piezas encorvadas.

Option

Dispositivo di supporto per avanzamento applicabile al quadro comandi a pensile

Dispositif de support pour entraînement applicable au panneau sur potence.

Dispositivo de soporte paraalimentador aplicable en el cuadro de mando a pensil

TOUPIES CON ALBERO INCLINABLE
TOUPIES AVEC ARBRE INCLINABLE
TUPIS CON EJE INCLINABLE



T 45 I



VANTAGGI!

Avantages! / ! Ventajas!

- L'inclinazione dell'albero +45° -45° consente l'utilizzo corretto dell'avanzamento per qualsiasi tipo di lavorazione, con pezzi anche di piccole dimensioni, riducendo i rischi di incidente.
- L'inclinaison de l'arbre +45° -45° permet l'utilisation correcte de l'entraîneur pour n'importe quel travail, même avec des pièces de petites dimensions, en réduisant les risques d'accident.
- L'inclinación del eje +45°-45° permite de utilizar corectamente del avance de la pieza con cualquier trabajo, también con piezas de pequeñas medidas, reduciendo los riesgos de accidente.

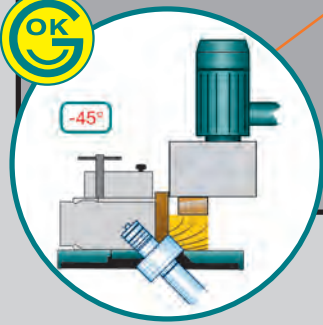
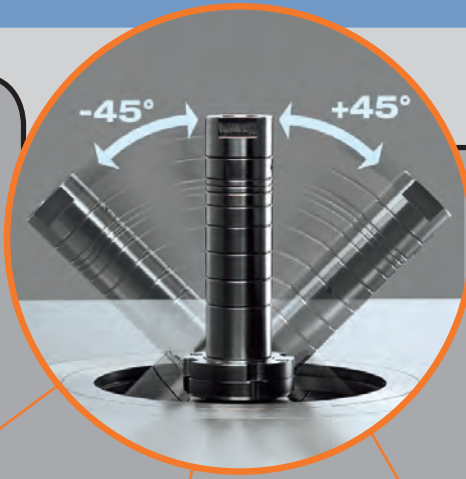

Supporto esclusione guida.

Il sistema di esclusione totale della guida dal piano di lavoro e di rapido riposizionamento. Permette la facile messa a punto della macchina per esecuzione di lavori di tenonatura e lavorazioni all'albero di pezzi curvi.

Support pour l'exclusion du guide.

Le système d'exclusion totale du guide de la table de travail de re-positionnement rapide. Il permet la mise au point facile de la machine pour exécuter les travaux de tenonnage et les travaux de l'arbre des pièces incurvées.

Soporte exclusión guía.

El sistema de exclusión total de la guía de la mesa de trabajo y de rápido posicionamiento. Permite la fácil puesta en marcha de la máquina para hacer trabajos de espigadura y trabajos al eje de piezas encorvadas.



Option



Option

Dispositivo di supporto per avanzamento applicabile al quadro comandi a pensile
Dispositif de support pour entraînement applicable au panneau sur potence.
Dispositivo de soporte paraalimentador aplicable en el cuadro de mando a pensil

Option

Quadro comandi a pensile e orientabile
Panneau sur potence et orientable
Cuadro de mandos a pensil y orientable



Programmazione Meccanica Programmation Mécanique Programación Mecánica

Riduce i tempi di messa a punto. Risolve ogni esigenza produttiva

(a) Regolazione della guida in uscita rispetto al raggio (RM) minimo dell'utensile
(b) Regolazione guida in entrata per la profondità di asportazione (c) Visualizzatore numerico per il posizionamento verticale dell'albero (d) Volantino con indicatore gravitazionale dell'inclinazione dell'albero.

Il réduit les temps de mise au point et résout toute exigence productive

(a) Réglage du guide en sortie par rapport au rayon (RM) minimum de l'outil. (b) Réglage du guide en entrée pour la profondeur d'extirpation (c) Afficheur numérique pour le positionnement vertical de l'arbre. (d) Poignée avec indicateur gravitationnel de l'inclinaison de l'arbre.

Reduce los tiempos de puesta en marcha. Resuelve cada exigencia productiva

(a) Regulación de la guía en salida con respecto al radio mínimo (RM) de la herramienta. (b) Regulación guía en entrada para la profundidad de corte (c) Visualizador numérico para el posicionamiento vertical del eje. (d) Volante con indicador gravitatorio de la inclinación del eje.

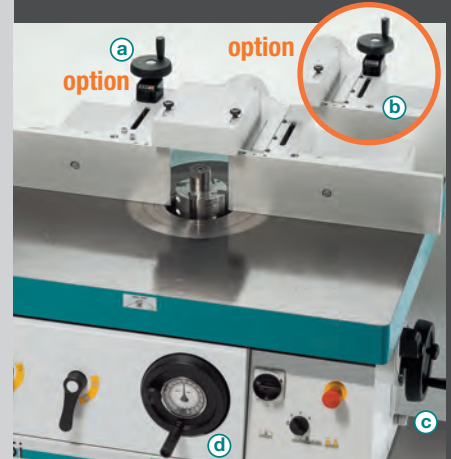
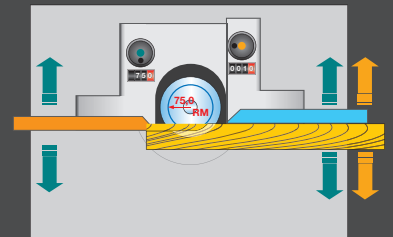

T 45 I



TOUPIE CON ALBERO INCLINABILE +45° -45°
TOUPIE AVEC ARBRE INCLINABLE +45° -45°
TUPI CON EJE INCLINABLE +45° -45°



CE

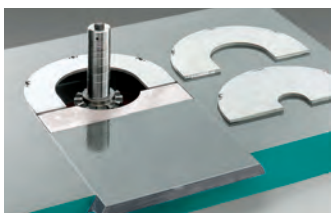

Option

Piano con settore mobile
Table avec secteur réglable
Mesa con sector regulable



T 45 I E

Con movimenti dell'albero motorizzati
Avec mouvements de l'arbre motorisés
Con movimientos del eje motorizados



T 45 I DIGIT 3

TOUPIE CON ALBERO INCLINABILE +45° -45°
 TOUPIE AVEC ARBRE INCLINABLE +45° -45°
 TUPI CON EJE INCLINABLE +45° -45°

DIGIT 3



T45 I DIGIT 3



STANDARD



Digit 3,8"

STANDARD



Digit 5,7"

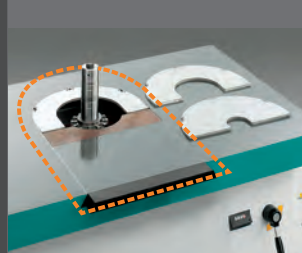
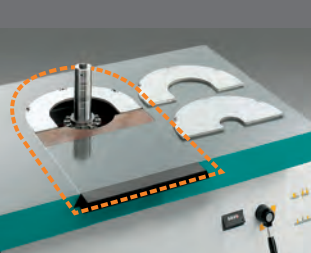

Piano con settore mobile
 Table avec secteur réglable
 Mesa con sector móvil

Piano con settore mobile
 Table avec secteur réglable
 Mesa con sector móvil

OPTION



RIDUCE I TEMPI DI MESSA A PUNTO E RISOLVE OGNI ESIGENZA PRODUTTIVA

T45 I DIGIT 3: programmazione sollevamento inclinazione dell'albero e della guida. La T 45 è dotata di programmatore elettronico touch screen che controlla il movimento sequenziale dell'albero. Aggiungendo l'opzione dell'Inverter, memorizza anche la velocità di rotazione dell'albero. Il programma è dotato di tasto di memorizzazione rapida utilizzabile quando si effettua la messa a punto dell'utensile in semiautomatico o in manuale con regolazione a 2 velocità. Si possono memorizzare fino a 100 quote di lavoro. La semplicità d'uso del programma elimina i passaggi di prova e assicura una rapida regolazione dell'utensile.



LE PROGRAMME RÉDUIT LES TEMPS DE MISE A POINT ET RÉSOUT TOUTE EXIGENCE PRODUCTIVE

T45 I DIGIT 3: programmation montée inclinaison de l'arbre et du guide. La T 45 est équipée par un programmeur électronique touch screen qui contrôle le mouvement séquentiel de l'arbre. En ajoutant l'option de l'Inverter, il met en mémoire la vitesse de rotation de l'arbre. Le programme est pourvu d'une touche de mise en mémoire rapide utilisable quand vous faites une mise à point de l'outil en semi-automatique ou en manuel avec réglage rapide à deux vitesses. Il est possible de mettre en mémoire jusqu'à 100 cotes de travail. La simplicité de l'emploi du programme annule les passages d'essais et assure un rapide réglage de l'outil.



REDUCE LOS TIEMPOS DE PUESTA EN MARCHA Y RESUELVE CADA EXIGENCIA PRODUCTIVA

T45 I DIGIT 3: programación subida y inclinación del eje de la guía. La T 45 tiene un programador electrónico touch screen que controla el movimiento secuencial del eje. Poniendo el Inverter es posible memorizar también la velocidad de rotación del eje. El programa tiene una tecla de memorización rápida que se puede utilizar cuando se hace la puesta en marcha de la herramienta en semi-automático o en manual con regulación rápida a 2 velocidades. Es posible memorizar hasta 100 cotas de trabajo. La simplicidad de empleo de este programa elimina las pruebas y asegura una rápida regulación de la herramienta.

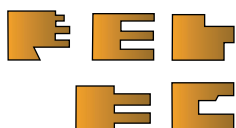

T 45 I TR



T 45 I TR/PL



T 45 I TPL

p 155



Dati tecnici

Données Techniques - Datos Tecnicos

T45 I

Dimensioni del piano di lavoro <i>Dimensions de la table de travail</i> Dimensiones de la mesa de trabajo	mm	1100x750
Dimensioni del piano di lavoro TPL <i>Dimensions de la table de travail TPL</i> Dimensiones de la mesa de trabajo TPL	mm	2435x750
Albero: - lunghezza utile <i>Arbre: - hauteur utile</i> Eje: - largo util	mm	(\varnothing 30-35 - 1"1/4) (\varnothing 40-50)
Inclinazione albero <i>Inclinaison arbre</i> Inclinación eje		+45°-45°
Altezza massima con albero inclinato a 45° <i>Hauteur maxi avec arbre inclinaison à 45°</i> Altura máxima con eje inclinado a 45°	mm	106 \varnothing 30-35 113 \varnothing 30-35 MK5 120 \varnothing 40-50 127 \varnothing 40-50MK5
N° 5 velocità di rotazione <i>5 vitesses de rotation</i> N°5 velocidades de rotación	g/1' v/1' r/1'	1500-3000-4300-6000-9000
Diametro degli anelli sul piano <i>Diamètre des bagues sur la table</i> Diametro de los anillos sobre la mesa	mm	115-170-220-270
Diametro max utensile a profilare <i>Diamètre maxi de l'outil à profiler</i> Diametro max herramienta a perfilar	mm	260
Diametro max utensile a tenonare <i>Diamètre maxi de l'outil à tenonner</i> Diametro max herramienta a espigar	mm	350
Dimensioni max dell'utensile rientrabile sotto il piano di lavoro <i>Dimensions maxi de l'outil escamotable sous la table de travail</i> Dim. max. de la herramienta bajo de la mesa de trabajo	mm	260 x 90 350 x 50
Potenza motore <i>Puissance moteur</i> Potencia motor	Kw(HP-CV)	4 (5,5)
Carro per tenonare TR - dimensione del piano <i>Chariot à tenonner TR - dimensions de la table de travail</i> Carro a espigar TR - dimensiones de la mesa de trabajo	mm	750x300

T 45

TOUPIE CON ALBERO INCLINABILE +45° -30°
 TOUPIE AVEC ARBRE INCLINABLE +45° -30°
 TUPI CON EJE INCLINABLE +45° -30°



Standard CE

Le macchine sono complete di:

- Piano con settore regolabile in sostituzione degli anelli sul piano
- Visualizzatori digitali elettronici sollevamento ed inclinazione albero
- Invertitore di rotazione.
- Piani in alluminio sulla guida.
- Protezione antinfortunistica.
- Protezione lavorazione all'albero.
- N. 2 bocche di aspirazione diam. 120 mm.
- Sollevamento ed inclinazione motorizzati.
- Avviamento stella-triangolo automatico.
- Normativa "CE".

Machine équipée de:

- Mesa con sector regolabile en sustitucion de los anillos en la mesa
- Visualizadores digitales electronicos subida y inclinacion eje
- Inverseur de rotation.
- Tables en aluminium sur le guide.
- Protecteur de sécurité.
- Protecteur travail à l'arbre.
- N. 2 buses d'aspiration diamètre 120 mm.
- Prise pour l'entraîneur.
- Montée et inclinaison motorisées.
- Démarrage étoile-triangle automatique.
- Normes "CE".

La maquina es completa de:

- Table avec secteur réglable en remplacement des bagues sur la table
- Afficheurs digitaux électroniques montée et inclination de l'arbre
- Invertitor de rotacion.
- Mesas en aluminio en la guía.
- Proteccion de seguridad.
- Proteccion trabajo al eje.
- N. 2 bocas de aspiracion diam. 120 mm.
- Subida y inclinacion motorizados.
- Arranque estrella-triángulo automatico.
- Normativa CE.



T 45



Standard

Guida protezione albero registrabile con visualizzazione digitale numerica sul lato in uscita e traslazione in relazione al diametro dell'utensile, (diam. max. utensile 260 mm.)

Guide protection arbre enregistrable avec affichage digitale numérique et translation en rapport au diamètre de l'outil positionné sur le côté en sortie (diamètre maxi outil 260 mm.).

Standard

Piano con settore mobile
 Table avec secteur réglable
 Mesa con sector regulable

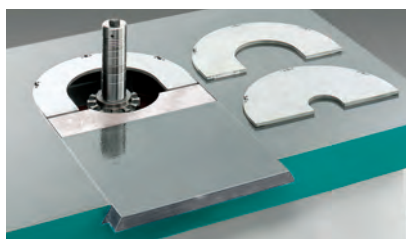

Guia proteccion eje registrable con visualizador digital numerico puesto en el lado de salida y desplazamiento en relacion al diam. de la herramienta (diam. max herramienta 260 mm.).



T 45 T-PL

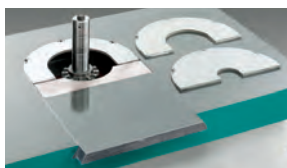

Standard



Standard



T 45 T

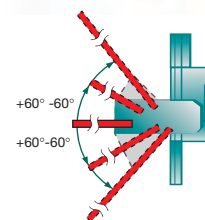

Options

p 155



Dati tecnici

Données Techniques - Datos Tecnicos

T45

Dimensioni del piano di lavoro <i>Dimensions de la table de travail</i> Dimensiones mesa de trabajo	mm	1200x730
Dimensioni del piano di lavoro TPL <i>Dimensions de la table de travail TPL</i> Dimensiones de la mesa de trabajo TPL	mm	2500x730
Albero: - lunghezza utile <i>Arbre: - hauteur utile</i> Eje: - largo util		Ø 30-35 140 (140 MK5) Ø 40-50 180 (160 MK5)
Inclinazione albero <i>Inclinaison arbre</i> 5 velocidades de rotación		+45° -30°
N° 5 velocità di rotazione <i>N°5 vitesses de rotation</i> N°5 velocidades de rotación	g/1' t/1' r/1'	3000-4500-6000 8000-10000
Diametro max utensile a tenonare <i>Diamètre maxi de l'outil à tenonner</i> Diaméto max herramienta a espigar	mm	350
Dimensioni max dell'utensile rientrabile sotto il piano di lavoro <i>Dimensions maxi de l'outil escamotable sous la table de travail</i> Dim. max. de la herramienta bajo la mesa de trabajo	mm	320x140
Potenza motore Kw (HP) <i>Puissance moteur Kw (CV)</i> Potencia motor Kw (CV)		5,5 (7,5)
Carro per tenonare / Chariot à tenonner / Carro para espigar		
Dimensioni del piano di lavoro <i>Dimensions de la table de travail</i> Dimensiones de la mesa de trabajo	mm	900x330
Inclinazione del piano di lavoro <i>Inclinaison de la table de travail</i> Diaméto max herramienta a perfilar	mm	+60° -60°

T45 ALBERO H 63 E

CON BLOCCAGGIO A CAMBIO RAPIDO
 AVEC BLOCAGE A CHANGEMENT RAPIDE
 CON BLOQUEO A CAMBIO RAPIDO

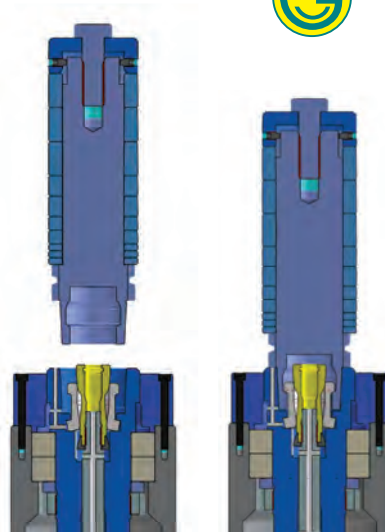

Ø del cono Ø du cône Ø del cono	mm	48
Altezza del cono Hauteur du cône Altura del cono	mm	32
Forza di bloccaggio (Newton) Force de blocage (Newton) Fuerza de bloqueo (Newton)	n.	25.000

Option

HSK 63 E DISPONIBILE NELLE VERSIONI / HSK 63 EST DISPONIBLE DANS LES MODELES / HSK 63 E DISPONIBLE EN LAS VERSIONES

Digit 4

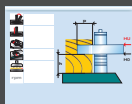

Standard
Video 5,7"

- Posizionamento automatico della guida, del sollevamento dell'albero e dell'inclinazione dell'albero
- Programmatore Siemens touch screen 5,7"
- Inverter 900-12000 g/1'
- Guida visualizzata in entrata
- Pianetto a settore elettronico

- Positionnement automatique du guide et de la montée de l'arbre
- Programmeur Siemens touch screen 5,7"
- Inverter 900-12000 t/1'
- Guide affiché en entrée
- Tablette à secteur électronique

- Posicionamiento automático de la guía y la subida del eje
- Programador Siemens touch screen 5,7"
- Inverter 900-12000 rpm
- Guía visualizada en entrada
- Mesa a sector electrónico



Program 4

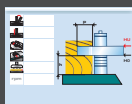

Standard
Video 5,7"

- Posizionamento automatico della guida, del sollevamento dell'albero e dell'inclinazione dell'albero
- Inverter 900-12000 g/1'
- Programmatore Siemens touch-screen a colori 5,7" (optional 10")
- Guida visualizzata in entrata
- Quadro comandi su pannello
- Vite a ricircolo di sfere per sollevamento albero
- Pianetto a settore elettronico

- Positionnement automatique du guide, de la montée de l'arbre et de l'inclination de l'arbre
- Inverter 900-12000 t/1'
- Programmeur Siemens touch screen 5,7" Optionnel 10"
- Guide affiché en entrée
- Vis à recircles de billes pour montée de l'arbre
- Tablette à secteur électronique

- Posicionamiento automático de la guía y la subida del eje
- Inverter 900-1200 rpm
- Programador Siemens touch screen a colores 5,7" (a pedido 10")
- Guía visualizada en salida
- Cuadro de mando a pannello
- Tornillo a recirculo de bolas para subida eje
- Mesa a sector electrónico

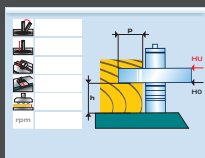

Option
Video 10"



T 45 DIGIT 4



TOUPIE CON ALBERO INCLINABILE +45° -30°
 TOUPIE AVEC ARBRE INCLINABLE +45° -30°
 TUPI CON EJE INCLINABLE +45° -30°

DIGIT 4



STANDARD

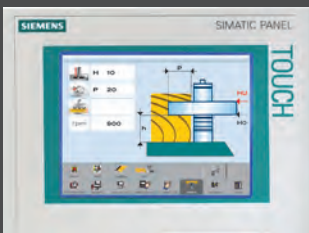

SIEMENS SIMATIC 5,7"

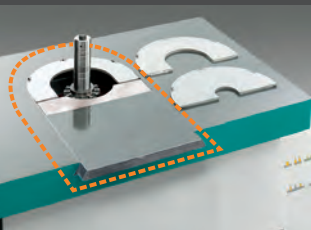

Piano con settore mobile
Table avec secteur réglable
Mesa con sector móvil



T45 DIGIT 4



RIDUCE I TEMPI DI MESSA A PUNTO E RISOLVE OGNI ESIGENZA PRODUTTIVA

T45 DIGIT 4: programmazione sollevamento inclinazione dell'albero, della guida e del piano settore. La T 45 è dotata di programmatore elettronico touch screen che con-trolla il movimento sequenziale dell' albero. Aggiungendo l'opzione dell'Inverter, memorizza anche la velocità di rotazione dell'albero. Il programma è dotato di tasto di memorizzazione rapida utilizzabile quando si effettua la messa a punto dell'utensile in semiautomatico o in manuale con regolazione a 2 velocità. Si possono memorizzare fino a 100 quote di lavoro. La semplicità d'uso del programma elimina i passaggi di prova e assicura una rapida regolazione dell'utensile.

LE PROGRAMME RÉDUIT LES TEMPS DE MISE A POINT ET RÉSOULT TOUTE EXIGENCE PRODUCTIVE

T45 DIGIT 4: programmation montée inclinaison de l'arbre du guide, du guide et de la table à secteur. La T 45 est équipée par un programmeur électronique touch screen qui contrôle le mouvement séquentiel de l'arbre. En ajoutant l'option de l'Inverter, il met en mémoire la vitesse de rotation de l'arbre. Le programme est pourvu d'une touche de mise en mémoire rapide utilisable quand vous faites une mise à point de l'outil en semi-automatique ou en manuel avec réglage rapide à deux vitesses.

Il est possible de mettre en mémoire jusqu'à 100 cotes de travail. La simplicité de l'emploi du programme annule les passages d'essais et assure un rapide réglage de l'outil.

REDUCE LOS TIEMPOS DE PUESTA EN MARCHA Y RESUELVE CADA EXIGENCIA PRODUCTIVA

T45 DIGIT 4: programación subida e inclinación del eje de la guía, de la guía y de la mesa a sector. La T 45 tiene un programador electrónico touch screen que controla el movimiento secuencial del eje. Poniendo el Inverter es posible memorizar también la velocidad de rotación del eje. El programa tiene una tecla de memorización rápida que se puede utilizar cuando se hace la puesta en marcha de la herramienta en semi-automático o en manual con regulación rápida a 2 velocidades. Es posible memorizar hasta 100 cotas de trabajo. La simplicidad de empleo de este programa elimina las pruebas y asegura una rápida regulación de la herramienta.

T 45 PROGRAM 4



TOUPIE CON ALBERO INCLINABILE +45° -30°
TOUPIE AVEC ARBRE INCLINABLE +45° -30°
TUPI CON EJE INCLINABLE +45° -30°

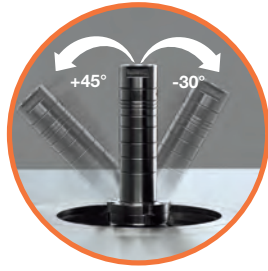

T 45 PROGRAM 4



Standard 5,7"



Option 10"



SNA - SNAC

SEGHE A NASTRO / SCIES À RUBAN / SIERRAS DE CINTA



SNA 400-500
600-700-800

SNAC 540-640
740-840-940



Guidalame con
inserto in ceramica

Guide lame avec
plaquette en ceramique

Guia con insertos
en ceramica
Option

p 156



Dati tecnici

Données Techniques - Datos Tecnicos

	SNA 400	SNA 500	SNA 600	SNA 700	SNA 800
Diametro volani / Diamètre des volants / Diametro rodillos	400	500	600	790	800
Giri volani / Rotation des volants / Rodillos	1240	960	800	790	625
Potenza motore / Puissance du moteur / Potencia motor	0,75 (1)	1,5 (2)	2,2 (3)	2,2 (3)	4 (5,5)
Altezza max. di taglio / Hauteur max. de coupe / Altura de corte	270	300	370	370	450
Larghezza max. di taglio / Largeur max. de coupe / Ancho de corte	390	480	580	680	780
Dimensioni tavolo di lavoro / Dimensions de la table Dimensiones de la mesa	400x500	500x640	600x830	700x970	750x1100
Sviluppo max-min lama / Longueur max.-min. de la lame Max.-min. largo de la sierra	3640-3560	4130-4050	4600-4520	5040-4990	5700-5630

	SNAC 540	SNAC 640	SNAC 740	SNAC 840	SNAC 940
Diametro volani / Diamètre des volants / Diametro rodillos	540	640	740	840	940
Giri volani / Rotation des volants / Rodillos	920	810	640	610	550
Potenza motore / Puissance du moteur / Potencia motor	1,5 (2)	2,2 (3)	3 (4)	4 (5,5)	5,5 (7,5)
Altezza max. di taglio / Hauteur max. de coupe / Altura de corte	350	400	450	520	560
Larghezza max. di taglio / Largeur max. de coupe / Ancho de corte	520	620	720	820	910
Dimensioni tavolo di lavoro / Dimensions de la table Dimensiones de la mesa	520x720	600x885	710x1000	800x1160	800x1250
Sviluppo max-min lama / Longueur max.-min. de la lame Max.-min. largo de la sierra	4260-4190	4800-4730	5420-5340	6110-6000	6710-6610

SNAC 740RS3 - 940RS3 - 940RS3 SPECIAL



SEGHE A NASTRO A REFENDERE
SCIE A' RUBAN A REFENDRE
SIERRA DE CINTA RECORTADORA



RAC 235
Option



RA 15
RA 21
Option

p 156



Dati tecnici

Données Techniques - Datos Tecnicos

		740RS3	940RS3	940RS3 SPECIAL
Diametro volani / Diamètre des volants / Diametro rodillos	mm	730	930	930
Giri volani / Rotation des volants / Rodillos	g/1' - t/1' - r/1'	680	570	570
Potenza motore / Puissance du moteur / Potencia motor	Kw (HP-CV)	9 (12,5)	11 (15)	11 (15)
Altezza max. di taglio / Hauteur max. de coupe / Altura de corte	mm	450	550	600
Larghezza max. di taglio / Largeur max. de coupe / Ancho de corte	mm	710	910	720
Dimensioni tavolo di lavoro / Dimensions de la table Dimensiones de la mesa	mm	860x1100	860x1100	860x1100
Lunghezza lama / Longueur de la lame Largo de la sierra	(min-max) mm	5310 - 5420	6580 - 6670	6580 - 6670
Larghezza max lama / Largeur max de ruban Ancho max sierra	mm	80x0,9	90x0,9	90x0,9

SW 640I - 3200/4300 S 740/1500 - 740/3200

Tagli angolati
Coupe angulaire
Corte angular



S740

Tagli dritti a 90°
Coupe droit 90°
Corte recto 90°

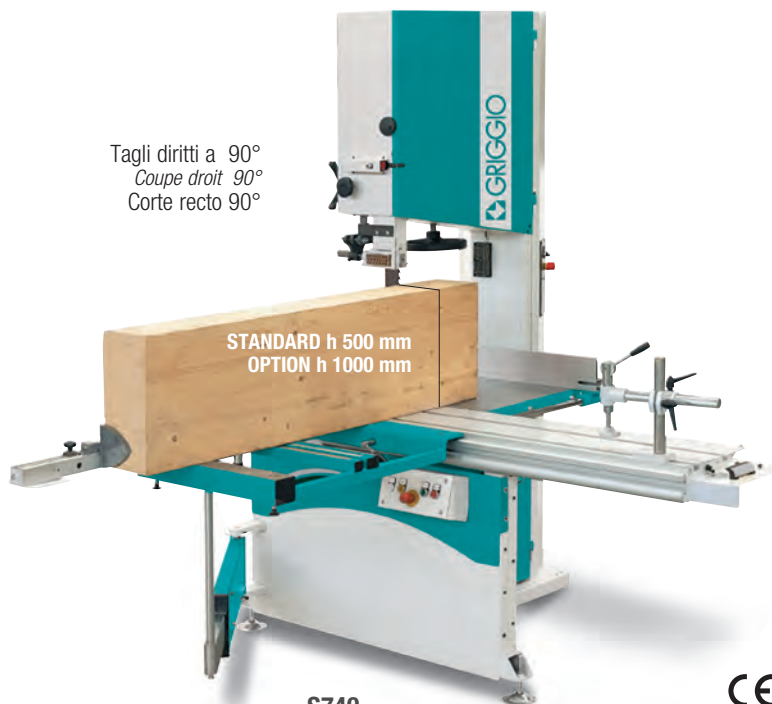

STANDARD h 500 mm
OPTION h 1000 mm

S740

CE

45°

Inclinazione motorizzata
Inclination motorisée
Inclinación motorizada



SW640I



CE

Patent

Diam. Min. - Max
50 - 500 mm



S740

CE

Tagli per grandi altezze
(standard 500 mm - A richiesta 1000 mm)
Coupe grand hauteur
(standard 500 mm selon requise jusqu'à 1000 mm)
Altura max de corte
(standard 500 mm - a pedido hasta 1000 mm)

PRISMA 740



SISTEMA DI PRISMATURA A DOPPIA LAMA
SYSTÈME A ÉQUARRIR À DEUX LAME
SISTEMA DE PRISMATURA DE DOBLE HOJA



CE





TRC/N - TRC/S

CAVATRICI A PUNTA CON PIANO FISSO E INCLINABILE A 45°
 MORTAISEUSES A MÊCHE AVEC TABLE FIXE ET INCLINABLE À 45°
 TALADRO DE BROCA CON MESA FIJA Y INCLINABLE A 45°



CE

TRC/N-I



Option



Option



TRC/N-I



Option

p 156

Dati tecnici

Données Techniques - Datos Técnicos

		TRC/N	TRC/S
Dimensioni del piano di lavoro Dimensions de la table de travail Dimensiones mesa de trabajo	mm	565x315	530x230
Corsa longitudinale della testa Déplacement longitudinal de la tête Carrera longitudinal del cabezal	mm	240	200
Corsa trasversale della testa Déplacement transversal de la tête Carrera transversal del cabezal	mm	130	200
Corsa verticale della testa Déplacement vertical de la tête Carrera vertical del cabezal	mm	130	200
Mandrino portapunta Ø Mandrin porte-mèche Ø taladro portabrocas	mm	0÷20	0-20
Velocità mandrino Vitesse du mandrin porte-mèche Velocidad del eje	g/1'-t/1'-r/1'	3000	2800
Potenza motore Puissance du moteur Potencia motor	Kw (HP) Kw (CV) Kw (CV)	1,5 (2)	1,5(2)



TRC/S

GF 21 - GF 23 - GF 27 - GF 35

FORATRICI MULTIPLE / PERCEUSES MULTIBROCHES / TALADRO MULTIPLE

Patent



Standard

Dispositivo rapido di programmazione e regolazione delle profondità di foratura.
Dispositif rapide de programmation et réglage des profondeurs de perçages.
 Dispositivo rápido de programación y regulación de la profundidad a taladrar.



Standard

Possibilità di foratura per cerniere con utensili di diametro massimo 40 mm.
Possibilité de perçage pour charnières avec outils diamètre maximum de 40mm.
 Posibilidad de horadación por bisagras con herramientas diámetro máximo de 40 mm.

CE



GF 21



Standard

Guida in alluminio da mm 3000 (1500+1500) con attacco rapido
Guide en aluminium de mm 3000 (1500+1500) avec attache rapide
 Guía en aluminio de mm 3000 (1500+1500) con ataque rapido



GF 23-27-35

p 157

Dati tecnici

Données Techniques - Datos Tecnicos

		GF 21	GF 23	GF 27	GF 35
Mandri Mandri Mandri	n.	21	23	27	35
Interasse fra ogni mandri Entre-axe entre cheque mandri Distancia entre cada mandri	mm	32	32	32	32
Interasse totale fra il primo e l'ultimo mandri Entre-axe total entre la première et le dernière mandri Distancia total entre el primero y el último mandri	mm	640	704	832	1088
Max. Spessore del pannello Maxi épaisseur du panneau Max. espesor del panel	mm	90	90	90	90
Profondità max. di foratura Profondeur de perçage maxi Profundidad máx. a taladrar	mm	65	65	65	85
Dimensioni del piano di lavoro Dimensions de la table de travail Dimensiones mesa de trabajo	mm	860x400	900x380	1050x380	1450x380
Dimensione max. del pezzo da forare Dimension maximum de la pièce à percer Dimensiones máx. de la pieza de taladrar	mm	850x3000	950x3000	990x3000	1300x3000
Giri mandri Vitesse de rotation des mandri Revoluciones mandri	g/1' t/1' r/1'	2800	2800	2800	2800
Potenza motore Puissance du moteur Potencia motor	Kw (HP) Kw (CV) Kw (CV)	1,5 (2)	1,5 (2)	1,5 (2)	1,5 (2)

Con 2 motori
 Avec 2 moteurs
 Con 2 motores





G65 5T - G63 3T

FORATRICE MULTIPLA A 3 TESTE
 PERCEUSE MULTIBROCHE À 3 TÊTES
 TALADRO MULTIPLE A 3 CABEZALES

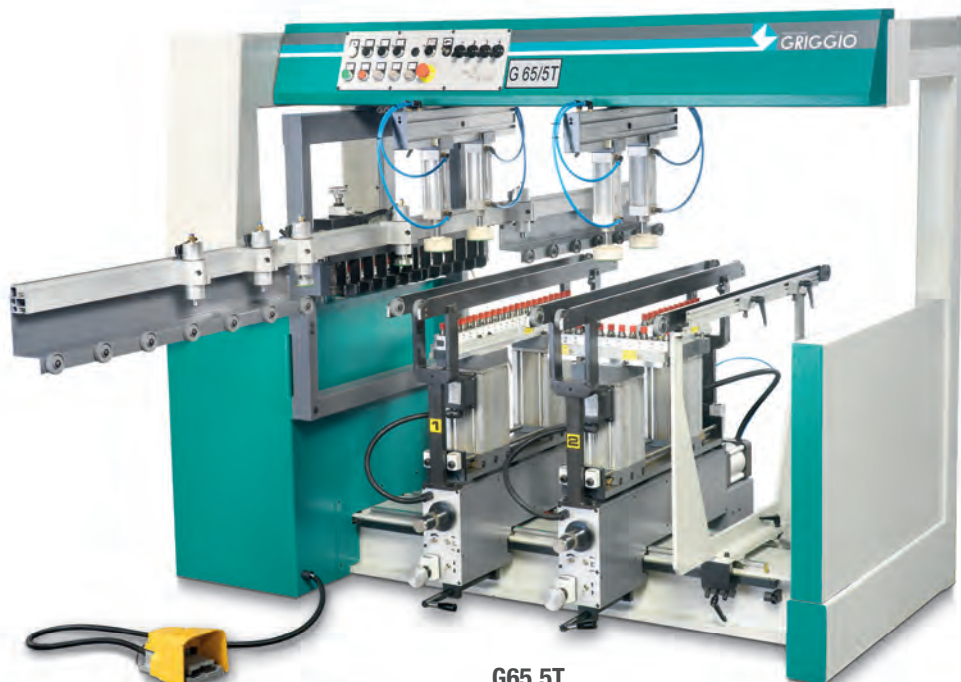
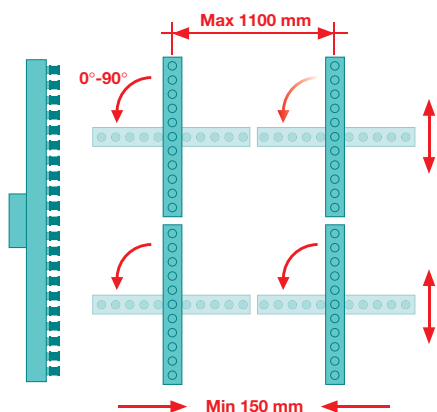

G65 5T

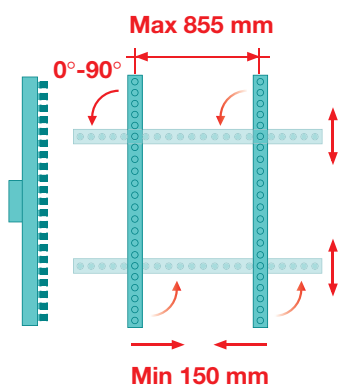

G63 3T

p 157



Dati tecnici

Données Techniques - Datos Tecnicos

	G65 5T	G63 3T
Interasse fra ogni mandrino Entre-axe entre chaque mandrins Distancia entre cada mandril	mm	32
Spessore massimo pannelli Max. épaisseur des panneaux Max. espesor de los paneles	mm	80
Profondità massima di foratura verticale (orizzontale) Max. profondeur de perçage verticaux (horizontal) Profundidad max. a taladrar vertical (horizontal)	mm	70
Velocità rotazione mandrini Vitesse de rotation des mandrins Velocidad rotación mandriles	g/l' t/1' r/1'	2800
Mandrini del gruppo orizzontale Mandrins du groupe horizontal Mandriles del grupo horizontal	n°	21
Mandrini dei gruppi verticali Mandrins des groupes verticaux Mandriles de los grupos verticales	n°	2x11 + 2x11
Distanza min-max. tra le teste verticali Largeur min-maxi entre les têtes verticales Distancia min-max. entre los cabezales verticales	mm	150-1100
Potenza motori Puissance des moteurs Potencia motores	KW(HP-CV)	1x 1,5(2) 4 x 1,1(1,5)

Schemi di foratura - Percages - Esquema de taladrado

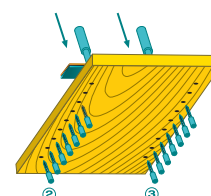
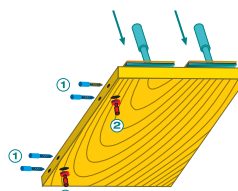
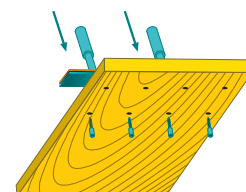
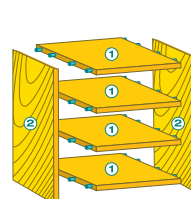

G60 I - G80 I - G90 I



FRESATRICI CON TESTA INCLINABILE
 DEFONCEUSES AVEC TÊTES INCLINABLE
 FRESEDORAS VERTICALES CON CABEZAL INCLINABLE

**G80 I BASIC****Standard****Option Basic
Standard CE**

p 157



Dati tecnici

Données Techniques - Datos Tecnicos

		G60 I	G80 I	G90 I
Testa inclinabile <i>Tête inclinable</i> Cabeza inclinable		0°-45°	0°-45°	0°-45°
Distanza fra albero e colonna <i>Distance entre arbre et colonne</i> Distancia entre eje y columna	mm	600	800	900
Corsa verticale del mandrino <i>Course vertical du mandrin</i> Recorrido vertical del eje	mm	80	80	80
Corsa verticale del piano <i>Course vertical de la table</i> Recorrido vertical de la mesa	mm	150	150	150
Battute registrabili <i>Butees réglables</i> Posiciones regulables	n.	6	6	6
Dimensioni del piano di lavoro <i>Dimensions de la table de travail</i> Dimensiones mesa de trabajo	mm	800x600	800x600	800x600
Max. distanza fra piano e mandrino <i>Distance max entre table et mandrin</i> Distancia máxima entre mesa y eje	mm	195	195	195
Velocità di rotazione del mandrino <i>Vitesses de rotation du mandrin</i> Velocidades del eje	g/1' t/1' r/1'	9000-18000	9000-18000	9000-18000
Potenza motore <i>Poids net</i> Peso neto	Kw (HP) Kw (CV) Kw (CV)	1,5/2,2 (2/3)	2,2/3 (3/4)	2,2/3 (3/4)



G800 - G900

FORATRICI
DEFONCEUSES
FRESEDORAS VERTICALES



G900 BASIC



Option Basic
Standard CE



G 800 BASIC

p 157



Dati tecnici

Données Techniques - Datos Técnicos

		G800	G900
Distanza fra albero e colonna Distance entre arbre et colonne Distancia entre eje y columna	mm	750	950
Corsa verticale del mandrino Course vertical du mandrin Recorrido vertical del eje	mm	100	100
Corsa verticale del piano Course vertical de la table Recorrido vertical de la mesa	mm	200	200
Battute registrabili Butees réglables Posiciones regulables	n.	6	6
Dimensioni del piano di lavoro Dimensions de la table de travail Dimensiones mesa de trabajo	mm	900x780	900x780
Max. distanza fra piano e mandrino Distance max entre table et mandrin Distancia máxima entre mesa y eje	mm	300	320
Velocità di rotazione del mandrino Vitesse de rotation du mandrin Velocidades del eje	g/1' v/1' r/1'	9000-18000	9000-18000
Potenza motore Poids net Peso neto	Kw (HP) Kw (CV) Kw (CV)	5/6 (3,7/4,5)	6/7,5 (4,5/5,5)

TENONATRICE A 4 ALBERI
TENONNEUSE AVEC 4 ARBRES
ESPIGADORA CON 4 EJES



CE

p 157



Dati tecnici

Données Techniques - Datos Técnicos

GT 4S

Gruppo sega / Groupe scie / Grupo sierra

Potenza motore sega / teste porta coltelli Puissance de moteur / Scie / Tête porte couteaux Potencia motor Sierra/Cabezales	HP (kW) CV (kW)	3 (2,2)
Ø lama / Ø de la lame / Ø disco	mm	250

Spostamento orizzontale lama Déplacement horizontal de la lame Desplazamiento horizontal disco	mm	40
--	----	----

Altezza max lavoro Hauteur maxi de travail Altura max de trabajo	mm	70
--	----	----

Teste porta coltelli / Tête porte-couteaux / Cabezales

Lunghezza utile Longeur utile Longitud útil	mm	100
---	----	-----

Ø testa portacoltelli Ø tête porte-couteaux Ø cabezal portacuchillas	mm	85
--	----	----

Distanza max-min fra le due teste Distance maxi-min entre les deux têtes Distancia max entre entre los dos cabezales	mm	70
--	----	----

Albero per tenonare Arbre à tenonner Eje para espigar

Ø albero / Ø de l'arbre / Ø eje	mm	40
---------------------------------	----	----

Lunghezza utile Longeur utile Longitud útil	mm	150
---	----	-----

Corsa orizzontale manuale albero Course horizontale manuelle arbre Recorrido horizontal manual eje	mm	70
--	----	----

Velocità di rotazione albero Vitesse de rotation de l'arbre Velocidad de rotación eje	g/1' t/1' v/1'	3000
---	----------------------	------

Potenza motore Puissance de moteur Potencia motor	HP (kW) CV (kW)	4 (3)
---	--------------------	-------

Ø utensile max Ø maxi outil Ø herramienta max	mm	300
---	----	-----

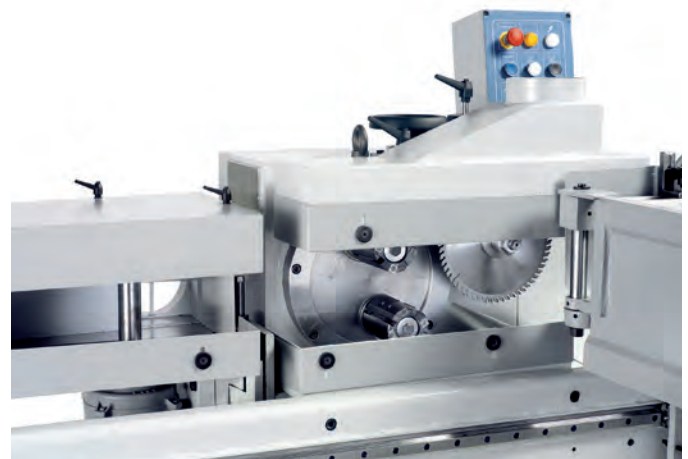



GAT 180

TENONATRICE A 2 ALBERI
TENONNEUSE AVEC 2 ARBRES
ESPIGADORA CON 2 EJES



CE

p 157 Dati tecnici <i>Données Techniques - Datos Tecnicos</i>		GAT 180	
Gruppo sega / Groupe scie / Grupo sierra			
Potenza motore <i>Puissance de moteur</i> Potencia motor	HP (kW) CV-----	4 (3)	
Ø lama / Ø de la lame / Ø disco	mm	400	
Spostamento orizzontale lama <i>Déplacement horizontal de la lame</i> Desplazamiento horizontal disco	mm	120	
Altezza max lavoro <i>Hauteur maxi de travail</i> Altura max de trabajo	mm	105 (145)* (165)*	
Carro per tenonare / Chariot à tenonner / Carro para espigar			
Corsa <i>Course</i> Recorrido	mm	1500	
Dimensioni <i>Dimensions</i> Medidas	mm	500x900	

Albero per tenonare Arbre à tenonner Eje para espigar		
Ø albero / Ø de l'arbre / Ø eje	mm	40
Lunghezza utile <i>Longueur utile</i> Longitud útil	mm	(220)* 170 (250)* (300)*
Corsa orizzontale manuale albero <i>Course horizontale manuelle arbre</i> Recorrido horizontal manual eje	mm	70
Velocità di rotazione albero <i>Vitesse de rotation de l'arbre</i> Velocidad de rotación eje	g/1' v/1' r/1'	3200
Corsa verticale albero <i>Course verticale arbre</i> Recorrido vertical eje	mm	90
Potenza motore <i>Puissance de moteur</i> Potencia motor	mm	7,5 (5,5)
Ø utensile max applicabile <i>Ø maxi outil</i> Ø herramienta max aplicable	mm	320

Option *

GAT 150/4



TENONATRICE A 4 ALBERI
TENONNEUSE AVEC 4 ARBRES
ESPIGADORA CON 4 EJES

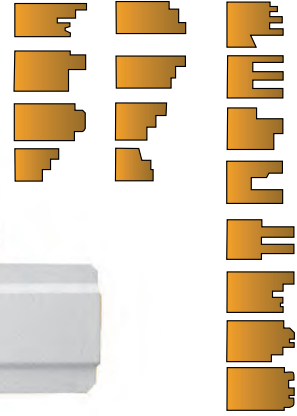

p 157



Dati tecnici

Données Techniques - Datos Tecnicos

GAT 150/4

Gruppo sega / Groupe scie / Grupo sierra		
Potenza motore Puissance de moteur Potencia motor	HP (kW) CV-----	3 (2,2)
Ø lama / Ø de la lame / Ø disco	mm	500
Spostamento orizzontale lama Déplacement horizontal de la lame Desplazamiento horizontal disco	mm	140
Altezza max lavoro Hauteur maxi de travail Altura max de trabajo	mm	125
Teste porta coltelli / Tête porte-couteaux / Cabezas portacuchillas		
Lunghezza utile Longeur utile Longitud útil	mm	150
Ø testa portacoltelli Ø tête porte-couteaux Ø cabezal portacuchillas	mm	200
Potenza motori (n°2) Puissance de moteurs (n°2) Potencia motores (n°2)	HP (kW) CV-----	3 (2,2)
Distanza max-min fra le due teste Distance maxi-min entre les deux têtes Distancia max entre entre los dos cabezas	mm	5÷125
Carro per tenonare / Chariot à tenonner / Carro para espigar		
Corsa Course Recorrido	mm	2000
Dimensioni Dimenions Medidas	mm	500x900

Albero per tenonare Arbre à tenonner Eje para espigar		
Ø albero / Ø de l'arbre / Ø eje	mm	40
Lunghezza utile Longeur utile Longitud útil	mm	170
Corsa orizzontale manuale albero Course horizontale manuelle arbre Recorrido horizontal manual eje	mm	70
Corsa verticale albero Course vertical arbre Recorrido vertical eje	mm	80
Velocità di rotazione albero Vitesse de rotation de l'arbre Velocidad de rotación eje	g/1' t/1' r/1'	3000
Potenza motore Puissance de moteur Potencia motor	Hp (Kw)	5,5 (4)
Ø utensile max applicabile Ø maxi outil Ø herramienta max aplicable	mm	350

Option *



GAL/E - GAL/P

CAVETTATRICI AUTOMATICHE PER PERSIANE
 MORTAISEUSES AUTOMATIQUES POUR PERSIENNES
 RANURADORAS DE PERSIANAS

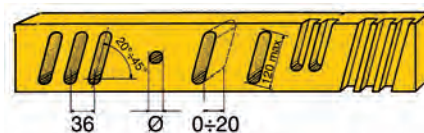

GAL/E BASIC

Con sistema di funzionamento meccanico
 Avec système de fonctionnement mécanique
 Con sistema de funcionamiento mecánico

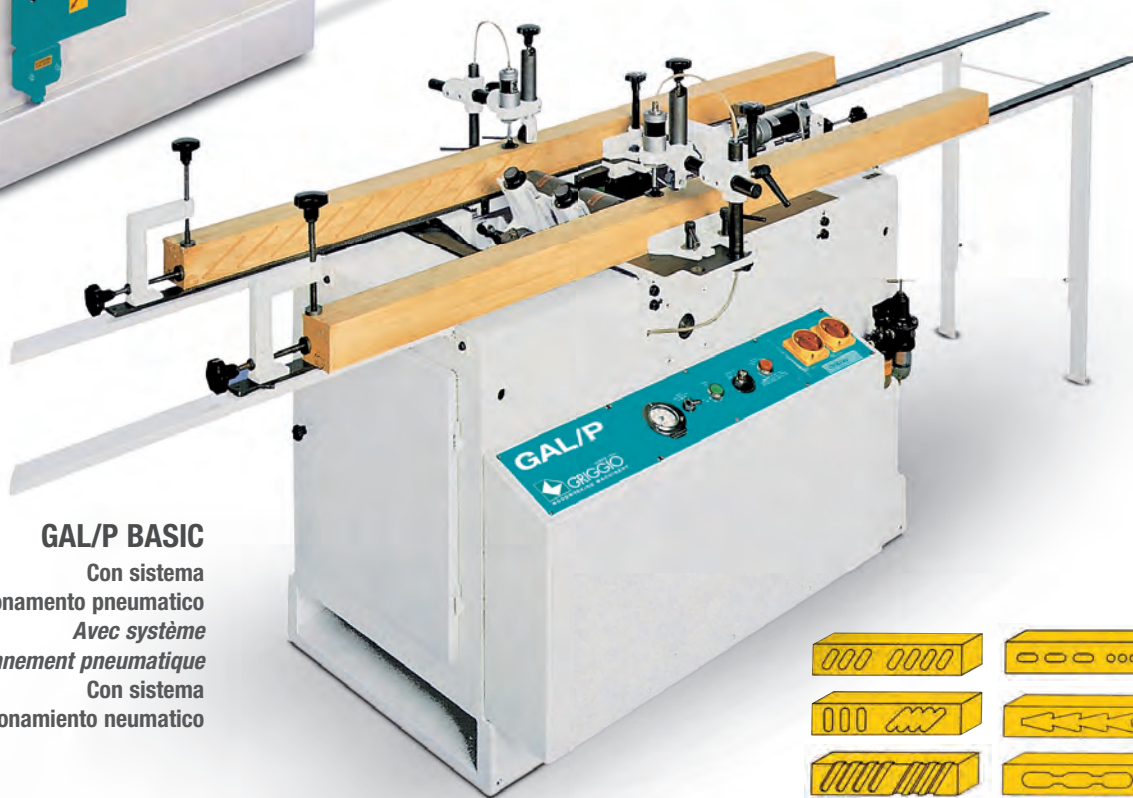

GAL/P BASIC

Con sistema di funzionamento pneumatico
 Avec système de fonctionnement pneumatique
 Con sistema de funcionamiento neumático

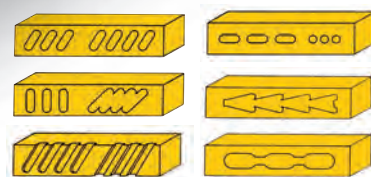

p 157

Dati tecnici

Données Techniques - Datos Técnicos

	GAL/E	GAL/P		GAL/E	GAL/P
Cave al minuto su 2 montanti Lumière par minute sur 2 montants Ranuras por minuto sobre 2 montantes	24	20	Lunghezza cremagliera Longueur crémaillère Longitud de la cremallera	mm 2800	2800
Inclinazione registrabile cava Inclination réglable de lumière Inclinación regulable	20°-45°	0° (oriz.) 90° (vert.)	Rotazione punta Rotation mèches Rotación brocas	g/1' v/1' r/1'	9600 12000
Profondità massima della cava Profondeur max. de la lumière Profundidad max. de la ranura	mm 20	25	Pressione di esercizio alimentata da compressore di 100 litri Pression de travail entraînée par un compresseur de 100 litres atm Presión de trabajo alimentada por un compresor de 100 lt	—	6-8 atm
Dimensione massima del montante Dimension max. du montant Dimensiones max. del montante	mm 100x110	100x120	Motore punta Moteur mèches Motor puntas	Kw (HP) Kw (CV)	2,2 (3) 1,1 (1,5)
Dimensione minima del montante Dimension min. du montant Dimensiones min. del montante	mm 20x40	20x40	Motore slitta Moteur patin Motor movimiento soporte	Kw (HP) Kw (CV)	— 0,8 (1)
Possibilità di esecuzione dei seguenti passi con cremagliera Possibilité d'effectuer avec la même crémaillère le pas ci-après Posibilidad de ejecución de los siguientes pasos con única cremallera	mm 36	6,5-13-19,5-26 32,5-39-45,5 52-58,5-65 71,5-78-84,5 91-97,5			

G281 - G450 - G550/S



CAVATRICI A CATENA / MORTAISEUSES À CHAÎNES / ESCOPLEADORAS DE CADENA



G 281

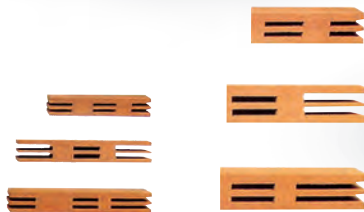

G 450

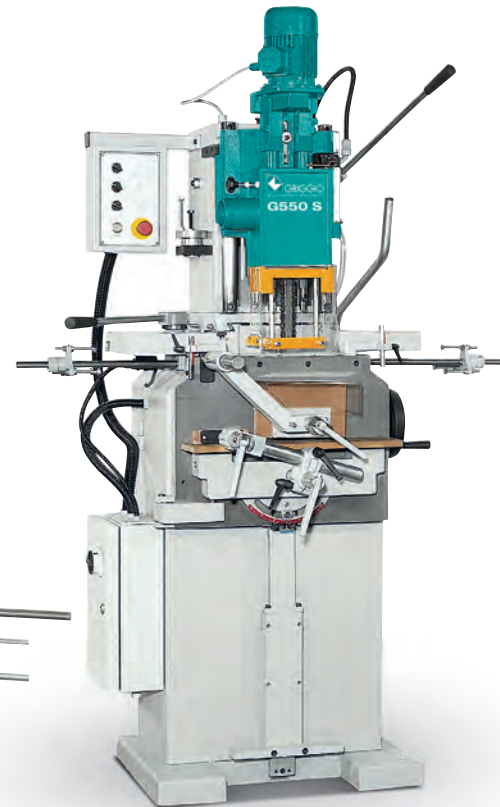

G 550/S



p 157 Dati tecnici Données Techniques - Datos Técnicos	G 281 G 450 G550/S			Dati tecnici Données Techniques - Datos Técnicos	G 550/S	
	Corsa verticale testa Course verticale de la tête Carrera vertical de la cabeza	mm	180		180	180
Corsa trasversale testa Course transversale de la tête Carrera transversal de la cabeza	mm	80	150	150	mm	85
Corsa longitudinale testa Course longitudinale de la tête Carrera longitudinal de la cabeza	mm	200	230	260	mm	70
Corsa verticale del piano lavoro Course verticale de la table de travail Carrera vertical de la mesa trabajo	mm	160	90	180	HP CV	1
Dimensione piano di lavoro Dimensions de la table de travail Dimensiones de la mesa de trabajo	mm	540x110	540x110	600x110	mm	55-105
Inclinazione piano lavoro Inclinaison table de travail Inclinación mesa trabajo	±	45°	45°	45°	mm	12x1
Rotazione testa Rotation de la tête Rotación de la cabeza	±	45°	45°	45°		
Max altezza porta Hauteur maxi de la porte Altura max de la puerta	mm	900	950	1050		
Potenza motore catena Puissance moteur chaîne Potencia motor cadena	KW(HP-CV)	1,5(2)	2,2(3)	2,2(3)		
				Potenza motore mandrini verticale Puissance moteur des mandrins verticaux Potencia motor mandriles verticales	HP	0,5
				Interasse mandrini verticali Distance entre-axes des mandrins verticaux Distancia entre mandriles verticales	mm	85
				Corsa verticale mandrini Tours des mandrins verticaux Carrera mandriles verticales	mm	70
				Potenza motore mandrini orizzontali Puissance moteur des mandrins horizontaux Potencia motor mandriles horizontales	HP CV	1
				Interasse mandrini orizzontali (Min.- Max.) Distance minimum - maximum de l'entre-axes des mandrins horizontaux Distancia minima - maxima entre mandriles horizontales	mm	55-105
				Ø Attacco frese Ø Queue des fraises Ø Mango herramientas	mm	12x1



GL 25 - GL 30

LEVIGATRICI A NASTRO
 PONCEUSE À BANDE
 LIJADORA DE BANDA

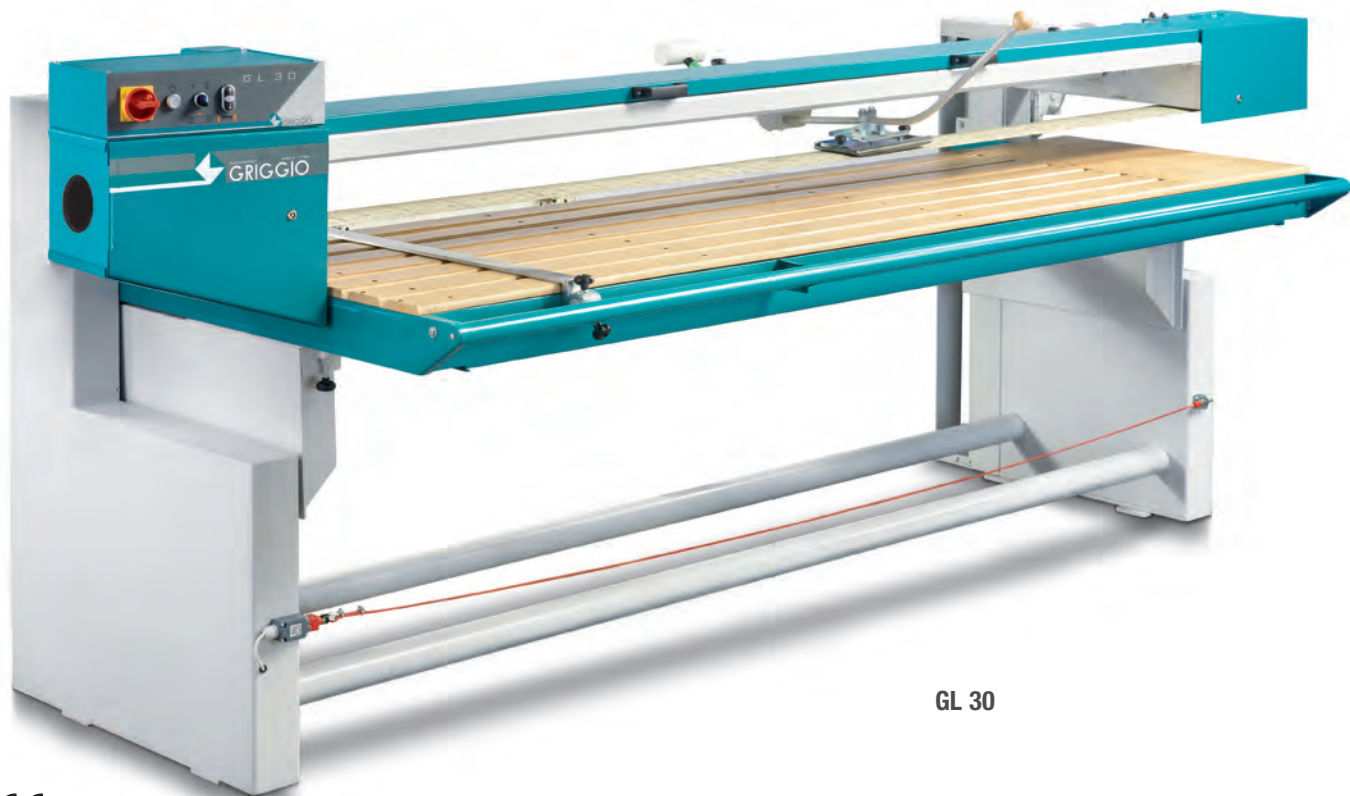

GL 30

CE

p 157

Dati tecnici

Données Techniques - Datos Tecnicos

		GL 25	GL 30
Dimensioni del piano di lavoro <i>Dimensions de la table de travail</i> Dimensiones mesa de trabajo	mm	2500x800	3000x800
Spostamento verticale del piano <i>Déplacement vertical de la table</i> Desplazamiento vertical de la mesa	mm	570	570
Motore principale a 2 velocità <i>Moteur principal à 2 vitesses</i> Motor principal a 2 velocidades	KW(HP) KW(CV)	2,2/3(3/4)	2,2/3(3/4)
Dimensioni del nastro abrasivo <i>Dimensions de la bande abrasive</i> Dimensiones de la cinta abrasiva	mm	6800x150	7800x150
Velocità del nastro <i>Vitesse de la bande</i> Velocidades de la cinta	m/sec mts/sec m/seg	17-35	17-35
Profondità utile collo d'oca <i>Profondeur utile du coi de cygne</i> Profundidad útil del doble codo	mm	700	700
Altezza utile collo d'oca <i>Hauteur utile du coi de cygne</i> Altura útil del doble codo	mm	250	250
Diametro puleggia <i>Diamètre de la poulie</i> Diámetro polea	mm	190	190
Potenza motore sollevamento <i>Puissance moteur relevage</i> Potencia motor subida	Kw	0,37	0,37



SPAZZOLATRICE MANUALE DI FINITURA BROSSEUSE MANUELLE DE FINISSAGE LIJADORA MANUAL DE ACABADO



S220

p 157



Dati tecnici

Données Techniques - Datos Técnicos

S 220

Spazzole Brosses Cepillo	mm	1x220
Dimensioni del piano di lavoro Dimensions de la table de travail Desplazamiento vertical de la mesa	mm	1200x600
Potenza motore Puissance moteur Potencia motor	Kw	1x0,55
Velocità spazzola Vitesse de la brosse Velocidad de cepillo	G/	150-1400
Inclinazione spazzola Inclinaison de la brosse Inclinación cepillo		+90 -90
Alimentazione elettrica Alimentation électrique alimentación electrica		380V 50Hz
Peso netto Poids net Peso neto	Kg	120

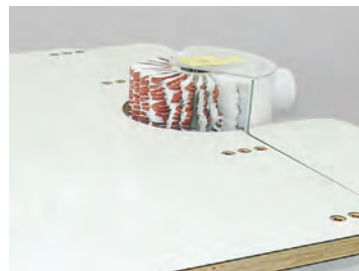



GL 150 - GL 200

LEVIGATRICE A NASTRO OSCILLANTE
 PONCEUSE À BANDE OSCILLANTE
 LIJADORA DE BANDA OSCILANTE



Option

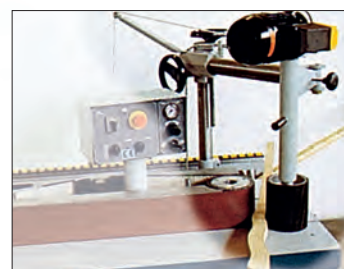

Option

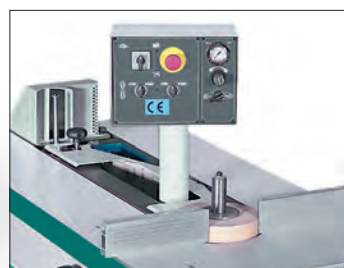

Option

p 157



Dati tecnici

Données Techniques - Datos Tecnicos

		GL 150	GL 200
Dimensioni piano lavoro fisso Dimensions table fixe Dimensiones de la mesa fija	mm	220x1440	220x1440
Dimensioni piano lavoro inclinabile Dimensions table inclinable Dimensiones de la mesa inclinable	mm	220x1440	220x1440
Inclinazione piano Inclination de la table Inclinacion de la mesa		0° - 45°	0° - 45°
Sviluppo nastro abrasivo Développement de la bande abrasive Medida cinta abrasiva	mm	150x2200	200x2200
Velocità del nastro Vitesse de la bande Velocidades de la cinta	m/sec mts/sec m/seg	12/8	12/8
Diametro rullo motorizzato Diamètre rouleau motorisé Diametro rodillo motorizado	mm	160	160
Diametro rullo condotto Diamètre rouleau conduit Diametro rodillo conducto	mm	80	80

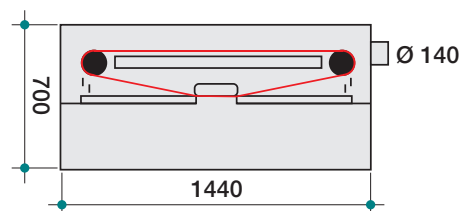

		GL 150	GL 200
Potenza motore traino nastro Puissance moteur avance bande Potencia motor cinta transportadora	KW (HP-CV)	1,8-2,5(2,5-3,5)	1,8-2,5(2,5-3,5)
Corsa oscillante Course oscillante Recorrido oscilante	mm	20	20
Spostamento verticale gruppo oscillante Déplacement vertical groupe oscillant Desplazamiento vertical grupo oscilante	mm	160	160
Pressione di esercizio Pression d'exercice Presion de trabajo	bar	6	6

GR 400-640-800-960-1250



SEGA RADIALE
SCIE RADIALE
SIERRA RADIAL



Option

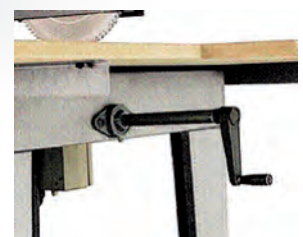

p 158



Dati tecnici

Données Techniques - Datos Técnicos

		GR400	GR640	GR800	GR960	GR1250
Lunghezza di taglio max Longueur maxi. de coupe Largo de corte máx	mm	15x440	20x630	20x790	20x930	20x1220
Altezza max di taglio Hauteur maxi. de coupe Altura máx. de corte	mm	85	100	100	100	100
Altezza max. taglio 45° Hauteur maxi. de coupe à 45° Altura max. corte 45°	mm	40	65	65	65	65
Dia. della lama Dia. de la lame Dia. del disco	mm	300	350/400	350/400	350/400	350/400
Potenza motore Puissance moteur Potencia motor	KW(HP-CV)	1,5 (2)	3 (4)	3 (4)	3 (4)	3 (4)



GSA

STRETTOIO OLEODINAMICO A BARRA UNICA
CADREUSE OLEODYNAMIQUE AVEC UNE BARRE
BANCO DE ARMAR CON UNA BARRA



Standard

CE

p 158

Dati tecnici

Données Techniques - Datos Tecnicos

GSA

Lunghezza utile di lavoro Longueur utile de travail Largo útil de trabajo	mm	3000
Larghezza utile di lavoro Largeur utile de travail Ancho útil de trabajo	mm	1700
Corsa verticale dei pistoni Course verticale des pistons Recorrido horizontal des pistones	mm	2x800 Ø 80
Corsa orizzontale dei pistoni Course horizontale des pistons Recorrido vertical des pistones	mm	2x1300 Ø 50
Pressione di spinta per ciascun cilindro verticale Pression de poussée pour chaque cylindre vertical Presión de empuje para cada cilindro vertical	Kg	3400
Pressione di spinta per ciascun cilindro orizzontale Pression de poussée pour chaque cylindre horizontal Presión de empuje para cada cilindro horizontal	Kg	8000
Potenza motore Puissance moteur Potencia motor	Kw (HP) Kw (CV) Kw (CV)	2,2(3)



Avviamento con possibilità di 2 cicli di lavorazione: 1° ciclo: automatico 2° ciclo: manuale

Démarrage avec choix de 2 cycles de travail: 1er cycle: automatique 2ème cycle: manuel

Activación con la posibilidad de 2 ciclos de elaboración: 1° Ciclo: automático 2° Ciclo: Manual

Option



Avviamento con comandi manuali a pulsantiera

Démarrage par commandes manuelles avec panneau des boutons

Activación con comandos manuales por medio de caja de pulsadores

Option

STRETTOIO OLEODINAMICO SEMIAUTOMATICO
 PRESSE OLEODYNAMIQUE SEMI-AUTOMATIQUE
 BANCO DE ARMAR SEMIAUTOMÁTICO

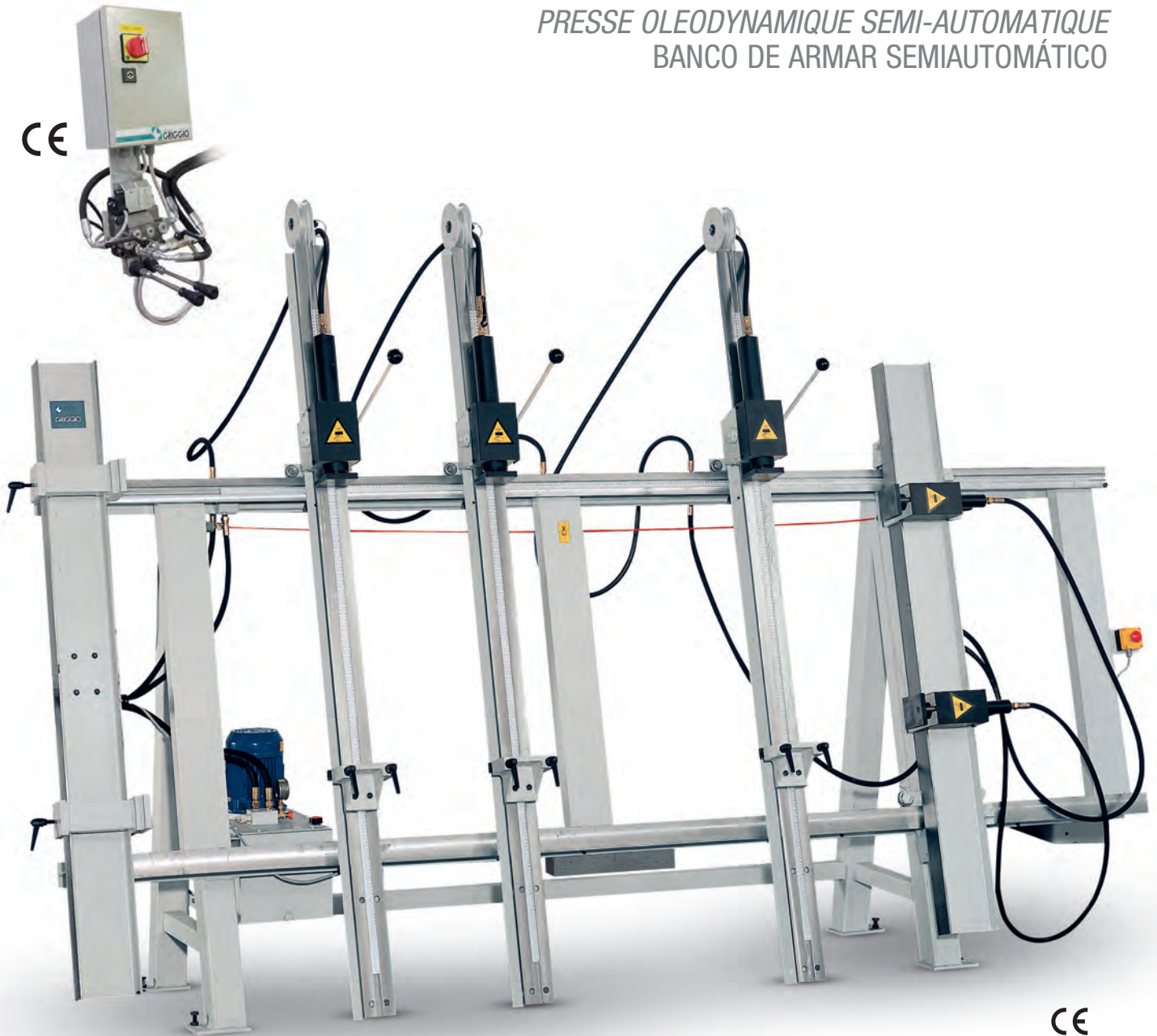

CE

p 158

Dati tecnici

Données Techniques - Datos Tecnicos

GS3

Lunghezza utile di lavoro Longueur utile de travail Largo útil de trabajo	mm	3050
Larghezza utile di lavoro Largeur utile de travail Ancho útil de trabajo	mm	1800
Pressione massima di lavoro Pression maximale de travail Presión max de trabajo	atm.	70
Pressione di spinta per ciascun cilindro verticale Pression de poussée pour chaque cylindre vertical Presión de empuje para cada cilindro vertical	Kg.	1660
Pressione di spinta per ciascun cilindro orizzontale Pression de poussée pour chaque cylindre horizontal Presión de empuje para cada cilindro horizontal	Kg.	670
Centralina motore Moteur cabinet de contrôle Centralina motor	Kw (HP)	1,5 (2)





GA - GM - GV

AVANZAMENTI AUTOMATICI
 ENTRAÎNEMENTS AUTOMATIQUES
 ALIMENTADORES AUTOMATICOS



GV3 - GV4
 Con variatore di velocità
 Avec variateur de vitesse
 Con variador de velocidad

GM - GA
 Con cambio manuale e automatico della velocità
 Avec changement manuel et automatique des vitesses
 Con cambio manual y automatico de las velocidades

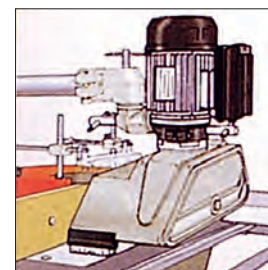
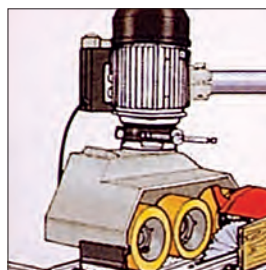
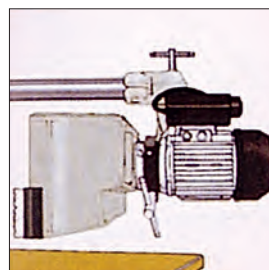
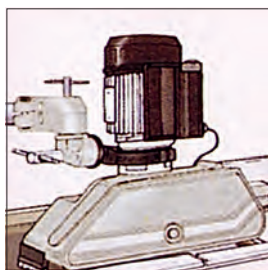

p 158

Dati tecnici
 Données Techniques - Datos Técnicos

		GM4/34	GA4/38	GA8/48	GA6/68	GV3	GV4
Rulli Rouleaux Rodillos	n°	3	3	4	6	3	4
Dia. rulli Dia. rouleaux Dia. rodillos	mm	120x60	120x60	120x60	120x60	120x60	120x60
Velocità di avanzamento con inversione Vitesse d'avan. avec inverseur de marche velocidad de avance con inversor	m/1'	4-8-11-22	2-4-5-6-11 13-16-33	2-4-5-6-11 13-16-33	2-4-5-6-11 13-16-33	3-18	3-18
Potenza motore Puissance du moteur Potencia motor	KW(HP-CV)	0,7/1	0,7/1	0,7/1	0,7/1	0,75(1)	0,75(1)

GA 630 - GA 850



AFFILATRICE AUTOMATICA
 AFFÛTEUSE DE COUTEAUX AUTOMATIQUE
 AFILADORA AUTOMÁTICA DE CHUCHILLAS



CE

p 158



Dati tecnici

Données Techniques - Datos Tecnicos

		GA 630	GA 850
Massima lunghezza da affilare contemporaneamente Maxime longueur à affûter en même temps Maximo largo de afilar contemporaneamente	mm	650	850
Potenza motore mola Puissance du moteur porte meule Potencia motor muela	KW(HP) KW(CV)	0,75(1)	0,75(1)
Giri motore porta mola Tours du moteur porte meule Velocidad de rotacion motor muela	g/1' t/1' r/1'	2800	2800
Mola tazza cilindrica Meule du type à tasse Medidas muela	mm	127x45x16	127x45x16
Max. coltelli da affilare (4 contemporaneamente) Max. couteaux d'affûter (jusqu'à 4) Max. cuchillas afilables (hasta 4 contemporaneamente)	n°	4	4



Movimento testa con cremagliera.
 Mouvement tête avec crémaillère.
 Movimiento cabezal con cremallera.



GM 104S - GM 104E

AFFILATRICI A MOLA AUTOMATICHE CON STRADATRICE
 AFFÛTEUSES À MEULE AUTOMATIQUES AVEC AVOYEUSE
 AFILADORAS AUTOMÁTICAS CON ENTRAMADOR

G 5 - 30
 G 10 - 40
 G 20 - 60

SALDATRICE / SOUDEUSE / SOLDADORA



GM 104 S

p 158



Dati tecnici

Données Techniques - Datos Tecnicos

		GM 104S	GM 104E
Passo min.-max denti lame nastro e circolari Écartement min.-maxi entre dents scie à ruban et circulaire Paso min.-max dientes sierras de cintas y circular	mm	5 - 30	5 - 30
Larghezza max. della lama Largeur maxi de la scie à ruban Largo de la sierra de cinta	mm	70	70
Min.-max dia. sega circolare Min.-maxi dia. scie circulaire Min.-max dia. del disco	mm	110-600	110-600
Motore mola Moteur meule Motor muela	KW	0,20	0,20
Motore Moteur Motor	KW	0,20	0,20
Denti affilati al 1' Dents affûtées par 1' Dientes afilados por 1'	n°	70	70
Dia. della mola Dia. de la meule Dia. de la muela	mm	152	152

GA U5

AFFILATRICE MANUALE UNIVERSALE AFFÛTEUSE MANUELLE UNIVERSELLE AFILADORA MANUAL UNIVERSAL

p 158 Dati tecnici Données Techniques - Datos Tecnicos		GA U5
Corsa max rettifica Course maxi rectifiée Largo máximo a rectificar	mm	200
Corsa max trasversale Course maxi transversal Recorrido transversal	mm	240
Corsa max. verticale Course maxi verticale Recorrido vertical max	mm	110
Altezza asse divisore Hauteur axe diviseur Altura de eje divisor	mm	220
Angolo rotazione divisore Angle rotation diviseur Angulo de rotación del divisor		360°
Angolo rotazione motore Angle rotation moteur Angulo de rotación motor		360°
Coltelli pialla max Couteaux rabot maxi Largo máximo de cuchillas	mm	600x100 (option)
Ø max. frese Ø maxi outils Ø máximo fresas	mm	120x400
Ø max. mole Ø maxi meules Ø máximo de la muela	mm	100÷200
Lama circolare Ø max. Lame circulaire Ø maximum Disco circular Ø max	mm	650 (option)



GA U5

Affilatura frese
Affûteuse fraises
Afiladura fresas



Option



Affilatura punte (option)
Affûteuse mèches (option)
Afiladura puntas (a pedido)



Affilatura coltelli (option)
Affûteuse couteaux (option)
Afiladura cuchillas (a pedido)



Affilatura lame (option)
Affûteuse lames (option)
Afiladura discos (a pedido)

GA 600

AFFILATRICE MANUALE PER LAME CIRCOLARI AFFÛTEUSE MANUELLE POUR LAMES CIRCULAIRES AFILADORA MANUAL PARA DISCOS Y FRESAS

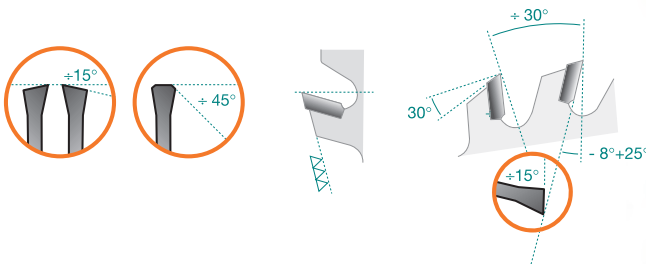

GA 600

p 158 Dati tecnici Données Techniques - Datos Tecnicos		GA 600
Lama min-max Lame minimum-maximum Disco min-max	mm	100÷600
Foro sega circolare Alesage scie circul. Agujero hojas circ.	mm	20
Diametro mola Diamètre de la meule Diamètre de la muela	mm	150
Foro mola Alesage meule Agujero de la piedra	mm	20
Motore mola Moteur meule Motor de la piedra	Kw (HP) Kw (CV)	0,18 (0,25)



Option



Macchine Speciali
Machines Spéciales
Máquinas Especiales

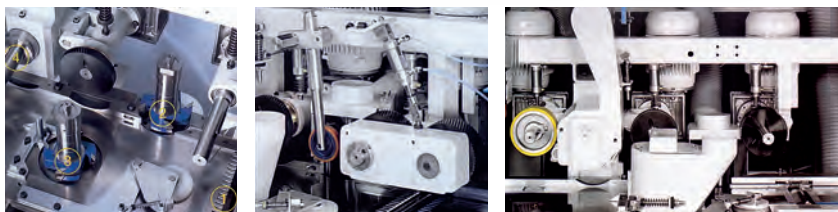

G18Q - G22Q

PIALLATRICE RADRIZZATRICE / CORROYEUSE
CEPILLADORA DE 4 CARAS

Rulli con motoriduttore indipendente, per una maggiore potenza di traino. Diam. rulli 140 mm. Rullo folle sul piano in uscita

Rouleaux d'avance avec motoreducteur indépendant pour une majeure puissance d'avance. Rouleaux diam. 140 mm. Rouleau sur la table de sortie.

Rodillo de arrastre con motoreductor independiente, para una potencia mas grande de arrastre. Ruedas de diam. 140 mm. Rodillo libre sobre la mesa en salida

2° e 3° albero toupie con utensile diam. min. 120 mm, diam. max. 140 mm., h. 130 mm.

Possibilità di posizionare l'utensile 10 mm sotto il piano di lavoro.

2° et 3° arbre toupie avec outil diam. mini 120 mm, diam. maxi 140 mm H. 130 mm possibilité de positionner l'outil 10 mm sous la table de travail.

2° y 3° eje tupi con herramienta diam. min. 120 mm, diam. max. 140 mm., h. 130 mm.

con posibilidad de posicionar la herramienta 10 mm. bajo la mesa de trabajo.

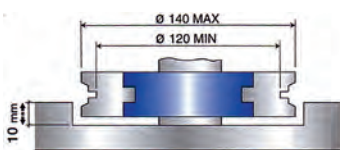

Possibilità di profilare i lati verticali (toupie) con utensili: diam. min. 120 mm, diam. max. 140 mm

Possibilité de profiler les côtés verticaux (toupie) avec outils diam. mini 120 mm., diam. maxi 140 mm.

Possibilidad de perfilar los lados verticales (tupi) con herramientas: diam. min. 120 mm., diam. max. 140 mm.



1° albero pialla e 4° albero spessore utensile diam. 125 mm. -h. 190 mm. Coppia di cuscinetti precaricati, lato utensile per una maggiore durata e rigidità del mandrino.

1° arbre degau et 4° arbre rabot outil diam. 125 mm. h. 190 mm. Couple de roulements prechargés, côté outil pour une majeure durée et rigidité du mandrin

1° eje cepillo y 4° eje regrueso herramienta diam. 125 mm., h. 190 mm. Pareja de cojinetes precargados, lado herramienta, para una mayor durada y carga del mandrin.

p 159

Dati tecnici

Données Techniques - Datos Tecnicos

G 22 Q

Sezione max. di lavoro Section max. de travail Seccion max. de trabajo	mm	220x120
Sezione min. di lavoro Section min. de travail Seccion min. de trabajo	mm	8x5
Lunghezza minima del pezzo (con pre pialla) Longeur min. du bois avec pré-dégau Largo min. de la pieza con pre-cepillo	mm	380
Capacità max. di piallatura Prise de bois maxi Capacidad max de cepillar	mm	10
Lunghezza del piano di entrata Longeur de la table d'entrée Largo de la mesa de entrada	mm	2000
Dia teste portacoltelli Dia. de les têtes Dia. de los cabezales	mm	125x190 (1°-4°) 125x130 (2°-3°)
Velocità di traino Vitesse d'avance Velocidad de arrastre	m/1'	8
Dia. rulli di traino n° 3 Dia. rouleaux d'avance n° 3 Dia. rodillos de arrastre n° 3	mm	140
Motori 1°-4° albero Moteurs 1°-4° arbre Motores 1°-4° eje	KW(HP-CV)	2x 4(5,5)
Motore 2°-3° albero Moteur 2°-3° arbre Motor 2°-3° eje	KW(HP-CV)	1x 5,5(7,5)
Motore traino Moteur avance Motor de arrastre	KW(HP-CV)	1,65(2,25)



G 230/4 - G 230/5U

SCORNICIATRICI AUTOMATICHE
CORROYEUSES AUTOMATIQUES
MOLDURERAS AUTOMÁTICAS

Schneider
Electric

Telemecanique

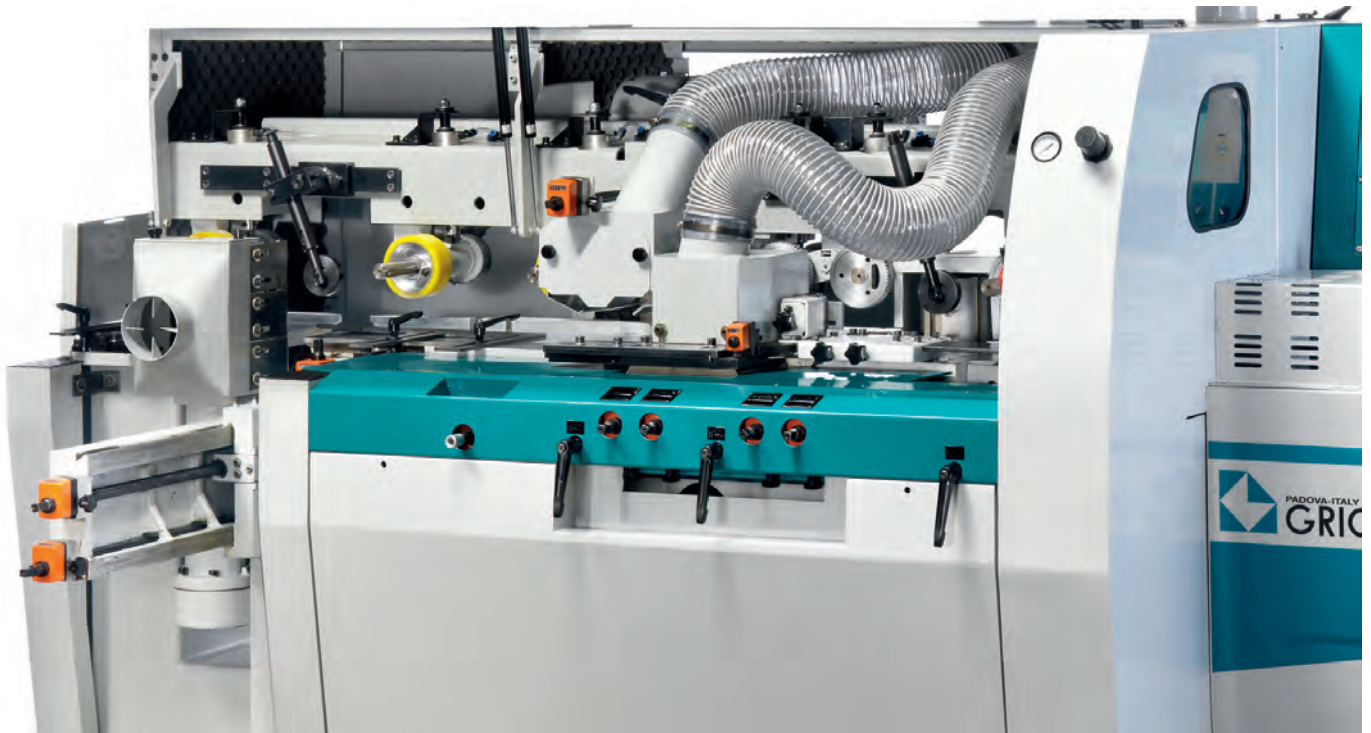

G 230/5U

360°

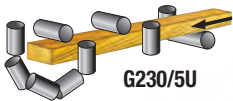

G230/5U

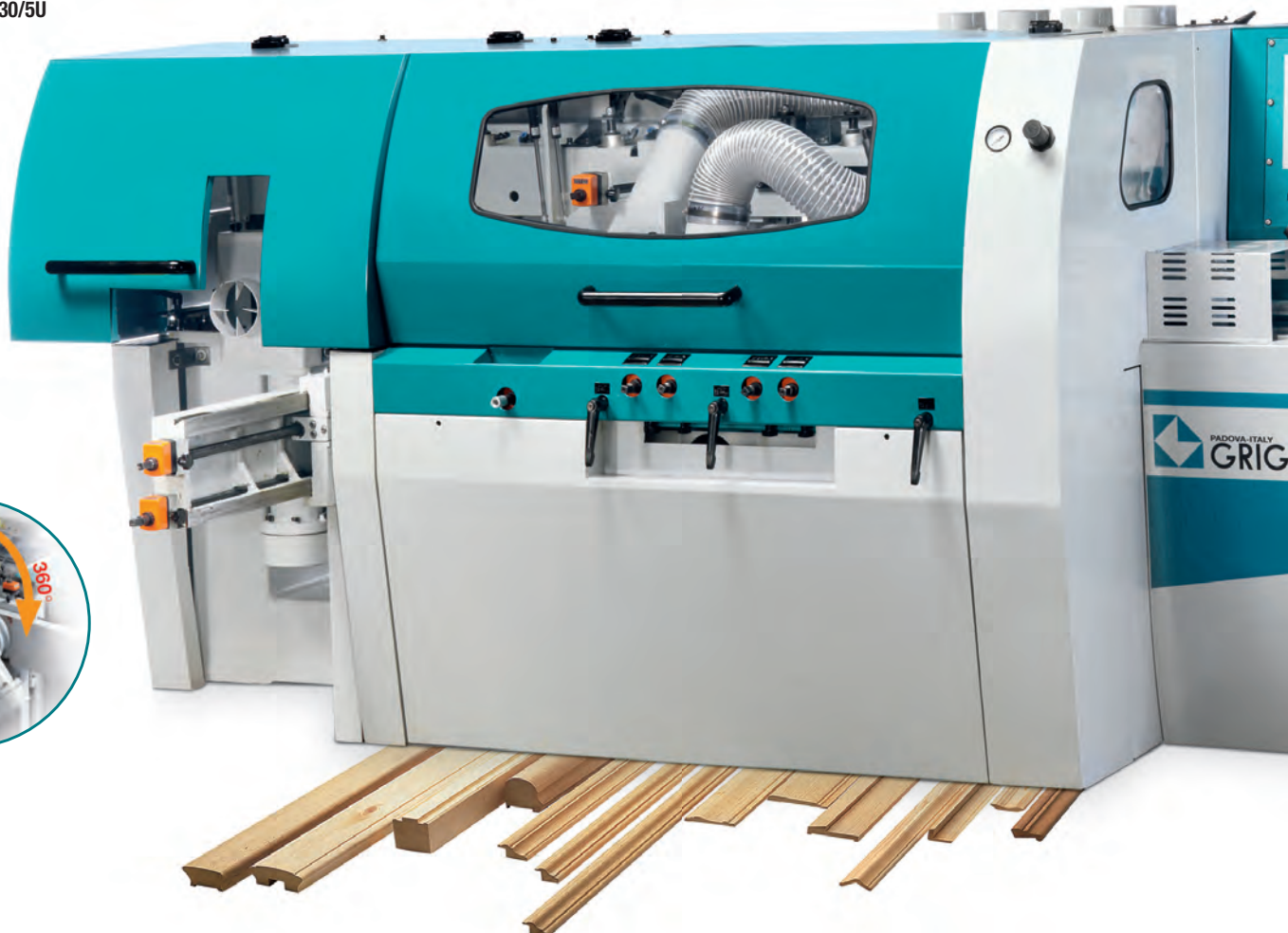



p 159

Dati tecnici

Données Techniques - Datos Tecnicos

		G 230/4	G 230/5U
Sezione max. di lavoro Section max. de travail Sección max. de trabajo	mm	230x120	230x120
Sezione min. di lavoro Section min. de travail Sección min. de de trabajo	mm	23x8	23x8
Lunghezza minima del pezzo (con pre pialla) Longeur min. du bois avec pré-dégau Largo min. de la pieza con pre-cepillo	mm	480	480
Capacità max. di piallatura Prise de bois maxi Capacidad max de cepillar	mm	10	10
Lunghezza del piano di entrata Longeur de la table d'entrée Longitud de la mesa de entrada	mm	2200	2200
Dia. teste portacoltelli Dia. de les tete Dia. de los cabezales	mm	120	120
Velocità di traino Vitesse d'avance Velocidad de arastre	m/1'	6-12	6-12
Dia. rulli di traino Dia. rouleaux d'avance Dia. rodillos de arastre	mm	120	120
Motore 1°-2°-3° albero Moterur 1°-2°-3° arbre Motor 1°-2°-3° eje	KW(HP-CV)	7,5 (Kw 5,5)	7,5 (Kw 5,5)
Motore 4° albero Moterur 4° arbre Motor 4° eje	KW(HP-CV)	10 (Kw 7,5)	10 (Kw 7,5)
Motore 5° albero universale a 360° Moterur 5° arbre universel à 360° Motor 5° eje universal a 360°	KW(HP)	—	5,5 (Kw 4)

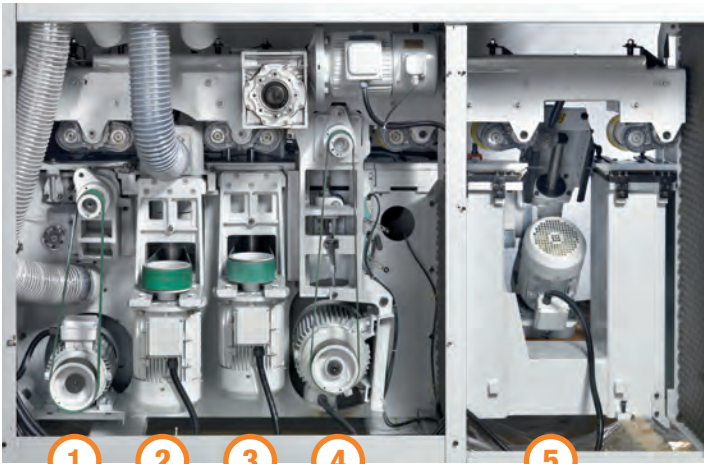

- 4-5 motori indipendenti
- 4-5 moteurs indépendants
- 4-5 motores individuales

Standard

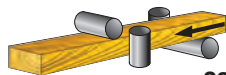

G230/4

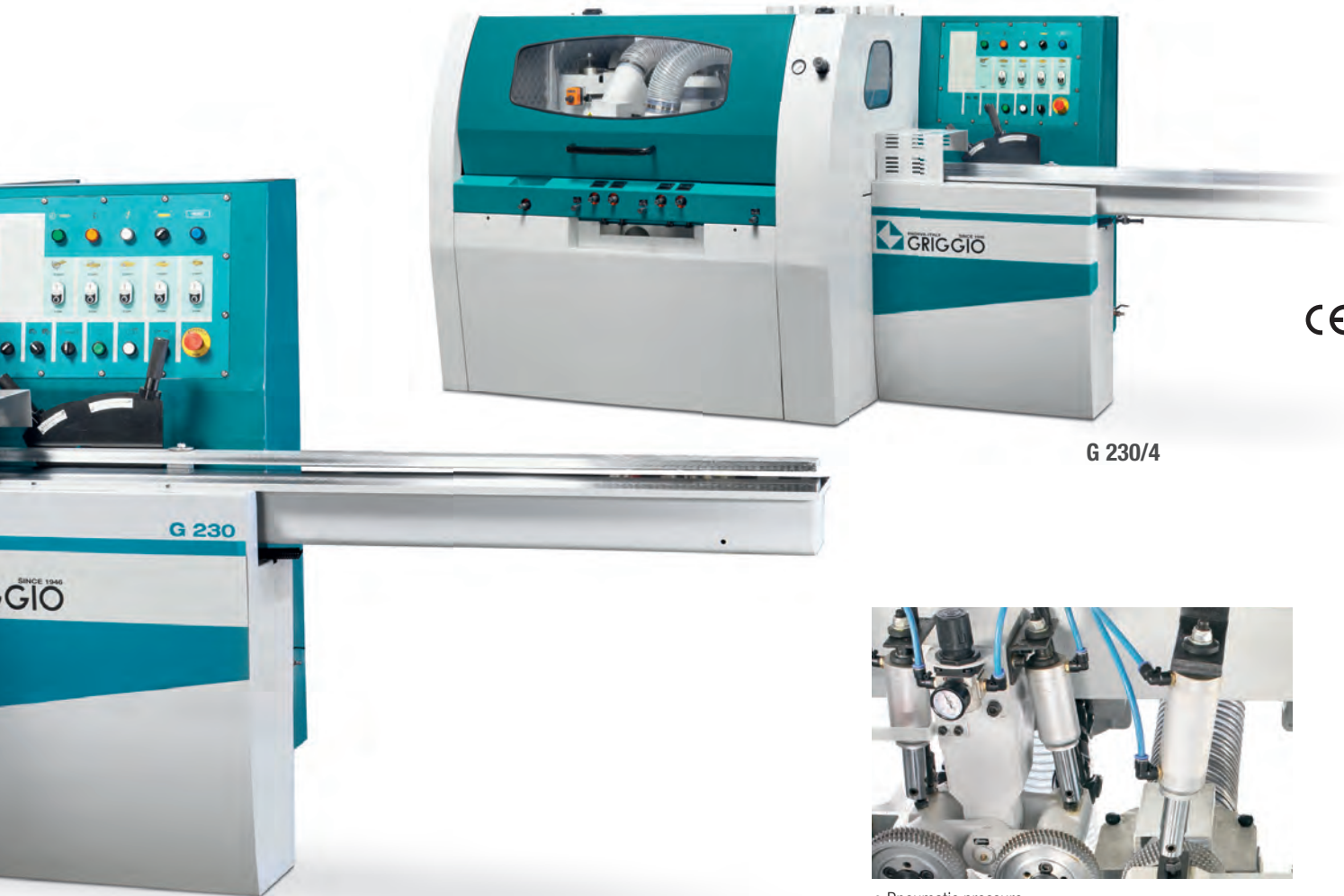

G 230/4

G 230/5U

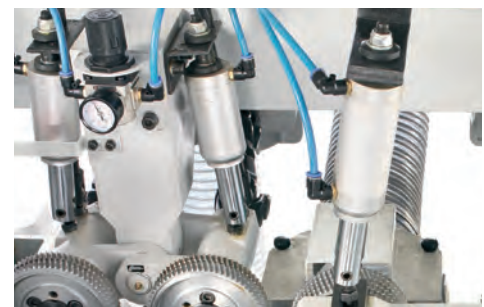

- Pneumatic pressure
- Pneumatischer Druck
- Пневматические прижимы

Standard

G240-4 G240-5/5U G240-6/6U G240/7U

SCORNICIATRICI AUTOMATICHE
CORROYEUSES AUTOMATIQUES
MOLDURERAS AUTOMÁTICAS

ABB

Telemecanique



G 240 /6U

CE

p 159



Dati tecnici

Données Techniques - Datos Tecnicos

G240-4 G240-5/5U
G240-6/6U G240 7U

Max. - min larghezza di lavoro Min-Max. largeur de travail Min- Max. anchura de trabajo	mm	20-240
Max. - min. altezza di lavoro Min-Max. hauteur de travail Min- Max. altura de trabajo	mm	8-160
Lunghezza piano entrata Longueur table d'entrée Anchura mesa entrada	mm	2000 (G240/4 - 5/5U/6U) 2400 (G240/6 - 7U)
Min. lunghezza di lavoro Longueur mini de travail Anchura min. de trabajo	mm	250
Spostamento max 2° e 3° albero sotto il piano Baissement maxi du 2ème et 3ème sous la table Max. desplazamiento del 2° y 3° eje bajo la mesa	mm	40
Spostamento 4° albero con movimento orizzontale per profilare Déplacement du 4ème arbre avec mouvement horizontal pour profiler Desplazamiento 4° eje a perfilar con movimiento horizontal	mm	45
Velocità di traino con variatore Vitesse d'avance avec variateur Velocidad de arrastre con variador	m/1'	6÷30
Velocità alberi portautensili Tours des arbres des porte outils Velocidades de rotacion eje porta herramientas	g/1' r/1'	6000
Potenza motori 1°-2°-3° albero Puissance moteur 1°-2°-3° arbre Potencia motores del 1°-2°-3° eje	(Kw) HP CV	5,5 (7,5)
Potenza motori 4°-5°-6° albero Puissance moteur 4°-5°-6° arbre Potencia motores del 4°-5°-6° eje	(Kw) HP CV	7,5 (10)
Potenza motore albero universale 360° Puissance moteur - arbre universal 360° Potencia motore eje universal 360°	(Kw) HP CV	5,5(7,5)
Ø utensili 1° albero Ø des outils 1er arbre Ø herramientas para 1° eje	mm	110-145
Ø utensili 2°-3°-4°-5°-6°-7° albero Ø des outils 2-3°-4°-5°-6°-7° arbre Ø herramientas para 2°-3°-4°-5°-6°-7° eje	mm	110-180



Standard

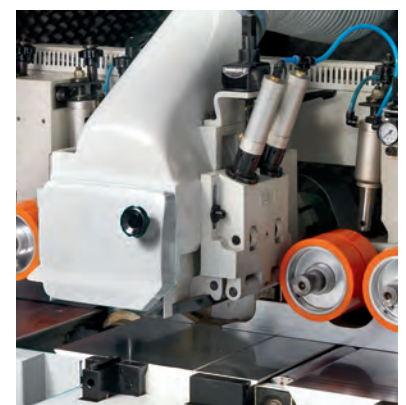

Standard

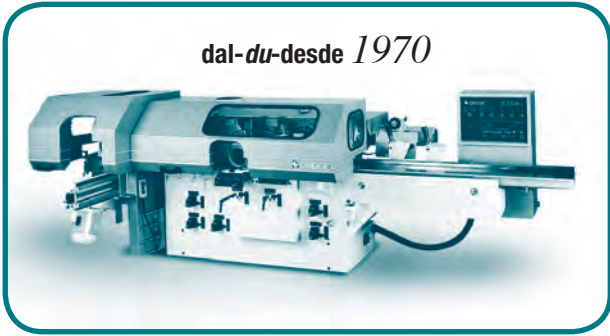
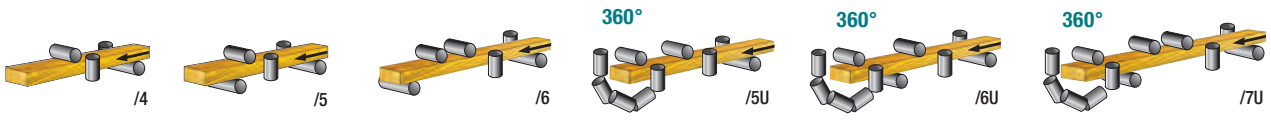

Standard

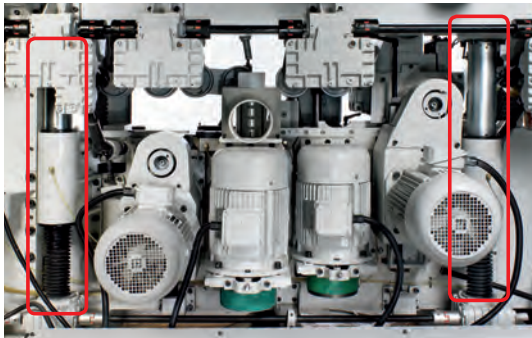

Standard

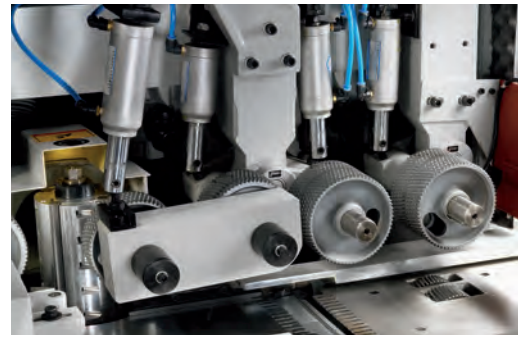

Standard



CE



C 300 - C350

SEGA CIRCOLARE MULTILAME AUTOMATICA
 SCIES CIRCULAIRE MULTILAMES AUTOMATIQUE
 SIERRA CIRCULAR MULTIPLE AUTOMÁTICA



C300



C350

p 159

Dati tecnici

Données Techniques - Datos Técnicos

		C 300	C 350
Spessore max. di taglio <i>Epaisseur max. de coupe</i> Max. espesor de corte	mm	110	120
Lunghezza min. dei pezzi (su richiesta) <i>Longueur min. des pièces (sur demande)</i> Largo mín. de las piezas (a pedido)	mm	600(300)	600(450)
Dia. lame: min.-max. <i>Dia. lames: min.-maxi</i> Dia. disco: min.-max.	mm	250-350x70	250-350x70
Distanza max. fra le due lame esterne <i>Distance maxi entre 2 lames externes</i> Distancia máx. entre los dos discos exteriores	mm	300	350
Larghezza tappeto di traino <i>Largueur tapis de avance</i> Ancho de la cinta de arastre	mm	300	350
Velocità avanzamento tappeto <i>Vitesses d'avance tapis</i> Velocidad arastre cinta	mt/1'	3/24	7/30
Potenza motore <i>Puissance moteur</i> Potencia motor	KW (HP) KW (CV) KW (CV)	22-29-36 (30-40-50)	36-44-55 (50-60-75)



FORATRICE MULTIPLA A 10 TESTE
PERCEUSE MULTIBROCHE À 10 TÊTES
TALADRO MULTIPLE A 10 CABEZALES

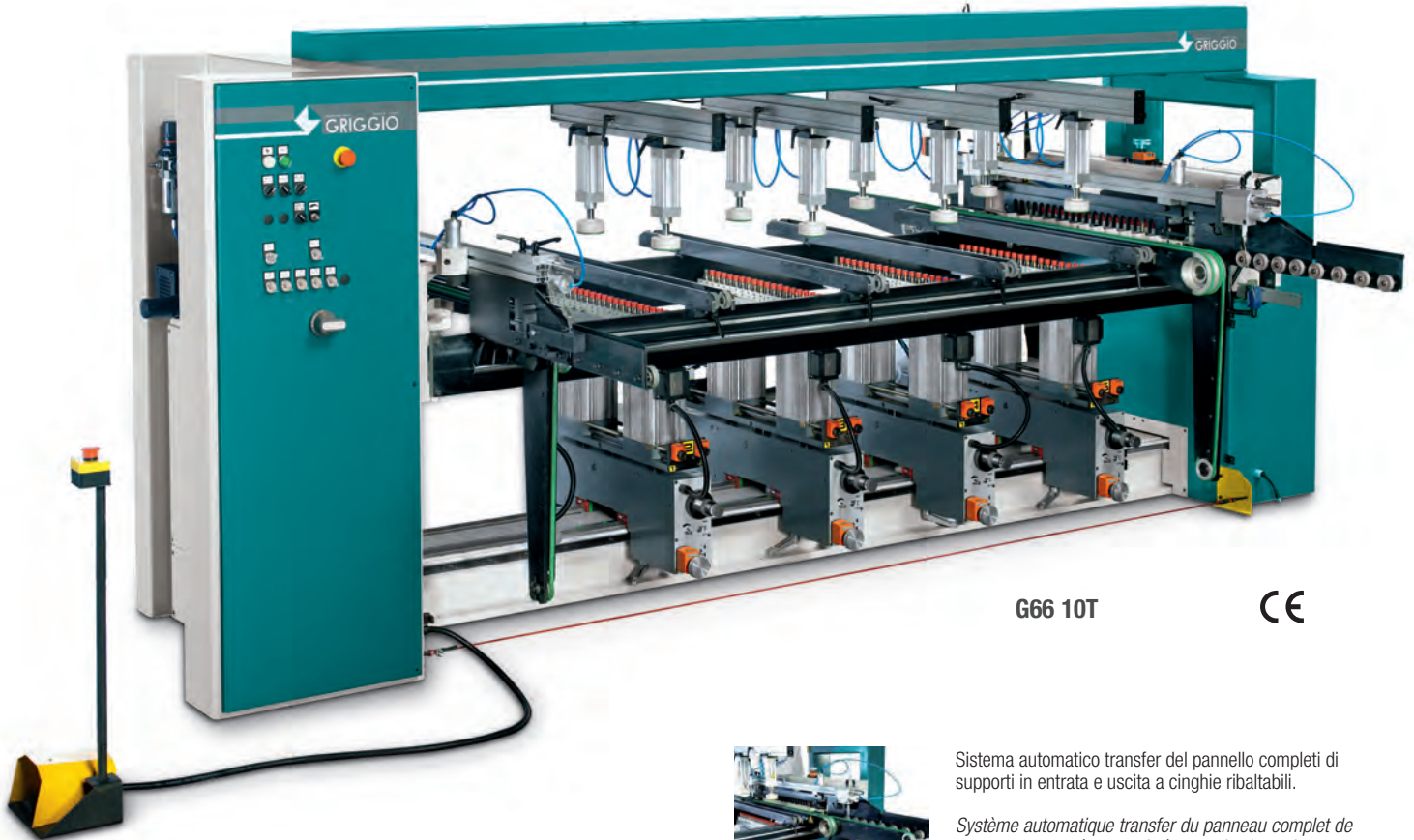

G66 10T

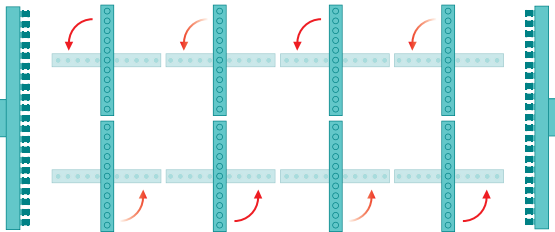

Sistema automatico transfer del pannello completi di supporti in entrata e uscita a cinghie ribaltabili.

Système automatique transfer du panneau complet de supports en entrée et sortie à courroies basculantes.

Sistema automatico transferencia del panel completo de soportes en entrada y salida a correas rebaltables.



Gruppo forante orizzontale sinistro completa di testa a 21 mandrini.

Group perçage horizontal gauche complet de tête à 21 mandrins.

Grupo perforante horizontal izquierdo completo de cabezal a 21 mandriles.



Gruppo forante destro scorrevole completo di testa a 21 mandrini.

Group perçage droite coulissant complet de tête à 21 mandrins.

Grupo perforante derecho que se desliza completo de cabezal a 21 mandriles.



Gruppi verticali scorrevoli su guide prismatiche a ricircolo di sfere completo di 2 teste da 11 mandrini cadauno girevoli da 0° a 90°.

Group verticales coulissant sur guide prismatique à recircule de sphères complet de 2 tête de 11 mandrins chaque tournant de 0° à 90°.

Grupos verticales que se desliza en guías prismáticas a recirculo de bolas completo de 2 cabezales de 11 mandriles cada giratorios de 0° a 90°.

p 159



Dati tecnici

Données Techniques - Datos Técnicos

G66 10T

Interasse fra ogni mandrino <i>Entre-axe entre chaque mandrins</i> Distancia entre cada mandril	mm	32
Spessore massimo pannelli <i>Max. épaisseur des panneaux</i> Max. espesor de los paneles	mm	60
Profondità massima di foratura <i>Max. profondeur de perçage</i> Profundidad max. a taladrar	mm	70
Velocità rotazione mandrini <i>Vitesse de rotation des mandrins</i> Velocidad rotación mandriles	g/l' t/1' r/1'	2800
Mandrini del gruppo orizzontale <i>Mandrins du groupe horizontal</i> Mandriles del grupo horizontal	n°	2 x 21
Mandrini dei gruppi verticali <i>Mandrins des groupes verticaux</i> Mandriles de los grupos verticales	n°	4 x (11x11)
Distanza min-max. tra le teste verticali <i>Largeur min-maxi entre les têtes verticales</i> Distancia min-max. entre los cabezales verticales	mm	140
Potenza motori teste orizzontali <i>Puissance moteurs têtes horizontales</i> Potencia motores cabezales horizontales	KW(HP-CV)	1,5 x 2 (2)
Potenza motori teste verticali <i>Puissance moteurs têtes verticales</i> Potencia motores cabezales verticales	KW(HP-CV)	1,1 x 8 (1,5)



GC65 - GC95 - GC110

LEVIGATRICI-CALIBRATRICI
PONCEUSES-CALIBREUSES
LIJADORAS-CALIBRADORAS



CE

GC 110



Ø 150

RT

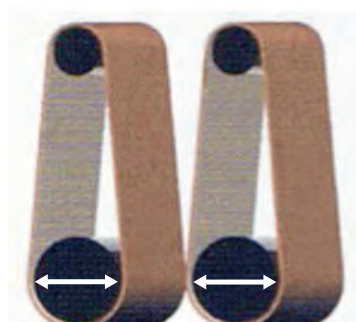

Ø 150 Ø 150

2RR



Ø 150 Ø 150

2RRT

GRIT-SET ELETTRONICO un sistema ottimale per memorizzare automaticamente i diversi gradi di asportazione, sia in fase di calibratura che di levigatura. Facilita così, e non poco, il lavoro di regolazione dei rulli, velocizzando sempre più e con più precisione le lavorazioni.

GRIT-SET ELECTRONIQUE excellent système permettant de mémoriser automatiquement les différents degrés de retrait, à la fois de la phase de calibrage et de ponçage. Il facilite considérablement le travail de réglage des rouleaux en rendant les usinages de plus en plus rapides et précis.

GRIT-SET ELECTRÓNICO un excelente sistema para memorizar automáticamente los diferentes grados de remoción, tanto en fase calibrado como de lijado, que facilita considerablemente la operación de regulación de los rodillos y agiliza cada vez más y con mayor precisión el trabajo.

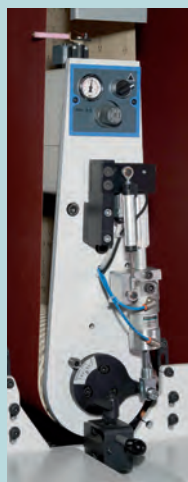

Ø 150 Standard
Ø 180
Ø 220
Option

Ø 180
Ø 180
Option



Sistema di sollevamento del piano: sistema di sollevamento del piano con 4 pistoni, integrato da un ulteriore sistema di tenuta del piano sui 4 lati, appositamente lavorati e rettificati. Questo sistema assicura rigidità e precisione di lavoro.

Système de levage de la table: système innovant de levage de la table de transport assuré par quatre pistons et complété par un système de retenue de la table sur les quatre côtés du bâti, spécialement usinés et rectifiés. Ce système assure une rigidité et une précision de travail uniques dans le secteur des calibreuses-ponceuses.

Sistema de elevación de la mesa: Innovador sistema de elevación de la mesa transportadora asegurado por cuatro pistones e integrado por un ulterior sistema de sujeción de la mesa en los cuatro lados, especialmente trabajados y rectificadas, de la base. Este sistema asegura una rigidez y precisión de trabajo única en el sector de las calibreadoras-lijadoras.



Sistema di regolazione dell'asportazione con: esclusione automatica dei rulli da quadro comando grit-set a 6 posizioni per la selezione delle differenti grane dei nastri

Option

Système de réglage de l'épaisseur à enlever avec: exclusion pneumatique des rouleaux depuis le panneau de commande grit-set mécanique à 6 positions pour la sélection des rubans

Option

Sistema de regulación de la remoción con: exclusión neumática de los rodillos desde el cuadro de mandos grit-set mecánico a 6 posiciones por el posicionamiento según el grano abrasivo

Option



Standard

- Variatore velocità tappeto 4/20 m/1'
- Variateur de vitesse tapis 4/20 m/1'
- Variador de velocidad patin 4/20 m/1'



Standard

- Posizionatore automatico del piano
- Positionneur automatique de la table
- Posicionador automático de la mesa

p 159



Dati tecnici

Données Techniques - Datos Tecnicos

		GC65 1RT	GC65 2RR	GC65 2RRT	GC95 1RT	GC95 2RR	GC95 2RRT	GC110 1RT	GC110 2RR	GC110 2RRT
Larghezza utile di lavoro Largeur utile de travail Anchura útil de trabajo	mm	650	650	650	650	950	950	1100	1100	1100
Altezza max. di lavoro Hauteur max. de travail Altura máx. de trabajo	mm	160-3	160-3	160-3	160-3	160-3	160-3	160-3	160-3	160-3
Lunghezza min. di lavoro Longueur min. de travail Longitud mínima de trabajo	mm	370	280	370	350	200	350	350	200	350
Larghezza tampone Largeur tampon Anchura patin	mm	50	-	50	50	-	50	50	-	50
Sviluppo nastri abrasivi Développement des bandes abrasives Desarrollo bandas abrasivas	mm	2150	2150	2150	2150	2150	2150	2150	2150	2150
Velocità nastri abrasivi Vitesse des bandes abrasives Velocidad bandas abrasivas	m/1'	18	18	18	18	18	18	18	18	18
Diametro rullo Diamètre du rouleau Diámetro del rodillo	mm	150	150	150	150	150/150	150/150	150/150	150/150	150/150
Durezza rulli Dureté du rouleau Dureza del rodillo	sh	90	90/45	90/45	90/45	90/45	90/45	90/45	90/45	90/45
Velocità di avanzamento tappeto Vitesse d'avance tapis Velocidad de la cinta transportadora	m/1'	4/20	4/20	4/20	4/20	4/20	4/20	4/20	4/20	4/20
Potenza motore nastro Puissance moteur bande Potencia motor banda	Kw (HP-CV)	7,5(10)	7,5(10)	7,5(10)	7,5(10)	7,5(10)	7,5(10)	11(15)	11(15)	11(15)
Pressione di esercizio Pression d'exercice Presión de ejercicio	Atm	6	6	6	6	6	6	6	6	6
Consumo aria compressa Consommation d'air comprimé Consumo aire comprimido	m3/h	30	30	30	30	30	30	30	30	30
Capacità impianto di aspirazione Capacité inst. d'aspiration Capacidad aspiración	Amp	2000	3000	3000	3000	3000	3000	3000	3000	3000



Option

- Centraggio automatico del tappeto
- Centrage automatique du tapis
- Centrado automático de la banda transportadora



Option

- Rulliera estraibile
- Rouleaux extractible
- Grupo de rodillo estraible

GI 1100 - GI 1300

LEVIGATRICI-CALIBRATRICI
PONCEUSES-CALIBREUSES
LIJADORAS-CALIBRADORAS



Option



CE

GI 1100
GI 1300



Ø 220
2 RT

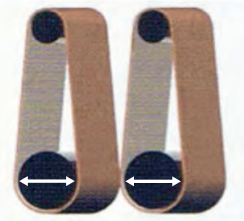

Ø 220 Ø 220
2RR



Ø 180 Ø 180
2RRT

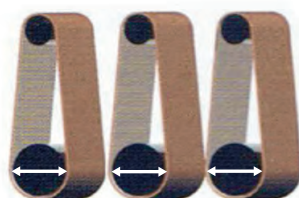

Ø 180 Ø 220 Ø 320
RRR

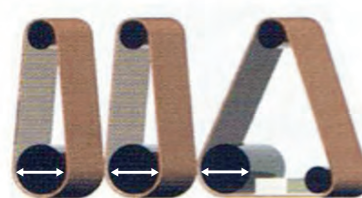

Ø 180 Ø 180 Ø 180
RRRT



Sistema di sollevamento del piano: sistema di sollevamento del piano con 4 pistoni, integrato da un ulteriore sistema di tenuta del piano sui 4 lati, appositamente lavorati e rettificati. Questo sistema assicura rigidità e precisione di lavoro.

Systeme de levage de la table: système innovant de levage de la table de transport assuré par quatre pistons et complété par un système de retenue de la table sur les quatre côtés du bâti, spécialement usinés et rectifiés. Ce système assure une rigidité et une précision de travail uniques dans le secteur des calibreuses-ponceuses.

Sistema de elevación de la mesa: Innovador sistema de elevación de la mesa transportadora asegurado por cuatro pistones e integrado por un ulterior sistema de sujeción de la mesa en los cuatro lados, especialmente trabajados y rectificadas, de la base. Este sistema asegura una rigidez y precisión de trabajo única en el sector de las calibreuses-lijadoras.



Sistema di regolazione dell'asportazione con: esclusione automatica dei rulli da quadro comando grit-set a 6 posizioni per la selezione delle differenti grane dei nastri
Standard

Système de réglage de l'épaisseur à enlever avec: exclusion pneumatique des rouleaux depuis le panneau de commande grit-set mécanique à 6 positions pour la sélection des rubans
Standard

Sistema de regulación de la remoción con: exclusión neumática de los rodillos desde el cuadro de mandos grit-set mecánico a 6 posiciones por el posicionamiento según el grano abrasivo
Standard

GRIT-SET ELETTRONICO un sistema ottimale per memorizzare automaticamente i diversi gradi di asportazione, sia in fase di calibratura che di levigatura. Facilita così, e non poco, il lavoro di regolazione dei rulli, velocizzando sempre più e con più precisione le lavorazioni.

GRIT-SET ELECTRONIQUE excellent système permettant de mémoriser automatiquement les différents degrés de retrait, à la fois de la phase de calibrage et de ponçage. Il facilite considérablement le travail de réglage des rouleaux en rendant les usinages de plus en plus rapides et précise.

GRIT-SET ELECTRÓNICO un excelente sistema para memorizar automáticamente los diferentes grados de remoción, tanto en fase calibrado como de lijado, que facilita considerablemente la operación de regulación de los rodillos y agiliza cada vez más y con mayor precisión el trabajo.

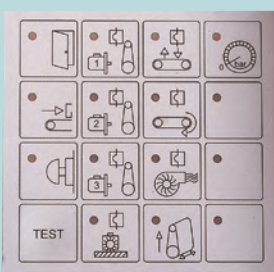

Check control pannello di controllo a led luminosi segnalanti eventuali anomalie

Check control sur le clavier à touches, signal avec voyant indiquant là où l'anomalie s'est produite

Check control en la botonera señal con diodo luminoso donde se ha verificado el inconveniente

Option: GI -2NRT/2RR/2RRT

Standard: GI -RRR/RRRT



Option

- Rulliera estraibile
- Rouleaux extractible
- Grupo de rodillo estraible



Standard

- Variatore velocità tappeto 4/20 m/1'
- Variateur de vitesse tapis 4/20 m/1'
- Variador de velocidad patin 4/20 m/1'

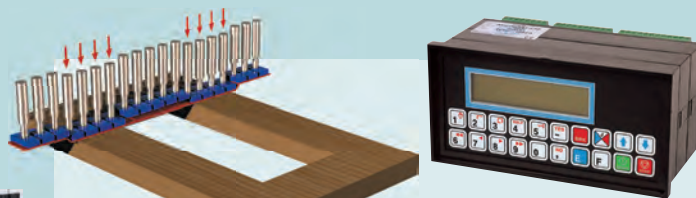

TAMPONE ELETTRONICO SEZIONATO (OPTION)
PATIN ELECTRONICO SECTIONNE
PATIN ELECTRONICO A SECTORES

Questo tipo di tampone consente di levigare in maniera uniforme superfici con variazioni di spessore (concavi, convessi, sfenestrati etc.) e questo in quanto una barra di lettura iniziale legge la forma geometrica del pannello e sollecita, tramite il programmatore elettronico, la corretta temporizzazione e relativa pressione dei relativi settori. Consente inoltre la possibilità di lavorare più pezzi contemporaneamente. Nel caso di pannelli non perfettamente piani, ottimi risultati si ottengono preselezionando uno o due settori, sia in più che in meno, rispetto a quelli sollecitati in entrata.

Ce type de patin permet de poncer les surfaces de manière uniforme en cas de changements d'épaisseur (concaves, convexes, panneaux etc.). En effet, une barre de lecture initiale lit la forme géométrique du panneau et sollicite, par le biais d'un programmeur électronique, la temporisation exacte et la pression voulue sur chaque secteur. Il est ainsi possible de travailler sur plusieurs pièces simultanément. En présence de panneaux qui ne sont pas parfaitement plans, d'excellents résultats peuvent être obtenus en sélectionnant un ou deux secteurs, en plus ou en moins par rapport à ceux qui sont sollicités à l'entrée.

Este tipo de tampón permite lijar de modo uniforme superficies con variaciones de espesor (paneles cóncavos, convexos, con aberturas, etc.). Esto es debido a una barra de lectura inicial que lee la forma geométrica del panel y solicita, por medio del programador electrónico, la correcta temporización y relativa presión de los correspondientes sectores. Asimismo permite trabajar varias piezas a la vez. En el caso de paneles no perfectamente planos, se obtienen excelentes resultados preseleccionando uno o dos sectores de más o de menos respecto a los sollicitados en entrada.

Option



Standard

- Centraggio automatico del tappeto (optional)
- Centrage automatique du tapis
- Centrado automático de la banda trasportadora



Standard

- Posizionatore automatico del piano
- Positionneur automatique de la table
- Posicionador automático de la mesa

p 160

Dati tecnici

Données Techniques - Datos Técnicos

		GI1100 GI1300 2RT	GI1100 GI1300 2RR	GI1100 GI1300 2RRT	GI1100 GI1300 RRR	GI1100 GI1300 RRRT
Larghezza utile di lavoro Largeur utile de travail Anchura útil de trabajo	mm	1100 1350	1100 1350	1100 1350	1100 1350	1100 1350
Altezza max. di lavoro Hauteur max. de travail Altura máx. de trabajo	mm	160-3	160-3	160-3	160-3	160-3
Lunghezza min. di lavoro Longueur min. de travail Longitud mínima de trabajo	mm	370	280	370	280	370
Larghezza tampone Largeur tampon Anchura patin	mm	50	-	50	-	50
Sviluppo nastri abrasivi Développement des bandes abrasives Desarrollo bandas abrasivas	mm	2150	2150	2150	2150	2150
Velocità nastri abrasivi Vitesse des bandes abrasives Velocidad bandas abrasivas	m/1'	18	18	18	18	18
Diametro rullo Diamètre du rouleau Diámetro del rodillo	mm	220	220/220	180/180	180/220 320	180/180 180
Durezza rulli Dureté du rouleau Dureza del rodillo	sh	90	90/45	90/45	90/45	90/45
Velocità di avanzamento tappeto Vitesse d'avance tapis Velocidad de la cinta transportadora	m/1'	4,5/9	4,5/9	4,5/9	4,5/9	4,5/9
Potenza motore nastro Puissance moteur bande Potencia motor banda	Kw (HP-CV)	15(20)	15(20)	15(20)	1° 15(20) 2°-3° 15(20)	1° 15(20) 2°-3° 15(20)



R 1300 / S 1300

SPAZZOLATRICE-RUSTICATRICE
 BROSSEUSE À EFFECTS RUSTIQUES BROSSEUSE
 LIJADORA PARA SACAR LA VETA-LIJADORA AUTOMÁTICA



CE

S1300/2RS

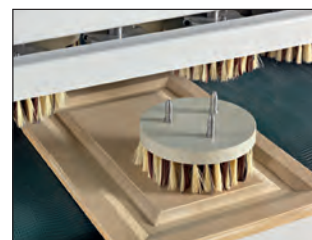

option

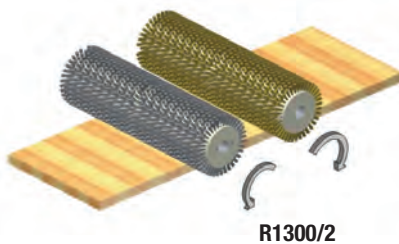

R1300/2

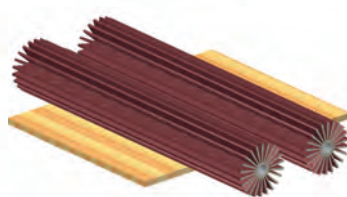

S1300/2

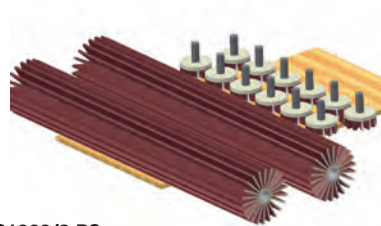

S1300/2 RS

p 160

Dati tecnici

Données Techniques - Datos Tecnicos

		R 1300/2 S 1300/2	S 1300/2RS
Superficie di lavoro Superficie de travail des brosses Area de trabajo cepillos	mm	1300	1300
Altezza massima di lavoro Hauteur maximum de travail Altura max de trabajo	mm	170 110	110
Motore spazzola Moteur brosse Motor cepillo	Kw	2x6,2 2x3,3	2x3,3
Potenza moto-variante tappeto Force mouvement variateur tapis Potencia moto-variador patin	Kw	0,55	0,55
Velocità di avanzamento Vitesse d'avancement Velocidad de avance	mt/min	3/10	3/10
Ø Spazzola Ø Brosse Ø Cepillo	mm	300 350	350
Ø aspirazione Ø aspiration Ø aspiracion	mm	4x140	4x140
Peso netto / Poids net / Peso neto	Kg	980	1550



SL 220
 Option
 Spazzole laterali
 Brosses latérales
 Cepillos laterales

S 200/3 - S200/4



SPAZZOLATRICI PER PROFILI
BROSSEUSES POUR PROFILS
LIJADORA PARA PERFILES



CE

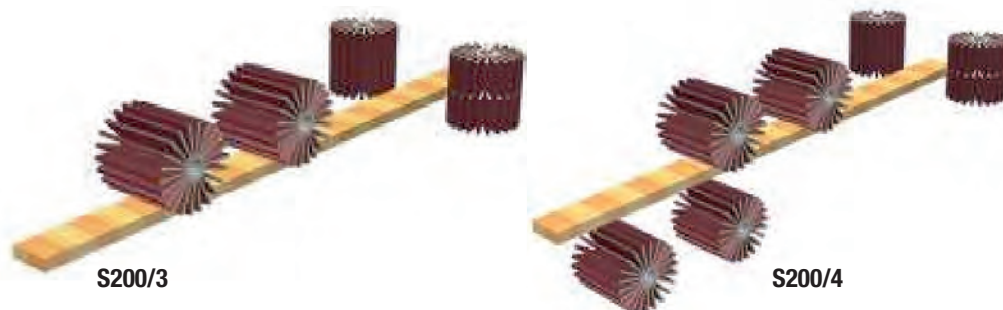
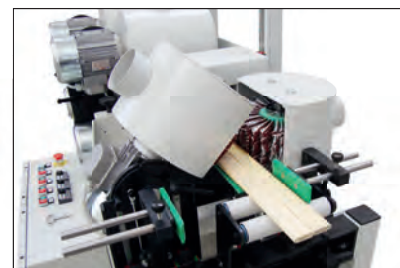
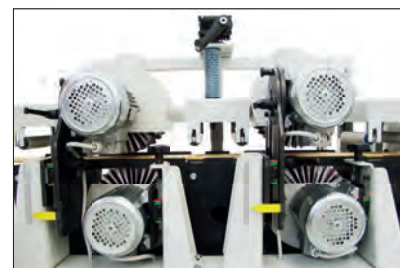

S200/3

S200/4

p 160



Dati tecnici

Données Techniques - Datos Técnicos

		S200/3	S200/4
Teste Têtes Cabezas	n°	4	6
Superficie di lavoro Superficie de travail des brosses Area de trabajo cepillos	mm	200	200
Altezza massima di lavoro Hauteur maximum de travail Altura max de trabajo	mm	150	150
Ø Spazzola Ø Brosse Ø Cepillo	mm	4 x 280	4 x 280
Motore spazzola Moteur brosse Motor cepillo	Kw	4 x 0,75	6 x 0,75
Velocità di avanzamento Vitesse d'avancement Velocidad de avance	m/1'	200-900	200-900
Inverter motori spazzole Inverter moteurs brosses Inverter motores cepillos	Kw	0,75 x 4	0,75 x 6
Variatore velocità tappeto Variateur de vitesse du tapis Variador delocidad patin	Kw	1,5 x 2	1,5 x 3

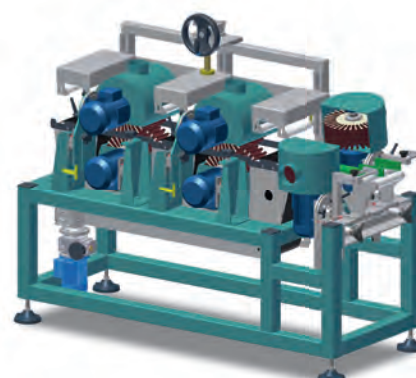

R 300 - R 600 - R 800

RUSTICATRICI / BROSSEUSES A EFFET RUSTIQUE / LIJADORAS PARA SACAR LA VETA



R 300/2
R 600/2
R 800/2



R 300/4



R 300/1



Tipi di spazzole che possono essere usati
Types de brosses à utiliser
Tipo de cepillos que se pueden utilizar

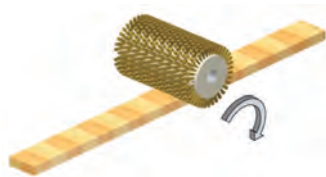

R300/1

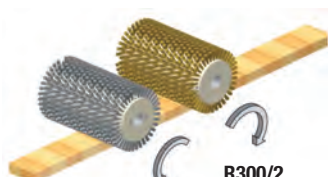

R300/2
R600/2
R800/2

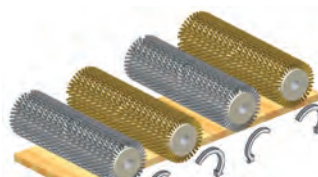

R300/4
R600/4

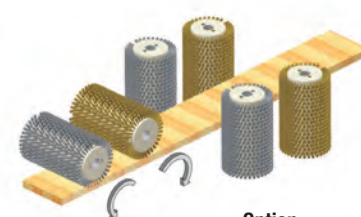

Option

p 160

Dati tecnici

Données Techniques - Datos Técnicos

		R 300/1	R 300/2	R 300/4	R 600/2	R 600/4	R 800/2
Superficie di lavoro Superficie de travail des brosses Area de trabajo cepillos	mm	300	300	300	600	600	800
Altezza massima di lavoro Hauteur maximum de travail Altura max de trabajo	mm	300 110	300 110	300 110	300 110	300 110	300 110
Motore spazzola Moteur brosse Motor cepillo	Kw	1x3	2x3	4x3	2x4	4x4	2x5,5
Potenza moto-variabile tappeto Force mouvement variable tapis Potencia moto-variador patin	Kw	0,18	0,18	0,18	0,37	0,37	0,37
Velocità di avanzamento Vitesse d'avancement Velocidad de avance	mt/min	3/10	3/10	3/10	3/10	3/10	3/10
Ø Spazzola Ø Brosse Ø Cepillo	mm	200 220	200 220	200 220	200 250	200 250	200 250
Ø aspirazione Ø aspiration Ø aspiracion	mm	1x120	2x120	4x120	2x140	4x140	2x140
Peso netto / Poids net / Peso neto	Kg	330	440	830	750	1420	830

RL 200

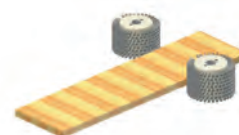

RL 200 Option

Gruppo laterale
Brosses latérales
Cepillos laterales

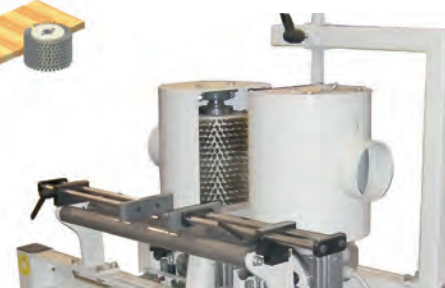

S 300 - S 600 - S 800



SPAZZOLATRICI / BROSSEUSES / LIJADORAS AUTOMATICAS



S 300/2
S 600/2
S 800/2

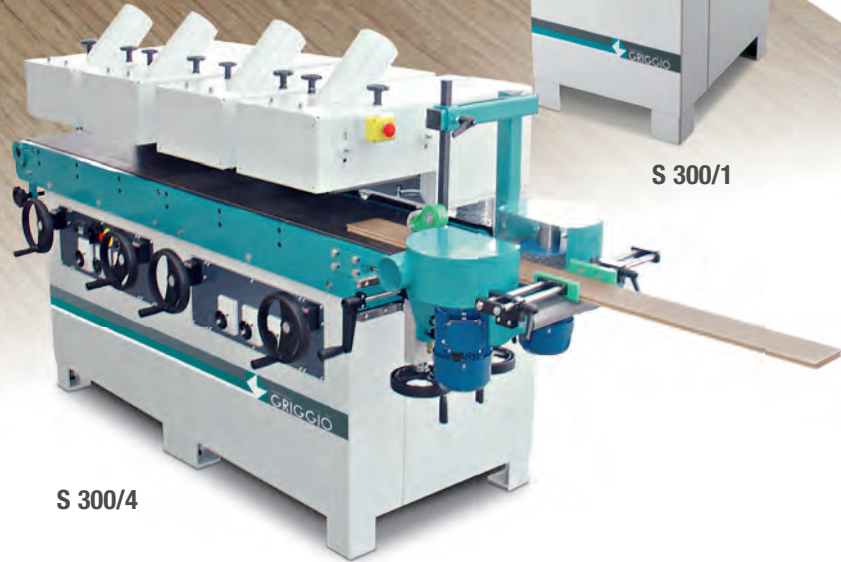

S 300/4



S 300/1



Tipi di spazzole che possono essere usati
Types de brosses à utiliser
Tipo de cepillos que se pueden utilizar

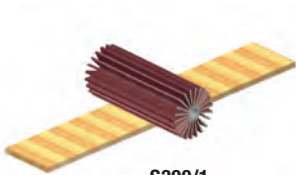

S300/1

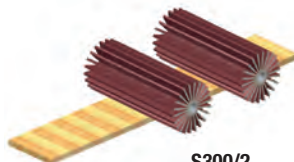

S300/2
S600/2
S800/2

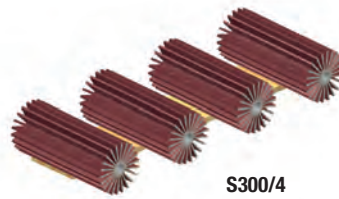

S300/4
S600/4



p 160

Dati tecnici

Données Techniques - Datos Tecnicos

		S 300/1	S 300/2	S 300/4	S 600/2	S 600/4	S 800/2
Superficie di lavoro Superficie de travail des brosses Area de trabajo cepillos	mm	300	300	300	600	600	800
Altezza massima di lavoro Hauteur maximum de travail Altura max de trabajo	mm	300 110	300 110	300 110	300 110	300 110	300 110
Motore spazzola Moteur brosse Motor cepillo	Kw	1x1,1	2x1,1	4x1,1	2x2,2	4x2,2	2x2,2
Potenza moto-variante tappeto Force mouvement variateur tapis Potencia moto-variador patin	Kw	0,18	0,18	0,18	0,37	0,37	0,37
Velocità di avanzamento Vitesse d'avancement Velocidad de avance	mt/min	3/10	3/10	3/10	3/10	3/10	3/10
Ø Spazzola Ø Brosse Ø Cepillo	mm	200 220	200 220	200 220	200 250	200 250	200 250
Ø aspirazione Ø aspiration Ø aspiracion	mm	1x120	2x120	4x120	2x140	4x140	2x140
Peso netto / Poids net / Peso neto	Kg	330	440	830	750	1420	830



SL 220
Option
Spazzole laterali
Brosses latérales
Cepillos laterales



SL220



GP PRESSE

PRESSE / PRESSÉES / PRENSAS

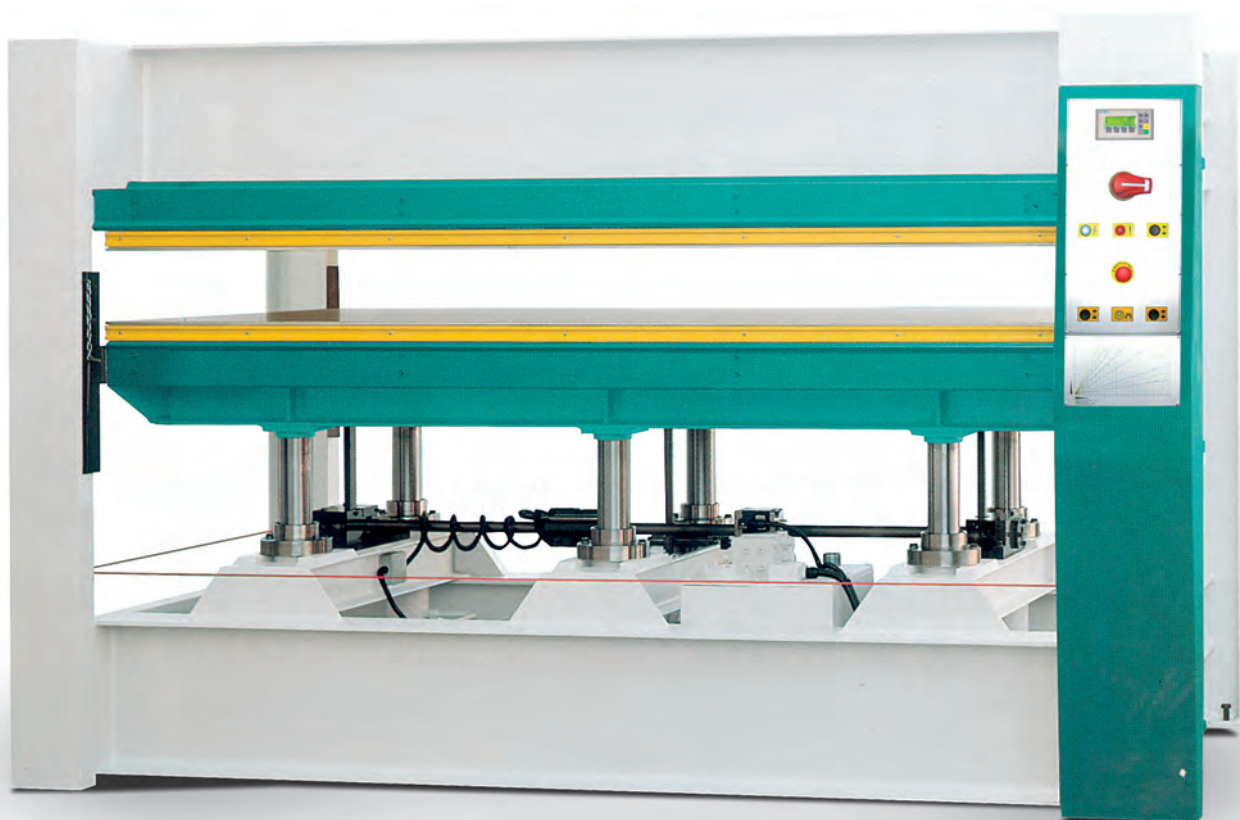

GP - GPR



Standard
Boiler elettrico ad acqua
Chaudière électrique à eau
Calentador eléctrico a agua



Standard
Caldia a legna
Chaudière en bois
Caldera a madera

p 160

Dati tecnici

Données Techniques - Datos Técnicos

		GP 20F	30F	30 3F	40F	40 3F	40S	50S	60S
Dimensioni piani Dimensions plateaux Dimension Mesas	mm	2500x1300	2500x1300	3000x1300	2500x1300	3000x1300	2500x1300	2500x1300	2500x1300
Spinta totale Poussée totale Presion total	ton	T 10	T 20	T 15	T 20	T 30	T 20	T 30	T 40
Pistoni Pistons Pistones	n.	2x65	4x65	4x65	4x55	4x55	4x55	4x70	4x70
Corsa Course Carrera	mm	500	500	500	500	500	500	300	400
Pressione Pression Presion	Kg/m ²	1	1,5	1,5	1,5	1,5	1,5	1,5	1,5
Motore Moteur Motor	Hp	2	2	2	2	2	2	2	2
Caldia Chaudière Caldera	Kcal/h	—	—	—	—	—	20.000	20.000	20.000
Boiler Boiler Boiler	HP	—	—	—	—	—	—	—	18

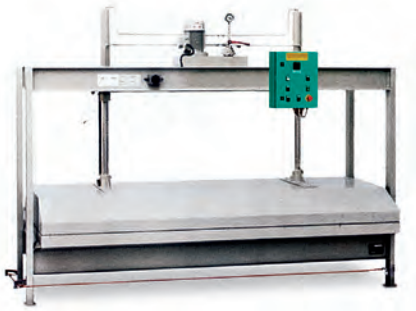

GP20F



GP40F - GP40/3F

GP F

PRESA A FREDDO
PRESSE À FROID
PRESNA A FRIO

GP

PRESSE OLEODINAMICHE
A CALDO
PRESSE À CHAUD
OLEODINAMIQUE
PRESNA OLEODINAMICA
CALIENTE

GPR

PRESSE A PIANI
CON RESISTENZE ELETTRICHE
PRESSE AVEC PLATEAUX CHAUFFES
PAR RESISTANCE ELECTRIQUES
PRESNA CON MESAS CALIENTES POR
MEDIO DE RESISTENCIAS ELECTRICAS



GP30F - 30/3F



GP - GPR



GPM



OLS-E



PM AIR SYSTEM

Dati tecnici <i>Données Techniques - Datos Tecnicos</i>		80S	85S	70S	100S	120S	90S	130S	150S
Dimensioni piani <i>Dimensions plateaux</i> Diemension Mesas	mm	2500x1300	2500x1300	3000x1300	3000x1300	3000x1300	3500x1300	3500x1300	3500x1300
Spinta totale <i>Poussée totale</i> Presion total	ton	T 60	T 90	T 50	T 70	T 90	T 90	T 120	T 160
Pistoni <i>Pistons</i> Pistones	n.	4x70	4x70	6x70	6x70	6x70	6x70	6x85	6x85
Corsa <i>Course</i> Carrera	mm	400	400	300	400	400	450	450	450
Pressione <i>Pression</i> Presion	Kg/m ²	2	3	2	2	2	2	3	3,5
Motore <i>Moteur</i> Motor	HP	2	2	2	2	2	2	3	3
Caldaia <i>Chaudière</i> Caldera	Kcal/h	20.000	20.000	20.000	20.000	29.900	29.900	29.900	29.900
Boiler <i>Boiler</i> Boiler	HP	21	21	21	21	21	21	27	27



GRR 300-800-1300-1400-1600

INCOLLATRICE - ENCOLLEUSES - ENCOLLADORAS



CE

p 161 Dati tecnici Données Techniques - Datos Tecnicos		2 RULLI	4 RULLI
Larghezza di lavoro Largeur de travail Ancho de trabajo	mm	300-800-1300-1600	1300-1400-1600
Spessore max di lavoro Epaisseur maxi de travail Espesor max de trabajo	mm	100	100
Velocità di lavoro Vitesse de travail Velocidad de trabajo	M/1'	20	20
N° 2 Rulli spalmatori SH 55/60 No 2 rouleaux répard colle SH 55/60 No 2 rodillos untadores SH 55/60	Ø	190	215
N° 2 Rulli dosatori in ebanite No 2 doseurs en ébonite No 2 rodillos dosificadores en ebonita	Ø	—	180
Spessore gomma Epaisseur caoutchouc Espesor goma	mm	11	13
Motoriduttore Motoréducteur Motoreductor	Hp	0.5	1

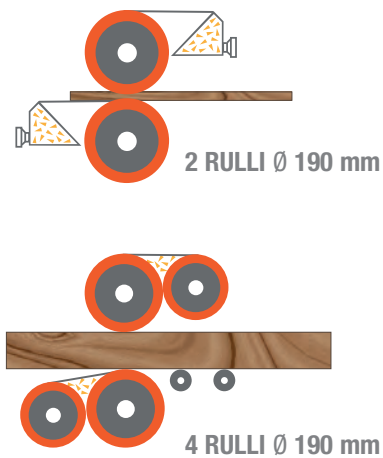

PRESSA VACUUM PER IMPIALLACCIATURA
 PRESSES SOUS VIDE POUR LE PLACAGE
 PRENSA VACUUM PARA ENCHAPADO



CE



p 161



Dati tecnici

Données Techniques - Datos Técnicos

GPM 300

Dimensioni <i>Dimensions</i> Medidas	mm	3000x1300
Spessore massimo di lavoro (compresa contro sagoma) <i>Epaisseur maxi d'usinage (le contre profil compris)</i> Espesor mínimo de trabajo (incluido el contro perfil)	mm	400
Membrana in gomma 45 Sh. <i>Membrane en ctc 45 Sh.</i> Membrana en goma 45 Sh.	mm	1400x3100 x 3 (thick)
Pressione <i>Pression</i> Prension	T/m ²	8
Pompa vuoto <i>Pompe vide</i> Bomba a vacío	m ³ /h	25
Pompa (assorbimento massimo) <i>Pompe (absorption maxi)</i> Bomba (absorbimiento máximo)	Kw	0,75
Massima temperatura di esercizio <i>Température maxi d'exercice</i> Maxima temperatura de trabajo	°C	60°
Riscaldamento (assorbimento massimo) <i>Chauffage (absorption maxi)</i> Calentamiento (absorbimiento máximo)	Kw	4,5



GB 60/10

BORDATRICE CON VASCA COLLA PER PEZZI DRITTI E CURVATI
 PLAQUEUSE DE CHANTS POUR PIECES DROITES ET COURBES
 CHAPEADORA DE CANTO CON VASCA COLA PARA PIEZAS RECTAS Y CURVADAS

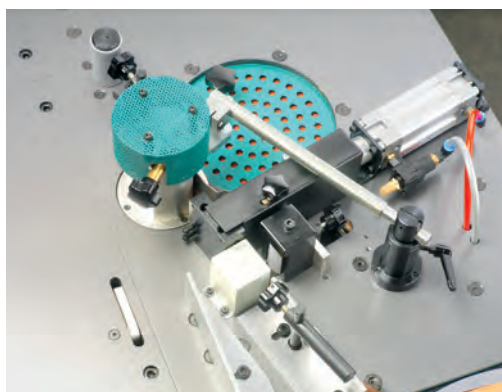

n. 1 rullo (altezza 60 mm) per spalmare la colla sul bordo
 n. 1 rouleau (hauteur 60 mm) pour appliquer la colle sur le bord
 n. 1 rodillo (altura 60 mm) para untar la cola en le canto

CE

p 162	Dati tecnici	GB 60/10
	<i>Données Techniques - Datos Técnicos</i>	
Altezza min.-max bordo <i>Hauteur min.-maxi du chant</i> Altura min.-max del canto	mm	10-60
Spessore min./max bordo <i>Epaisseur min.-maxi du chant</i> Espesor min.-max. del canto	mm	0.3/3
Velocità di avanzamento <i>Vitesse entrainement</i> Velocidad de avance	mt/1'	7-12-17
Raggio minimo con curvatura concava <i>Rayon minimum avec courbe concave</i> Radio minimo con curva concava	mm	20
Potenza motore <i>Puissance moteur</i> Potencia motor	KW(HP-CV)	3(4)
Pressione di esercizio <i>Pression de service</i> Presion de ejercicio	atm	7/8

GR 91 N

REFILATORE UNIVERSALE ROGNEUR UNIVERSEL REFILADOR UNIVERSAL

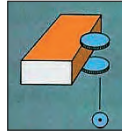

p 162	Dati tecnici	GR 91
	<i>Données Techniques - Datos Tecnicos</i>	
	Potenza motori <i>Puissance de moteurs</i> Potencia dos motores	KW (HP- CV) 0,5 (0,7)
	Velocità frese <i>Vitesse des outils</i> Velocidad das fresas	rpm 12000
	Altezza rifilatura min.-max. <i>Epaisseur de afileurage</i> Dureza 1° rodillo	mm 10-60
	Spessore massimo del bordo <i>Epaisseur de aleisses</i> Grueso del canto	mm 3

CE

GRA

ARROTONDATORE PER ANGOLI E BORDI ARROTONDATI ARRONDISSEUR POUR ANGLES ET CHANTS ARRONDIS REDONDEADOR PARA ANGULOS Y CANTOS RETONDEADO

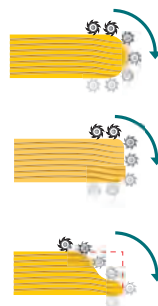

CE

p 162	Dati tecnici	GRA
	<i>Données Techniques - Datos Tecnicos</i>	
	Spessore del pezzo min.-max. <i>Epaisseur du piece min.-maxi</i> Espesor de la pieza min.-max.	mm 16-50
	Larghezza min. <i>Largeur min.</i> Acho min.	mm 80
	Max. spessore del bordo <i>Maxi epaisseur du chant</i> Max. espesor del canto	mm 3

GRA

GB 2/3 - GB 3/3 - GB 4/3

BORDATRICI AUTOMATICHE
 PLAQUESES A CHANTS AUTOMATIQUE
 CHAPEADORAS DE CANTOS AUTOMATICA

SIEMENS

Schneider
 Electric

Telemecanique

Bordatrici automatiche

per l'applicazione di bordi in rotolo o in strisce in PVC; ABS; melaminico; impiallacciatura; masselli.

Plaqueuse de chants automatique

pour bords en rouleau ou en bandes en PVC, ABS, mélamine, plaqué et massif.

Chapeadora de canto automatica

para cantos en rollo o en tiras en PVC, ABS, melamina, madera y listones.

Le macchine sono complete di:

- Ruote spostamento macchina
- Supporto porta rotoli diam.800 mm
- Vasca colla teflonata con sistema di riscaldamento rapido, capacità 2 lt
- Vasca colla teflonata con controllo elettronico della temperatura a 200°-130°. Durante la fase in cui la macchina non lavora, la temperatura si abbassa automaticamente da 200° a 130°
- * Gruppo cesoia con sistema pneumatico per taglio bordi da 0,4 a 3 mm con ritorno automatico del bordo
- * Frese raggio 2 mm a 4 coltelli
- Gruppo pressione del bordo completo di 2 rulli, regolabile:
 - 1° rullo motorizzato con sistema di pressione indipendente e regolabile
 - 2° rullo folle con sistema di pressione indipendente e regolabile
- Sostegno laterale per pannelli di grandi dimensioni con rulliera
- N° 1 bocca aspirazione diam 50 mm
- N° 1 bocca aspirazione diam 100 mm
- Pressione superiore manuale con ruote gommate con regolazione tramite lettore numerico
- Normativa "CE"

Machines équipées de:

- Galets déplacement machines
- Support porte-bobines diamètre 800 mm
- Bac colle en teflon avec système de chauffage rapide, capacité 2 lt
- Bac colle en teflon avec contrôle électrique température à 200°-130°. Pendant la phase où la machine ne travaille pas, la température baisse automatiquement de 200° à 130°
- * Groupe cisailles avec système pneumatique pour coupe chant de 0,4 à 3 mm avec retour automatique du chant
- * Outils rayon 2 mm à 4 couteaux
- Groupe pression du chant complet de 2 rouleaux réglable:
 - 1er rouleau motorisé avec système de pression indépendant et réglable
 - 2ème rouleau neutre avec système de pression indépendant et réglable
- Support lateral pour panneaux de grands dimensions avec rouleaux
 - n.1 buse d'aspiration diam. 50 mm
 - n.1 buse d'aspiration diam. 100 mm
- Pression supérieure manuelle avec roues caoutchoutées avec réglage par affichage numérique
- Normes 'CE'

Las maquinas son completas de:

- Ruedas desplazamiento maquinas
- Soporte lleva rodillos diam. 800 mm.
- Vasca cola en teflon con sistema de calentamiento rapido capacidad 2 lt
- Vasca cola en teflon con control electronico de la temperatura a 200°-130°C. Cuando la maquina no trabaja, la temperatura baja en automatico de 200° a 130°
- * Grupos cizalla con sistema neumatico para corte de canto de 0,4 a 3 mm con vuelta automatica del canto
- * Fresa rayo 2 mm a 4 cuchillas
- Grupo prensor del canto completo de rodillos regulables:
 - 1° rodillo motorizado con sistema de presion neumatica independiente y regulable
 - 2° rodillo neutro con sistema de presion independiente y regulable
- Soporte lateral para tableros grandes con camino de rodillos
 - n. 1 boca de aspiracion diam. 50 mm.
 - n. 1 boca de aspiracion diam. 100 mm.
- Presion superior manual con ruedas en goma con regulacion por lector numerico
- Normativa CE



GB 2/3



GB 3/3



GB 4/3



GB 2/3



GB 3/3

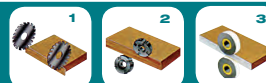

GB 4/3

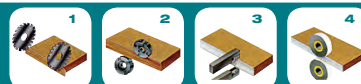



GB 2/3

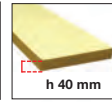
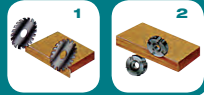

GB 2/3

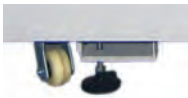

STANDARD



GB 2/3



GB 3/3



GB 4/3

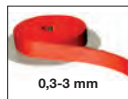
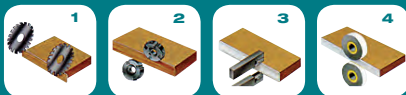

0,3-3 mm

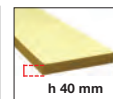

h 40 mm



STANDARD

GB 4/3

CE



GB 4/3



GB 2/3



GB 4/3

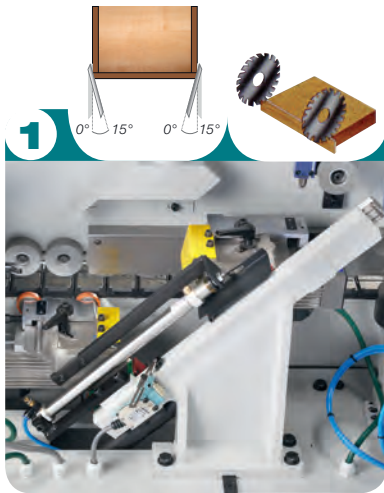

GRUPPO INTESTATORE
con 2 motori HF inclinabili 0° -15°.

GRUPE DE COUPE EN BOUT
avec 2 moteurs HF inclinables 0°-15°.

GRUPO RETESTADOR
con 2 motores HF inclinables 0°-15°.



GRUPPO REFILATORE con 2 motori HF con regolazione micrometrica e lettore digitale numerico - N° 2 frese con raggio 2 mm.

GRUPE RACLAGES DES COTES avec 2 moteurs HF réglage micrométrique avec lecteur digital numérique - N. 2 outils avec rayon 2 mm.

2° GRUPO REFILADOR-AFINADOR con 2 motores HF y regulación micrométrica con lector digital numerico - N. 2 fresas con rayo 2 mm.



GRUPPO RASCHIATORE
con lettore digitale numerico.

GRUPE DE RACLEUR DE BORDS
avec lecteur digital Numérique.

GRUPO RASCACANTO
con lector digital numerico.



GRUPPO SPAZZOLATORE a 2 motori kw 0,37 con dischi in stoffa diam. 150 mm.

GRUPE DE BROSSAGE à 2 moteurs kw 0.37 avec disques en étoffe diam. 150 mm.

GRUPO PULICANTO con 2 motores kw 0,37 con discos en tela diam. 150 mm.

p 162

Dati tecnici

Données Techniques - Datos Técnicos

GB 2/3 - GB 3/3 - GB 4/3

Larghezza minima pannello <i>Largeur minimum du panneau</i> Ancho mínimo del panel	mm	90	Pressione d'aria <i>Pression de l'air</i> Presion aire	bar	6,5
Lunghezza minima pannello <i>Longueur minimum du panneau</i> Largo mínimo del panel	mm	200	Spessore del bordo <i>Epaisseur du bord</i> Espesor del canto	mm	0,4-3
Spessore max. pannello <i>Epaisseur max. du panneau</i> Espesor max del panel	mm	40	Potenza istallata <i>Puissance installée</i> Potencia instalada	Kw	6,5
Spessore min. pannello <i>Epaisseur minimum du panneau</i> Espesor mínimo del panel	mm	10			
Velocità dell' avanzamento <i>Vitesse de l'entraînement</i> Velocidad de avance	m/1'	8			
Capacità vasca colla <i>Capacité de la cuve à colle</i> Capacidad deposito cola	lt	2			



Standard

Vasca colla teflonata
Cuve colle téflonisée
Calderin teflonado

GB 2/8 - GB 4/8 - GB 5/15 - GB 5/8R - GB 6/15R

BORDATRICI AUTOMATICHE
 PLAQUESES A CHANTS AUTOMATIQUE
 CHAPEADORAS DE CANTOS AUTOMATICA

SIEMENS

Schneider
 Electric

Telemecanique

Bordatrici automatiche

per l'applicazione di bordi in rotolo o in strisce in PVC; ABS; melaminico; impiallacciatura; masselli.

Plaqueuse de chants automatique

pour bords en rouleau ou en bandes en PVC, ABS, mélamine, plaqué et massif.

Chapeadora de canto automatica

para cantos en rollo o en tiras en PVC, ABS, melamina, madera y listones.



GB 2/8



GB 4/8

GB 5/15



GB 5/8 R

GB 6/15 R



GB 4/8 A

GB 5/8 RA

GB 5/15 RA

Le macchine sono complete di:

- Supporto porta rotoli diam. 800 mm.;
- Caricatore automatico dei bordi in strisce;
- Vasca colla termofusibile con sistema di riscaldamento rapido capacità 4 lt;
- Vasca colla teflonata;
- Vasca colla con controllo elettronico della temperatura a 200°-130°.

Durante la fase in cui la macchina non lavora la temperatura si abbassa automaticamente da 200° a 130°

- N°2 gruppi cesoia:
 - * 1° gruppo cesoia con sistema pneumatico per taglio bordi da 0,4 a 1 mm con ritorno automatico del bordo;
 - * 2° gruppo cesoia con sistema pneumatico per taglio bordi in PVC e ABS, spessore max 3 mm;
- Frese per lavorazione massello fino a 8 mm - raggio 2 mm per lavorazione bordi;
- Box raccogli trucioli ABS;
- Spazzole diam. 150 mm;
- n°2 velocità di avanzamento 12-16 m/1' (N° 1 velocità a 12 m/1' - 39 Ft/1' - V. 230\60HZ);
- Quadro comandi a pensile orientabile;
- Gruppo pressione del bordo completo di 3 rulli, regolabile con lettore digitale numerico;
- 1° rullo motorizzato con sistema di pressione pneumatica indipendente e regolabile;
- 2° e 3° rullo folle con sistema di pressione pneumatica indipendente e regolabile;
- Sostegno laterale per pannelli di grandi dimensioni con rulliera;
- Regolazione automatica dei gruppi in altezza con lettore digitale numerico;
- Aspirazione centralizzata;
- Pressione superiore manuale a doppia fila di ruote gommate con regolazione tramite lettore digitale numerico;
- Normativa "CE"

Machines équipées par:

- Support porte-bobines diamètre 800 mm;
- Chargeur automatique des bords en bandes;
- Cuve colle thermo fusible avec système de chauffage rapide
- Cuve colle téflonisée;
- Cuve colle avec contrôle électrique de la température à 200°-300°.

Pendant la phase où la machine ne travaille pas, la température baisse automatiquement de 200° à 130°.

- N° 2 groupes ciseaux:
 - * 1er groupe ciseaux avec système pneumatique pour coupe des bords de 0,4 à 1 mm avec retour automatique du bord;
 - * 2ème groupe ciseaux avec système pneumatique pour coupe des bords en PVC et ABS épaisseur maxi 3 mm;
- Panneau sur potence orientable;
- Groupe pression du bord complet de 3 rouleaux réglable avec lecteur digital numérique;
- 1er rouleau motorisé avec système de pression pneumatique indépendant et réglable;
- 2ème et 3ème rouleaux fou avec système de pression pneumatique indépendant et réglable;
- Support latéral pour panneaux de grandes dimensions avec rouleaux;
- Outils, rayon 2 mm pour usinage des bords et usinage du massif jusqu'à 8 mm;
- Boite récolte trous abs séparés;
- Brosses diam. 150 mm;
- N° 2 vitesses entrainement 12-16 m/1' (N° 1 vitesse à 12 m/1' - 39 Ft/1' - V. 230\60HZ);
- Réglage automatique des groupes en hauteur avec lecteur digital numérique;
- Aspiration centralisée;
- Pression supérieure manuelle à double ligne de roues en ctc avec réglage par lecteur digitale numérique;
- Normes 'CE'.

Las maquinas son completas de:

- Soporte lleva rodillos diam. 800 mm.;
 - Cargador automatico de los cantos en tiras;
 - Vasca cola termofusible con sistema de calentamiento rapido capacidad 4 lt;
 - Calderin teflonado
 - Vasca cola con control electronico de la temperatura a 200°-130°.
- Quando la maquina no trabaja, la temperatura de baja en automatico de 200° a 130°.
- 2 grupos cizalla:
 - * 1° grupo cizalla con sistema neumatico para corte de canto de 0,4 a 1 mm con vuelta automatica del canto;
 - * 2° grupo cizalla con sistema neumatico para corte de canto en PVC y ABS espesor max 3 mm.;
 - Fresa, rayo 2 mm. para trabajo de los cantos y de madera maciza hasta 8 mm.;
 - Caja lleva viruta ABS separado;
 - Discos en tela diam. 150 mm.;
 - 2 velocidades avance de 12-16 m/1' (N° 1 velocidad a 12 m/1' - 39 Ft/1' - V. 230\60HZ);
 - Cuadro de mando a pensil orientable;
 - Grupo prensor del canto completo de 3 rodillos regulables con lector digital numerico;
 - 1° rodillo motorizado con sistema de presión neumática independiente y regulable;
 - 2° y 3° rodillo neutro con sistema de presión neumática independiente y regulable;
 - Soporte lateral para tableros grandes con camino de rodillo;
 - Regulacion automatica de los grupo en altura con lector digital numerico;
 - Aspiracion centralizada;
 - Prension superior manual a doble hilo de ruedas en goma con regulacion por lector digital numerico;
 - Normativa CE.

GB 2/8



GB 4/8



GB 5/8 R



GB 5/15



GB 6/15 R

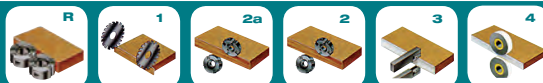

GB 4/8 A



GB 5/8 RA



GB 6/15 RA

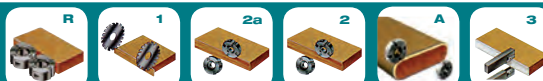

GB 4/8A - GB 5/8RA - GB 6/15 RA



GB 2/8

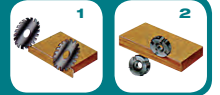

CE

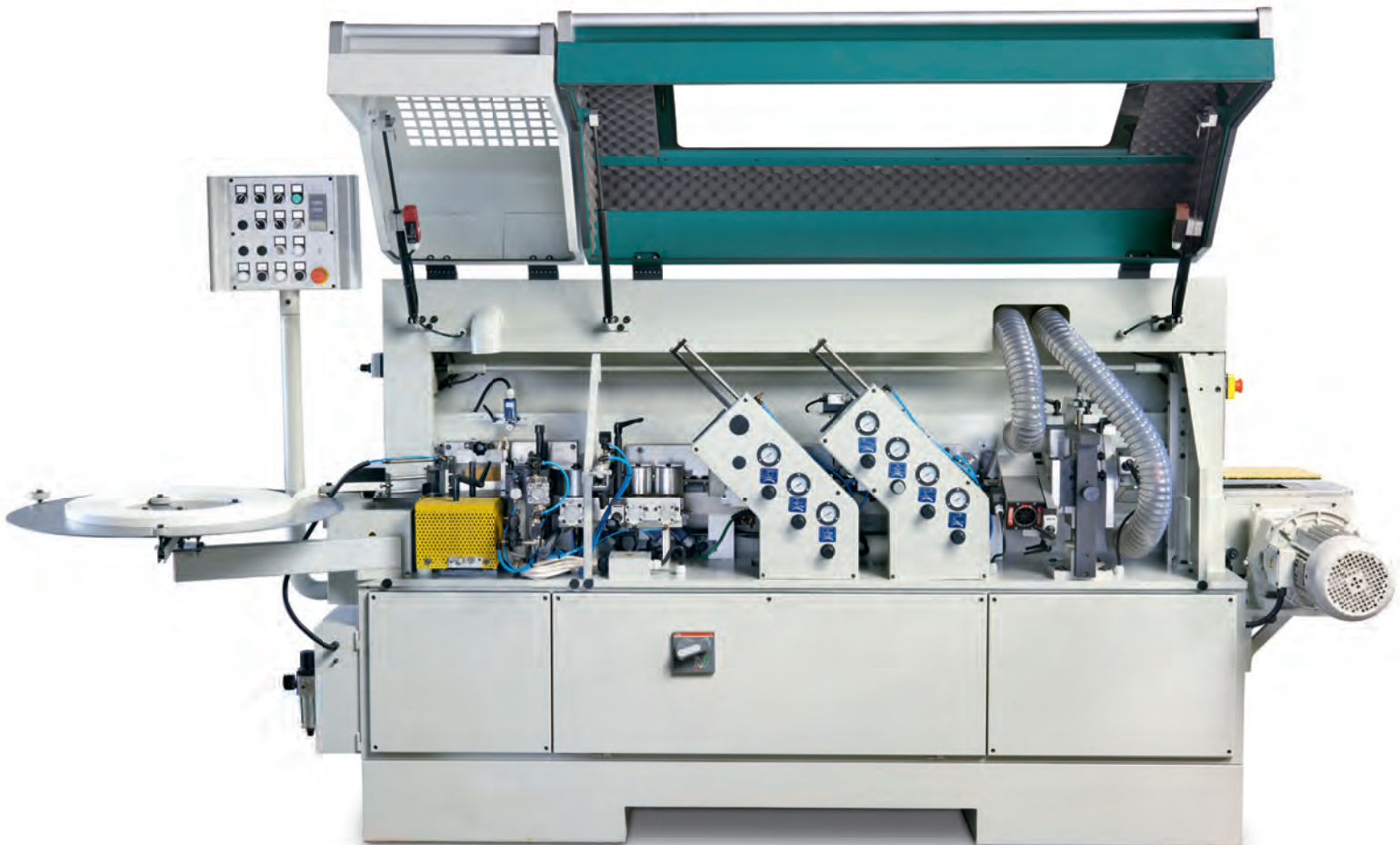

GB 2/8



GB 4/8



GB 5/15

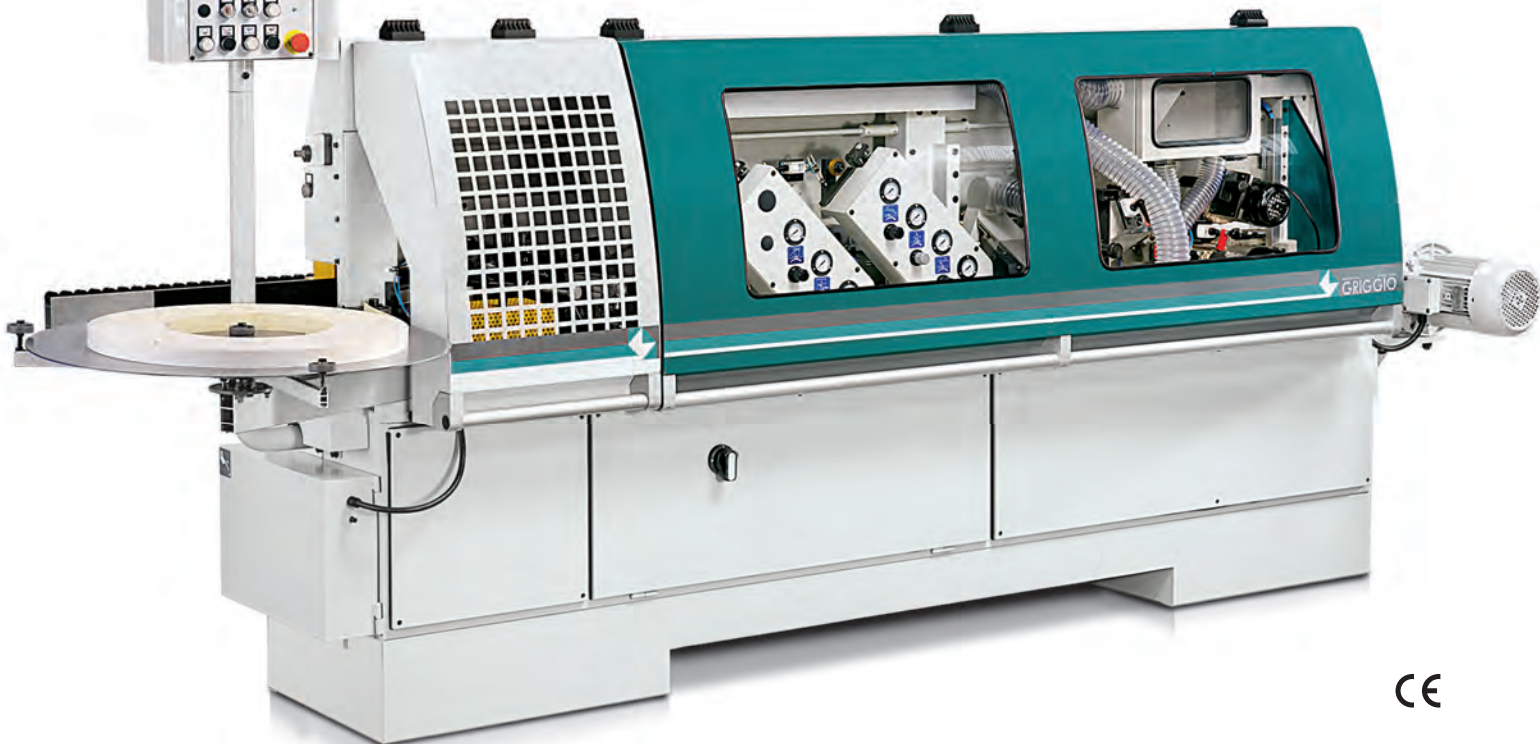
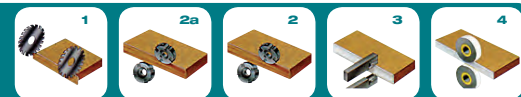

CE

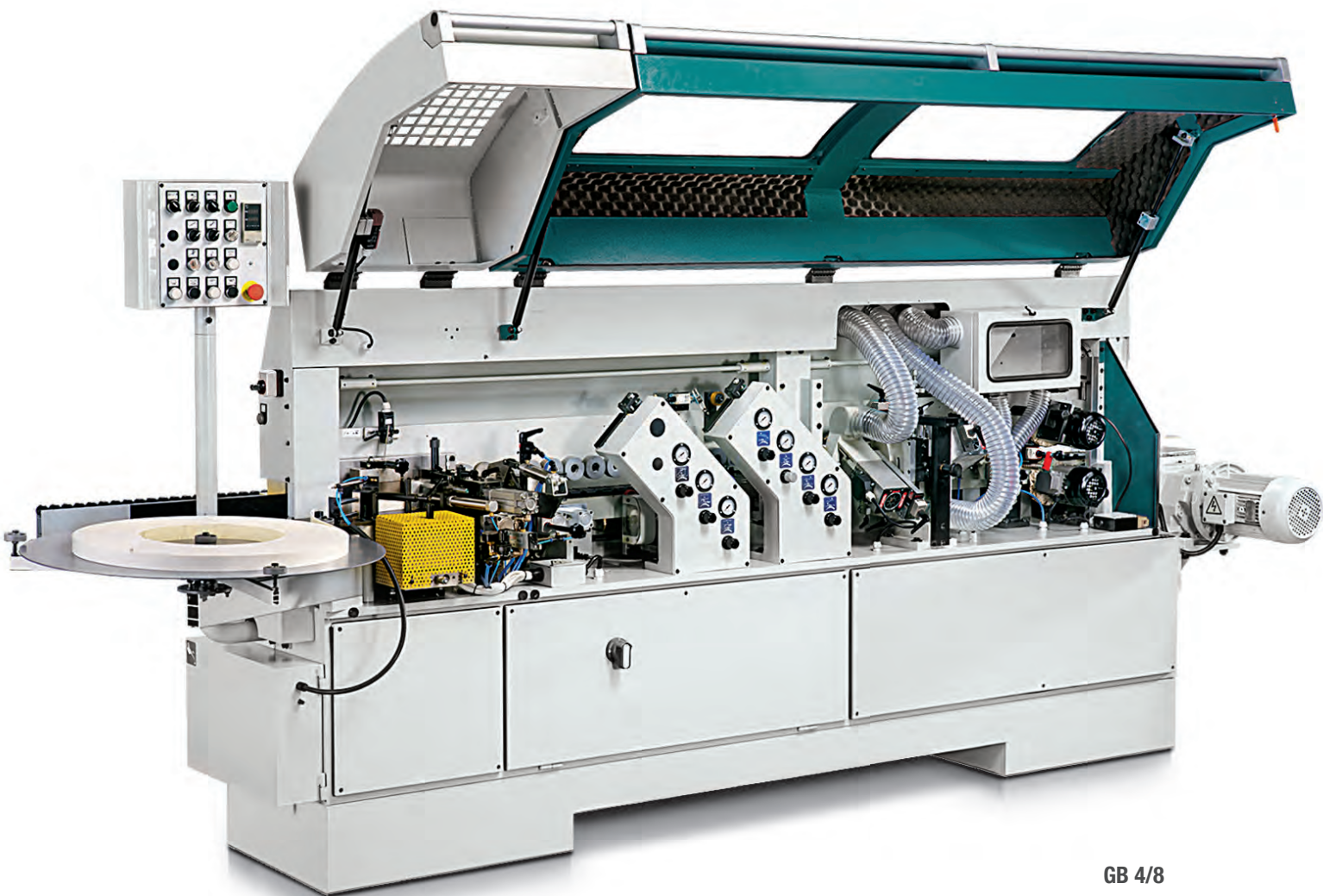

GB 4/8

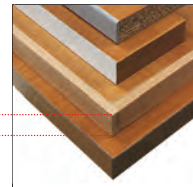

h 60 mm

- Altezza max pannelli a bordare 60 mm
- * Bordi da 0,4 a 8 mm GB 2\8 – GB4\8 –GB5\8R
GB 4/8 A - GB 5/8 RA
- * Bordi da 0,4 a 15 mm GB 5\15 – GB6\15R

- Hauteur maxi panneaux à plaquer 60 mm
- * Bords de 0,4 à 8 mm GB 2\8 – GB4\8 –GB5\8R
GB 4/8 A - GB 5/8 RA
- * Bords de 0,4 à 15 mm GB 5\15 – GB6\15R

- Altura max panel a chapear 60 mm
- * Cantos de 0,4 a 8 mm GB 2\8 – GB4\8 –GB5\8R
GB 4/8 A - GB 5/8 RA
- * Cantos de 0,4 a 15 mm GB 5\15 – GB6\15R

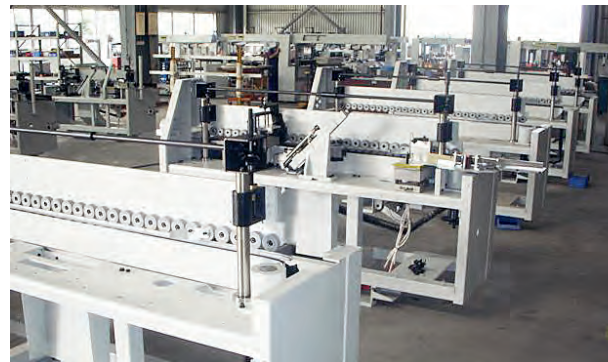

Standard

Pressione superiore manuale a doppia fila di ruote gommata con regolazione tramite lettore digitale numerico

- Sostegno laterale per pannelli di grandi dimensioni con rulliera
- * n°2 velocità di avanzamento 12-16 m/1' (N° 1 velocità a 12 m/1' - 39 Ft/1' V. 230\60HZ)

Standard

Pression supérieure manuelle à double ligne de roues en ctc avec réglage par lecteur digitale numérique

- Soutien latéral pour panneaux de grandes dimensions avec rouleaux
- * N° 2 vitesses entrainement 12-16 m/1' (N° 1 vitesse à 12 m/1' - 39 Ft/1' V. 230\60HZ)

Standard

Preñsion superior manual a doble hilo de ruedas en goma con regulacion por lector digital numerico

- Soporte lateral para tableros grandes con camino de rodillo
- * N. 2 velocidades avance de 12-16 m/1' (N° 1 velocidad a 12 m/1' - 39 Ft/1' V. 230\60HZ)

p 162

Dati tecnici

Données Techniques - Datos Tecnicos

GB 2/8 - GB 4/8 - GB 5/8 R - GB 5/15 - GB 6/15 R

Larghezza minima pannello Largeur minimum du panneau Ancho mínimo del panel	mm	90	Pressione d'aria Pression de l'air Presion aire	bar	6
Lunghezza minima pannello Longueur minimum du panneau Largo mínimo del panel	mm	180	Emissione sonora Emission sonore Emision ruido	dB	72
GB/R Lunghezza minima pannello Longueur minimum du panneau Largo mínimo del panel	mm	280	Spessore del bordo Epaisseur du bord Espesor del canto	mm	0,4-8 (GB 2-4-5/8) 0,4-15 (GB 5-6/15)
Spessore max. pannello Epaisseur max. du panneau Espesor max del panel	mm	60	Potenza installata Puissance installée Potencia instalada	Kw	7-8-12-10-13
Spessore min. pannello Epaisseur minimum du panneau Espesor mínimo del panel	mm	12			
Velocità dell' avanzamento Vitesse de l'entraîneur Velocidad de avance	m/1'	12-16			
Capacità vasca colla Capacité de la cuve à colle Capacidad deposito cola	lt	4			



GRUPPO RETTIFICA

standard:

- N. 2 frese in acciaio HM Dia. 80x50xF20 mm
Altezza utile di lavoro 45 mm
- Complete di:
3+3 coltellini ad inserto in HM:
3 - 40x12x1,5
3 - 15x12x1,5
massima esportazione 2 mm

option:

- N. 2 Frese in Diamante 80x55xF20 mm
Altezza utile di lavoro 50 mm
- N. 2 Frese in Diamante 80x65xF20 mm
Altezza utile di lavoro 60 mm

GROUPE DE RECTIFICATION

Standard:

- N. 2 outils en acier HM diam. 80x50xT20 mm
Hauteur maxi. d'usinage 45 mm
- Equipées de:
3+3 couteux à insertions en HM
3 - 40x12x1,5
3 - 15x12x1,5

Option:

- N. 2 jeu d'outils diamanté diam. 80x55xT20 mm
Hauteur maxi. d'usinage 50 mm
- N. 2 jeu d'outils diamanté diam. 80x65xT20 mm
Hauteur maxi. d'usinage 60 mm

GRUPO RECTIFICA

Standard:

- N. 2 fresas en acero HM dia. 80x50xA20 mm
Altura max. de trabajo 45 mm
- Completas de:
3+3 cuchillas a insercion en HM
3 - 40x12x1,5
3 - 15x12x1,5

Option:

- N. 2 fresas en diamante dia. 80x55xA20 mm
Altura max. de trabajo 50 mm
- N. 2 fresas en diamante dia. 80x55xA20 mm
Altura max. de trabajo 60 mm

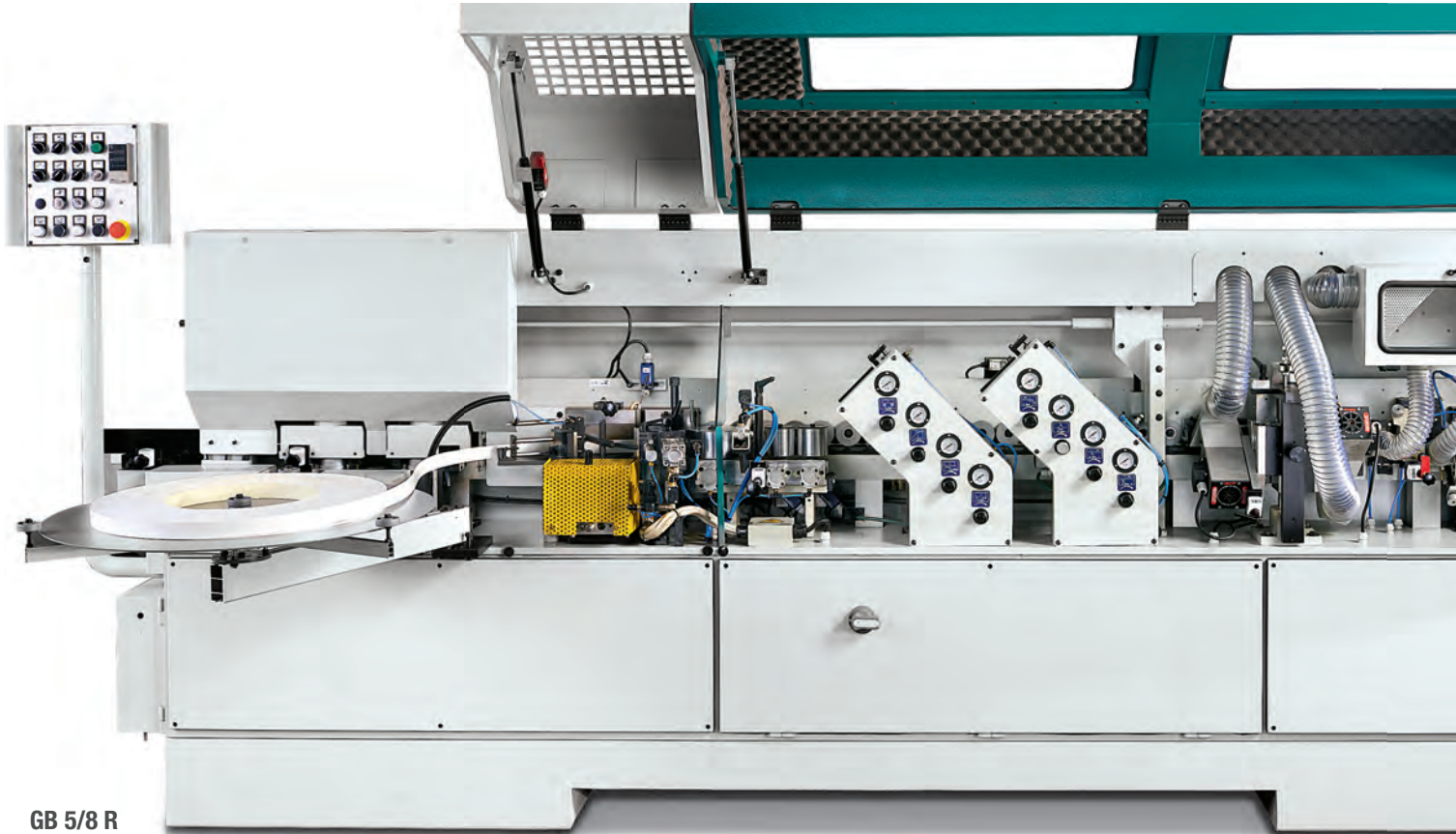

GB 5/8 R

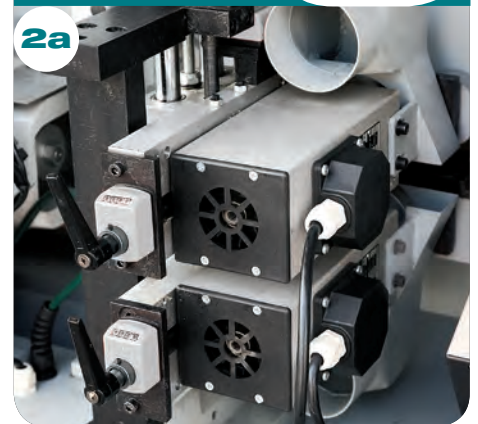
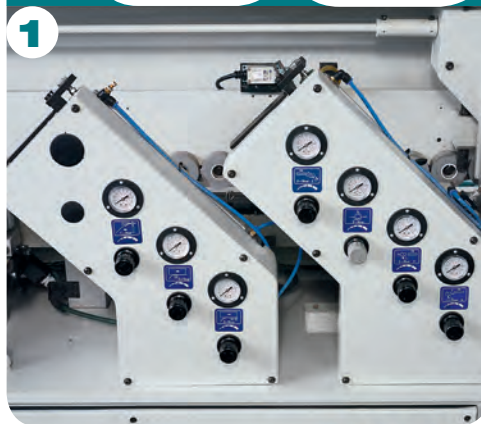
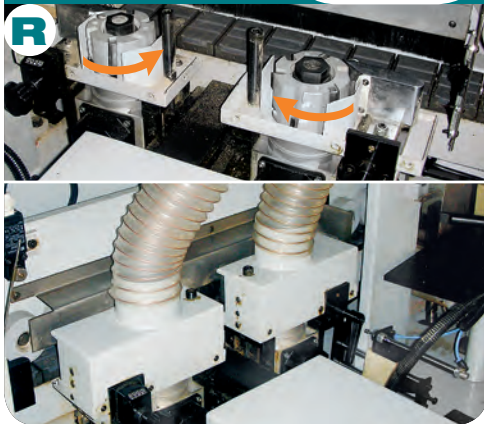
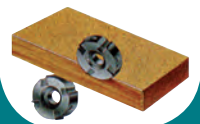
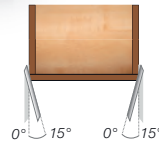

GRUPPO RETTIFICA, entrata a tempo indipendente, con 2 motori HF 12.000 g/1' - 1,8 kw cad., il 1° con rotazione antioraria, il 2° con rotazione oraria.

GROUPE DE RECTIFICATION entrée à temps indépendant avec 2 moteurs HF 12.000 T/1' - 1,8 kw cd, le 1er avec rotation antioraire et le 2ème avec rotation horaire.

GRUPO RECTIFICA en entrada a tiempo independiente con 2 motores HF 12000 g/1'-1,8 kw cada, 1° motor con rotacion antohoraria y 2° motor con rotacion oraria.

GRUPPO INTESTATORE con 2 motori HF inclinabili 0° -15°.

GROUPE DE COUPE EN BOUT avec 2 moteurs HF inclinables 0°-15°.

GRUPO RETESTADOR con 2 motores HF inclinables 0°-15°.

GRUPPO REFILATORE con 2 motori HF e regolazione micrometrica con lettore digitale numerico.

GROUPE D'AFFLEURAGE avec 2 moteurs HF et réglage micrométrique avec lecteur digital numérique.

GRUPO REFILADOR con 2 motores HF y regulacion micrometrica con lector digital numerico.



GB 5/8 R



GB 6/15 R

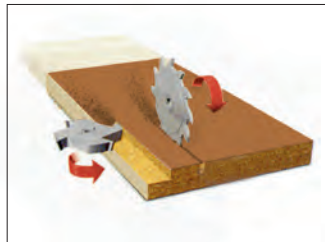
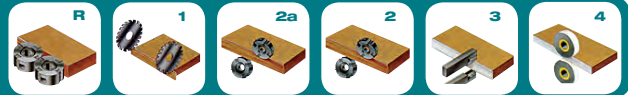

OPTION
GRUPPO TOUPIE
GROUPE TOUPIE
GRUPO TUPI

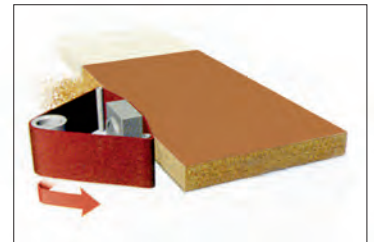

OPTION
GRUPPO LEVIGATORE
GROUPE DE PONCAGE
GRUPO LIJADOR

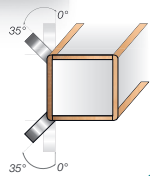

2



GRUPPO SPIGOLATORE con 2 motori HF inclinabili 0° - 35° e regolazione micrometrica con lettore digitale numerico - N° 2 fresse con raggio 2 mm.

GROUPE RACLAGE DES COTES avec 2 moteurs HF inclinables 0°-35° et réglage micrométrique avec lecteur digital numérique - N. 2 outils avec rayon 2 mm.

2° GRUPO REFILADOR-AFINADOR con 2 motores HF inclinables 0°-35° y regulacion micrometrica con lector digital numerico - N. 2 fresas con rayo 2 mm.

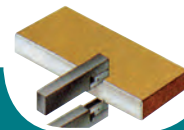

3

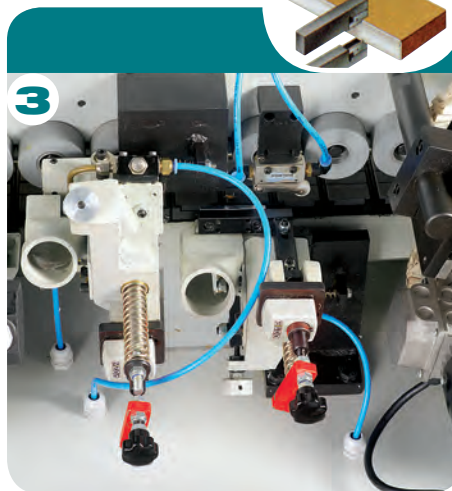

GRUPPO RASCHIATORE con lettore digitale numerico.

GROUPE DE RACLEUR DE BORDS avec lecteur digital Numérique.

GRUPO RASCACANTO con lector digital numerico.

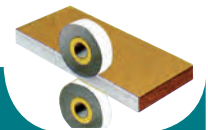

4



GRUPPO SPAZZOLATORE a 2 motori kw 0,37 con dischi in stoffa diam. 150 mm.

GROUPE DE BROSSAGE à 2 moteurs kw 0.37 avec disques en étoffe diam. 150 mm.

GRUPO PULICANTO con 2 motores 0 kw 0,37 con discos en tela diam. 150 mm.

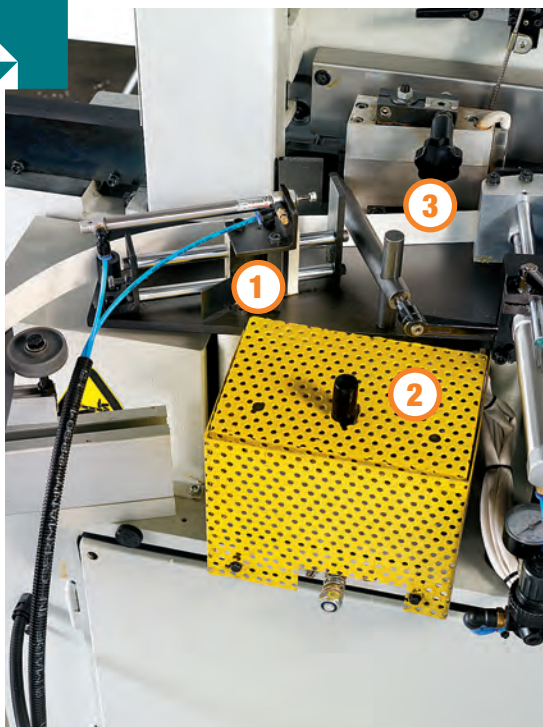

STANDARD

- 1°** Lavorazione con bordi in rotolo. Bordi da 0,4 a 1 mm con dispositivo di ritorno automatico del bordo.
- 2°** Vasca colla con controllo elettronico della temperatura a 200°-130°. Durante la fase in cui la macchina non lavora la temperatura si abbassa automaticamente da 200° a 130°
- 3°** Spintore per bordo.

STANDARD

- 1er** Usinage avec bords en rouleau. Bords de 0,4 à 1 mm avec retour automatique du bord.
- 2ème** Cuve colle avec contrôle électrique de la température à 200°-130°. Pendant la phase où la machine ne travaille pas, la température baisse automatiquement de 200° à 130°
- 3ème** Poussoir pour bord.

STANDARD

- 1°** Trabajo de los cantos en rollo. Canto de 0,4 a 1 mm con vuelta automática del canto. **2°** Vasca cola con control electrónico de la temperatura a 200°-130°. Cuando la máquina no trabaja, la temperatura de baja en automático de 200° a 130°
- 3°** Empujador para canto.



STANDARD

- 1°** Caricatore automatico dei bordi in strisce.

STANDARD

- 1er** Chargeur automatique des bords en bandes.

STANDARD

- 1°** Cargador automático de los cantos en banda.

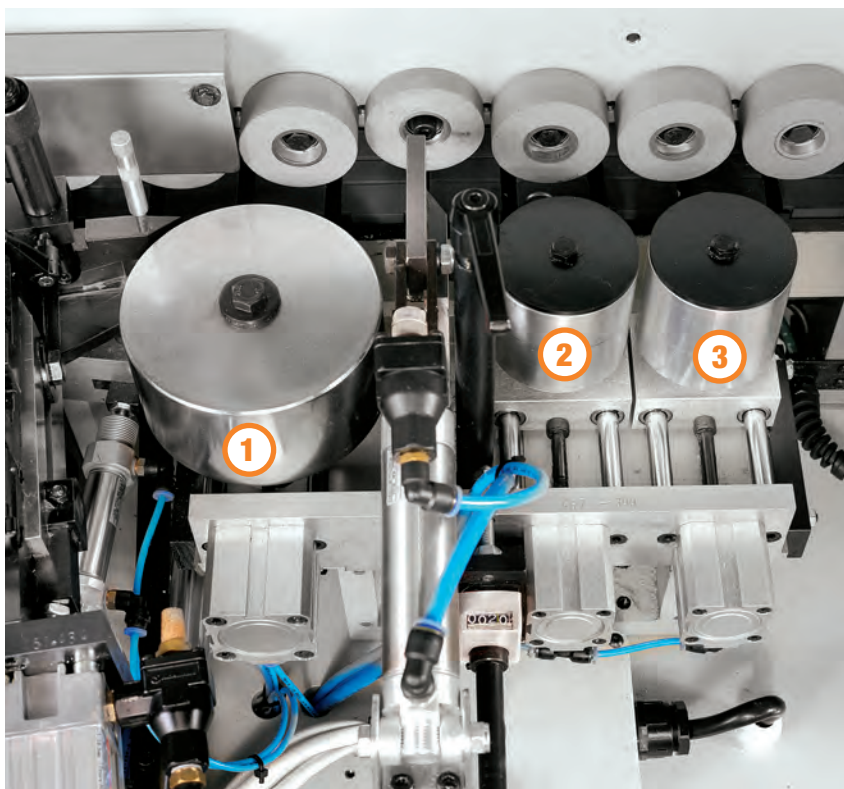

Standard
Vasca colla teflonata
Cuve colle téflonisée
Calderín teflonado

- Gruppo pressione del bordo completo di 3 rulli, regolabile con lettore digitale numerico:
1° rullo motorizzato con sistema di pressione pneumatica indipendente e regolabile;
2° e **3°** rullo folle con sistema di pressione pneumatica indipendente e regolabile.

- Groupe pression du bord complet de 3 rouleaux réglable avec lecteur digital numérique:*
1er rouleau motorisé avec système de pression pneumatique indépendant et réglable;
2ème et **3ème** rouleaux fou avec système de pression pneumatique indépendant et réglable.

- Grupo prensor del canto completo de 3 rodillos regulables con lector digital numerico:
1° rodillo motorizado con sistema de presión neumática independiente y regulable;
2° y **3°** rodillo neutro con sistema de presión neumática independiente y regulabi.

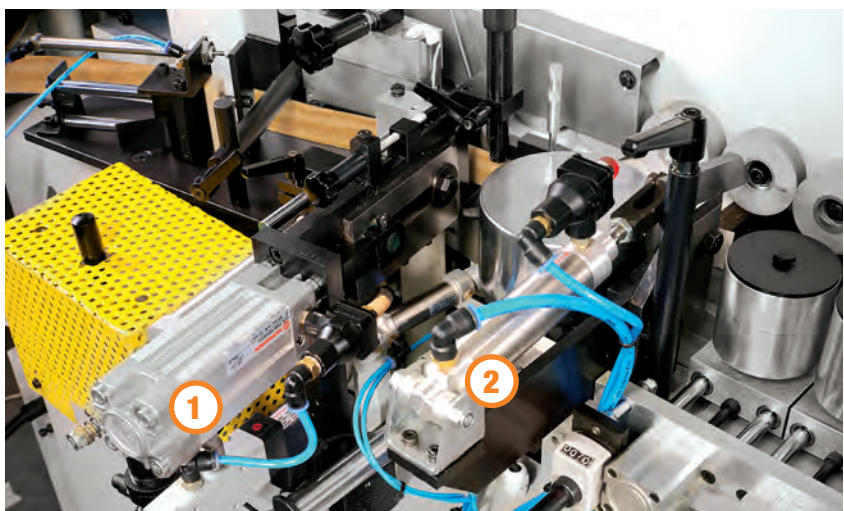

- Gruppi cesoia 1°** Cesoia con sistema pneumatico, per il taglio di rotoli in PVC e ABS spessore max. 3 mm **2°** Cesoia con sistema pneumatico, per il taglio di bordi da 0,4-1 mm.

- Groupes cisailles 1er** Cisailles avec système pneumatique, pour la coupe de rouleaux en PVC et ABS - épaisseur maxi 3 mm **2ème** Cisailles avec système pneumatique pour la coupe de bords de 0,4 - 1 mm.

- Grupo cizallas 1°** Cizalla con sistema neumático, para corte de rollo en PVC y ABS espesor max 3 mm **2°** cizalla con sistema neumático, para corte de rollo de 0,4 - 1 mm.

Gruppo refilatore inclinabile
Groupe affleurage inclinable / grupo refilador inclinable



Sistema di regolazione rapida del tastatore
(A) rispetto al bordo **(B)**

*Système de régulation rapide du tâteur
 par rapport au bord (B)*

Sistema de regulacion rapida del palpador
(A) respecto al canto **(B)**

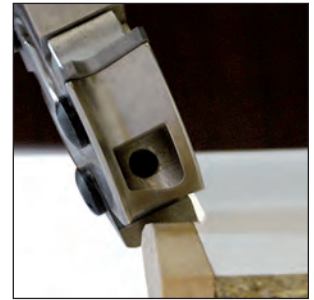

Standard
 Fresa combinata raggio 2 mm
 massello 8 mm

Option
 Raggio 3 mm

Standard
 Fraise combinée rayon 2 mm
 loupe 8 mm

Option
 Rayon 3 mm

Estandard
 Fresa combinada rayo 2 mm
 madera maciza 8 mm

A petido
 Rayo 3 mm

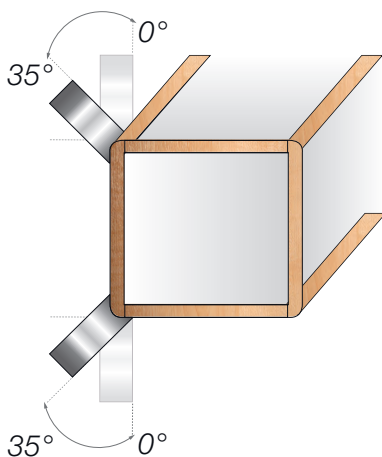
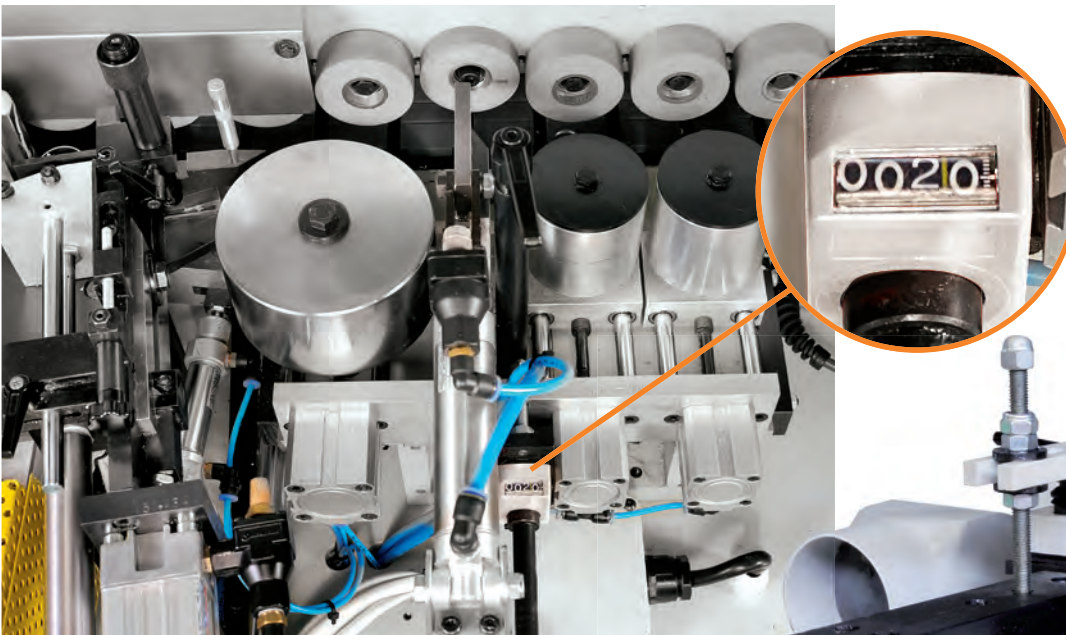

GB 4/8 A



GB 5/8 RA



GB 6/15 RA

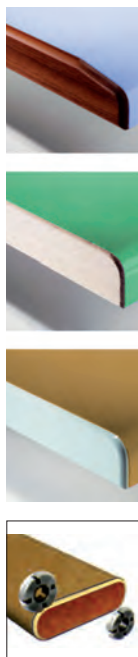

Gruppo Arrotondatore

- Controllato da PLC "SIEMENS" con posizionamento ON-OFF
- Max altezza di lavoro 45 mm.
- N°2 motori HF indipendenti HP 0,75(KW 0,55)
- Scorrimento su doppie guide lineari
- Finitura dei n°4 angoli superiori ed inferiori
- N°2 frese a 4 coltelli R.2 mm., per lavorazioni a "raggio" con bordi da 1-3 mm. e lavorazioni "dritto" con bordi da 0,4-1 mm.

Groupe arrondisseur:

- Contrôlé par le PLC "SIEMENS" avec positionnement ON-OFF
- Maxi hauteur de travail 45 mm.
- N°2 moteurs HF indépendants CV 0,75(KW 0,55)
- Glissement sur doubles guides linéaires
- Finissage des n°4 angles supérieurs et inférieurs
- N°2 outils à 4 couteaux R.2 mm pour travaux à "rayon" avec bords de 1-3 mm et travaux "droits" avec bords de 0,4-1 mm

Grupo redondador:

- Controlado de PLC SIEMENS con posicionamiento ON-OFF
- Altura max de trabajo 45 mm.
- N.2 motores HF independientes cv 0,75 (kw 0,55)
- Desplazamiento en doble guías lineares
- Acabado de n. 4 angulos superiores y inferiores
- N. 2 fresas a 4 cuchillas rayo 2 mm para trabajo a 'rayo' con cantos de 1-3 mm para trabajo 'recto' con canto de 0,4-1 mm.

GB 4/8A - GB 5/8RA - GB 6/15 RA



BORDATRICI AUTOMATICHE CON ARROTONDATORE
PLAQUESES A CHANTS AVEC DISPOSITIF D'ARRONDISSAGE
CHAPEADORAS CON GRUPO REDONDEADOR

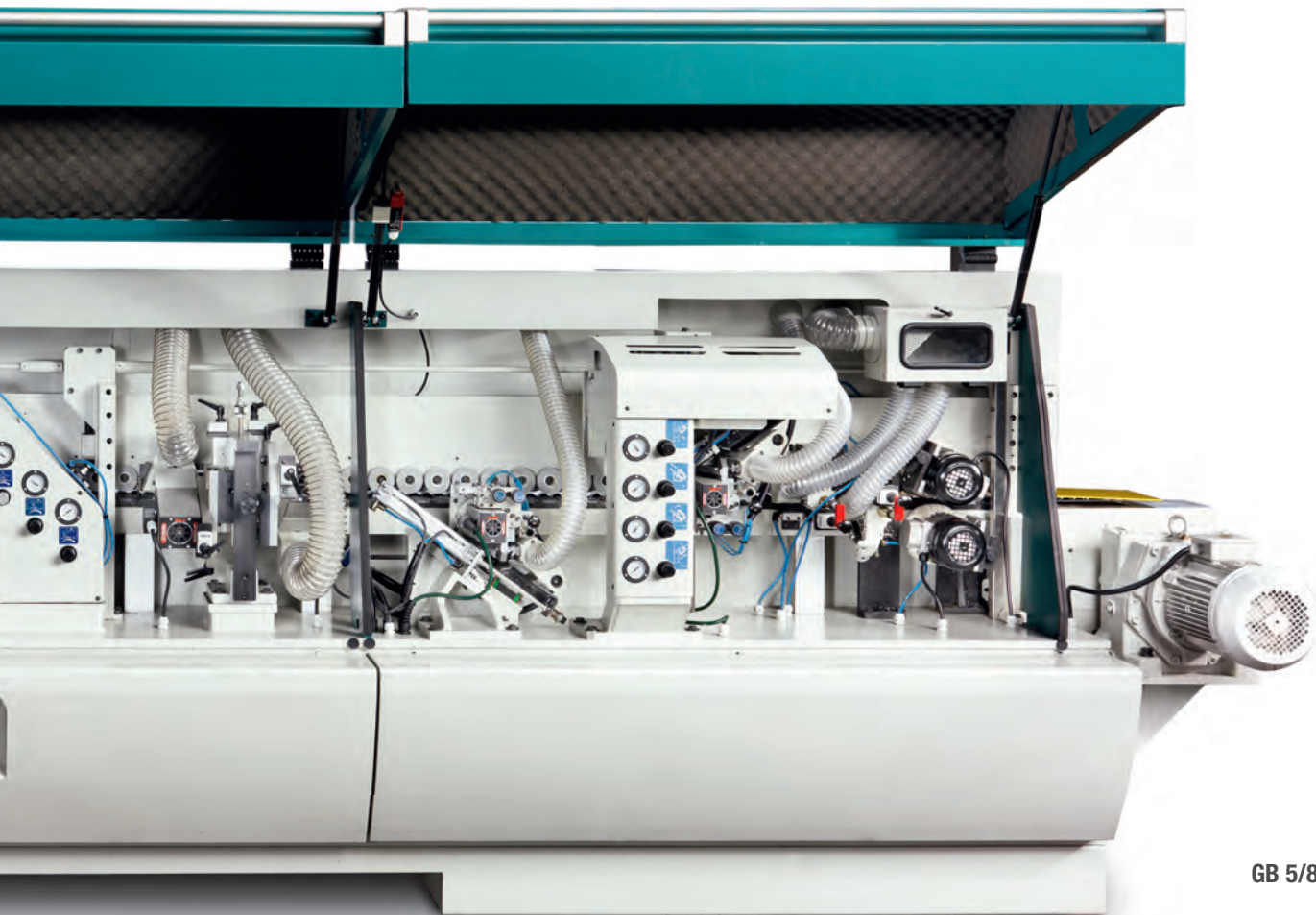

GB 5/8 RA

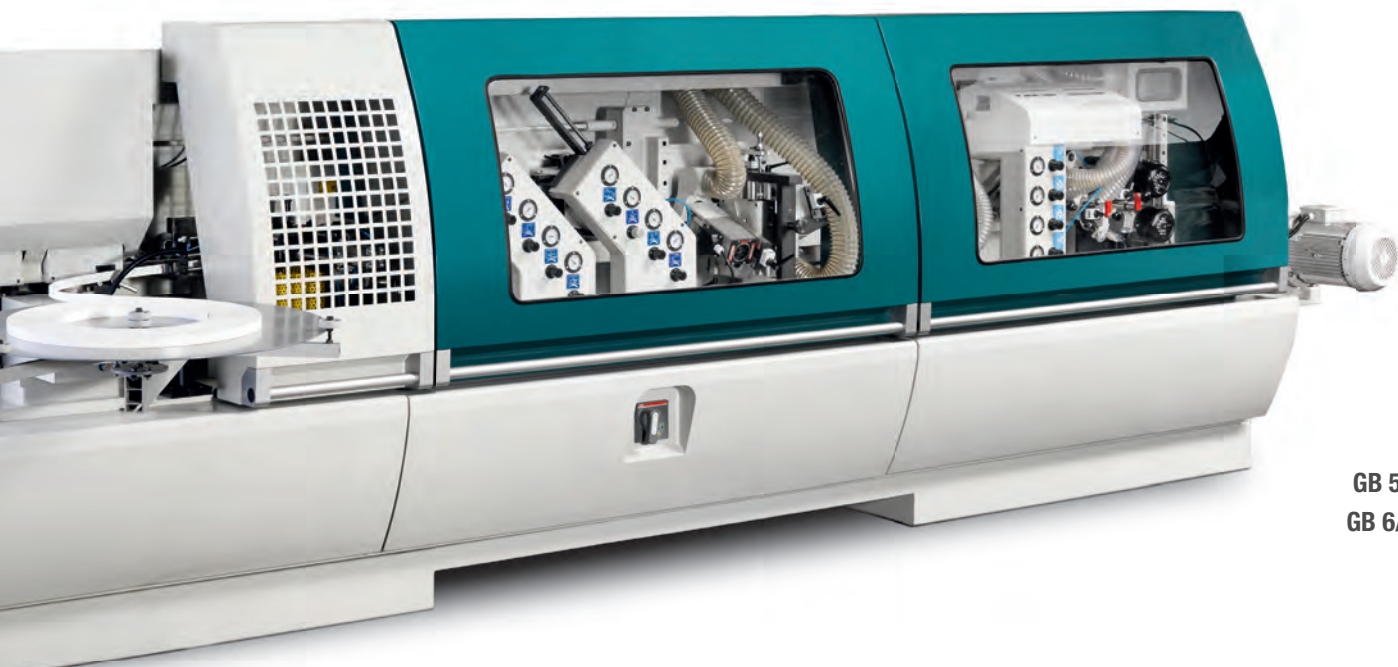

GB 5/8 RA
GB 6/15 RA



- Linea di montaggio e controllo qualità.
- *Montage et contrôle de qualité.*
- Línea de montaje y control cualidad.

GSV 13-14 GS 32E-42E



SEZIONATRICI VERTICALI / SCIÉS À PANNEAUX VERTICALES SECCIONADORAS VERTICALES



Standard

Spostamento manuale piano lavoro
Déplacement manuel superficie de travail
Desplazamiento manual mesa trabajo

GSV 13-14

con incisore (option)
avec graveur (option)
con incisor (a pedido)

GS32E-GS42E macchine complete di
Normativa CE

- Motore con trasmissione a cinghia
- Sistema di aspirazione con sacco
- Spostamento manuale del piano di lavoro con posizionamento a vista per evitare il contatto della lama con i listelli di appoggio, durante i tagli orizzontali
- Ruote alzabili per facilitare lo scorrimento dei pannelli
- Dispositivo per l'appoggio dei pezzi corti posizionato sul lato sinistro
- Asta metrica posizionata sul lato sinistro
- Pedale meccanico per il bloccaggio del montante

GSV 13 - GSV 14 macchine complete di:

- Normativa CE
- Motore con trasmissione a cinghia
- Sistema di aspirazione con sacco
- Armadio elettrico
- Spostamento manuale del piano di lavoro con arresto motore in automatico per evitare il contatto della lama con i listelli di appoggio, durante i tagli orizzontali
- Ruote alzabili per facilitare lo scorrimento dei pannelli
- Dispositivo per l'appoggio dei pezzi corti posizionato sul lato sinistro
- Asta metrica posizionata su tutta la lunghezza
- Pedale meccanico per il bloccaggio del montante
- Dispositivi pezzi corti lato destro

GS32E-GS42E machines complètes de:

- Normes CE
- Moteur de transmission à courroie
- Système d'aspiration avec sac
- Déplacement manuel de la table de travail avec positionnement à vue pour éviter le contact de la lame avec les barres d'appui pendant les coupes horizontales
- Roues qui montent pour aider le glissement des panneaux
- Dispositif pour l'appui des pièces courtes positionnées sur le côté gauche
- Tige métrique positionnée sur le côté gauche
- Pédale mécanique pour le blocage du montant

GSV 13 - GSV 14 machines complètes de:

- Normes CE
- Moteur avec transmission à courroie
- Système d'aspiration avec sac
- Boîte électrique
- Déplacement manuel de la table de travail avec arrêt moteur en automatique pour éviter le contact de la lame avec les barres d'appui pendant les coupes horizontales
- Roues qui montent pour aider le glissement des panneaux
- Dispositif pour l'appui des pièces courtes positionnées sur toute la longueur
- Tige métrique positionnée sur toute la longueur
- Pédale mécanique pour le blocage du montant
- Dispositifs pièces courtes côté droite

GS32E-GS42E máquinas completas de:

- Normativa CE
- Motor con transmisión a correa
- Sistema de aspiración con sacco
- Desplazamiento manual de la mesa de trabajo con posicionamiento a vista para evitar el contacto del disco con los listones de apoyo durante los cortes horizontales
- Ruedas levantables para facilitar el desplazamiento de los paneles
- Dispositivo para el apoyo de las piezas cortas en el lado izquierdo
- Asta métrica en el lado izquierdo
- Pedal mecánico para el bloqueo del montante

GSV 13 - GSV 14 máquinas completas de:

- Normativa CE
- Motor con transmisión a correa
- Sistema de aspiración con sacco
- Armario eléctrico
- Desplazamiento manual de la mesa de trabajo con parada del motor en automático para evitar el contacto del disco con los listones de apoyo durante los cortes horizontales
- Ruedas levantables para facilitar el desplazamiento de los paneles
- Dispositivo para el apoyo de las piezas cortas en el lado izquierdo
- Asta métrica en el lado izquierdo
- Pedal mecánico para el bloqueo del montante
- Dispositivos piezas cortas lado derecho

p 162

Dati tecnici

Données Techniques - Datos Tecnicos

		GS 32E GSV 13	GS 42E GSV 14
Massima altezza di taglio verticale Max. hauteur de coupe verticale Máxima altura de corte vertical	mm	1900	2200
Massima altezza di taglio orizzontale Max. hauteur de coupe horizontale Máxima altura de corte horizontal	mm	1700	2080
Massima lunghezza di taglio Max. longueur de coupe horizontale Máximo largo de corte	mm	3200	4200
Massimo spessore di taglio Max profondeur de coupe Máximo grueso de corte	mm	60	60
Potenza motore Puissance du moteur Potencia motor	KW(HP-CV)	3(4)	3(4)
Diametro della lama Diamètre de la lame Diámetro del disco	mm	250	250
Velocità di rotazione dell'albero Vitesses de rotation de l'arbre Velocidades de rotación del eje	g/1' t/1' r/1'	5300	5300



Incisore a lama
Graveur à lame
Incisor a disco



Incisore a coltelli
Graveur à couteaux
Incisor a cuchillas

GS 32/70 - GS 44/70 - GS 32/95 - GS 44/95

SEZIONATRICE ORIZZONTALE
SCIENS A RUBAN HORIZONTALES
SIERRA DE CINTA HORIZONTAL

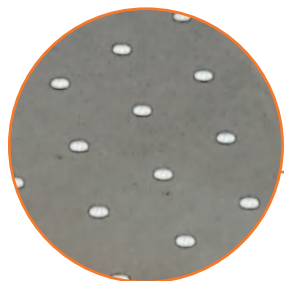

OPTION ②

CE



p 163



Dati tecnici

Données Techniques - Datos Técnicos

		GS 32/70	GS 38/70	GS 44/70	GS 32/95	GS 38/95	GS 44/95
Sporgenza lama MAX Saillie lame MAX Saliente máx. de la hoja	mm	70	70	70	95	95	95
Motore lama principale Puissance moteur lame principale Potencia motor hoja principal	Kw (HP)	5,5	5,5	5,5	7,5	7,5	7,5
Motore lama incisore Puissance moteur lame inciseur Potencia motor hoja incisor	Kw (HP)	1	1	1	1	1	1
Azionamento carro lame Actionnement chariot lames Accionamiento carro porta-hojas	STD OPT	inverter brushless	inverter brushless	inverter brushless	inverter brushless	inverter brushless	inverter brushless
Velocità avanzamento carro lame Vitesse de déplacement en avant du chariot lames Velocidad de avance del carro porta-hojas	STD OPT	3-70 1-20	3-70 1-20	3-70 1-20	3-70 1-20	3-70 1-20	3-70 1-20
Velocità ritorno carro lame Vitesse de retour du chariot lames Velocidad de retorno del carro porta-hojas	STD OPT	70 120	70 120	70 120	70 120	70 120	70 120
Azionamento spintore Actionnement pousseur Accionamiento empujador	STD OPT	inverter brushless	inverter brushless	inverter brushless	inverter brushless	inverter brushless	inverter brushless
Velocità avanzamento spintore Vitesse de déplacement du pousseur Velocidad de avance empujador	STD OPT	25-40 25-70	25-40 25-70	25-40 25-70	25-40 25-70	25-40 25-70	25-40 25-70
Tavoli Tables Mesas	N.	3	3	4	3	3	4

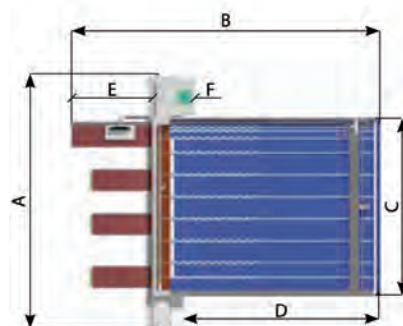

	3200	3800	4400
A	5700	6300	6900
B	6500	7200	7800
C	3600	4300	4900
D	3700	4400	5100
E	2000	2000	2000
F	1300	1300	1300



GS 44/95

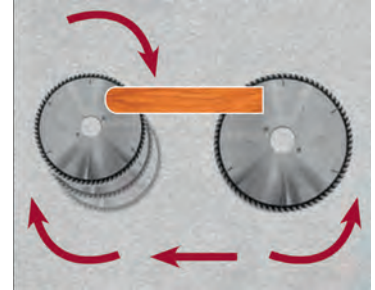

POST-FORMING

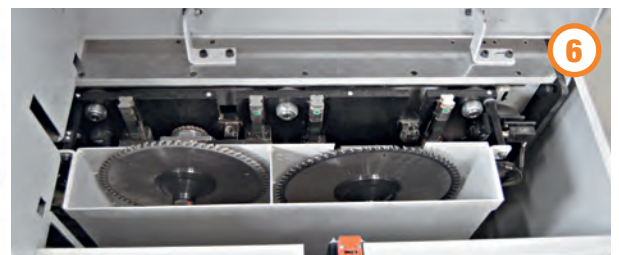
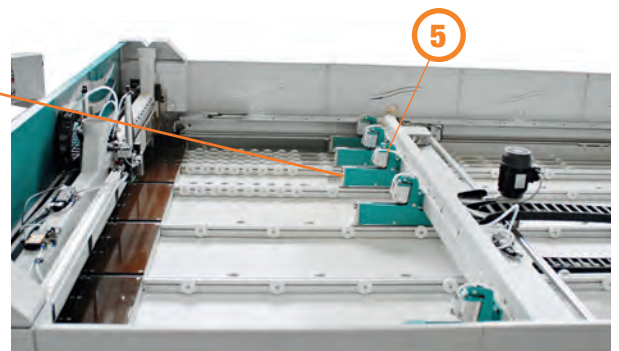
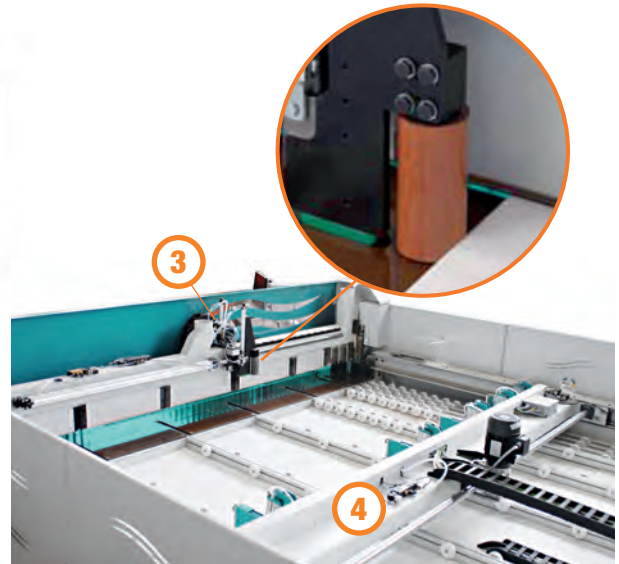

1) OPTION

Monitor LCD 15" (Touch screen)
 Monitor LCD 15" (Touch screen)
 Pantalla LCD 15" (Touch screen)

2) OPTION

Piani di lavoro (a velo d'aria)
 Tables d'appuie (a coussin d'air)
 Mesas de trabajo (con velo de aire)

3) Gruppo di allineamento laterale automatico
 Group de alignement laterale automatique
 Alineador lateral automático

4) Carro spintore motorizzato
 Pousseur
 Carro empujador motorizado

5) Pinze (GS 32 n.5 - GS 44 n.6)
 Pinces (GS 32 n.5 - GS 44 n.6)
 Pinzas (GS 32 n.5 - GS 44 n.6)

6) Carro lame
 Chariot lames
 Carro porta-sieras

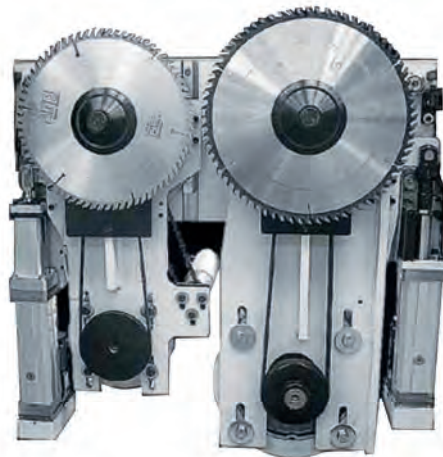

GAT 35 - GAM 10 - GAM 22-33 - 33AF

CENTRO DI LAVORO ANGOLARE PER SERRAMENTI
CENTRE DE TRAVAIL ANGULAIRE POUR BÂTIS
CENTRO DE TRABAJO ANGULAR PARA VENTANAS



GAM 10

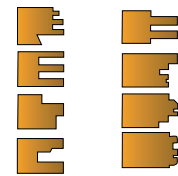
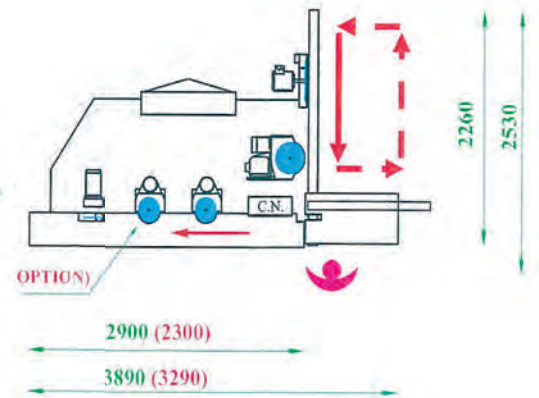

CE

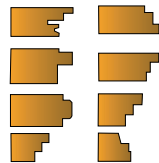

GAT 35



- GAM 22
- GAM 33
- GAM 33 AF

CENTRO DI LAVORO ANGOLARE PER SERRAMENTI

CENTRE DE TRAVAIL ANGULAIRE POUR BÂTIS

CENTRO DE TRABAJO ANGULAR PARA VENTANAS

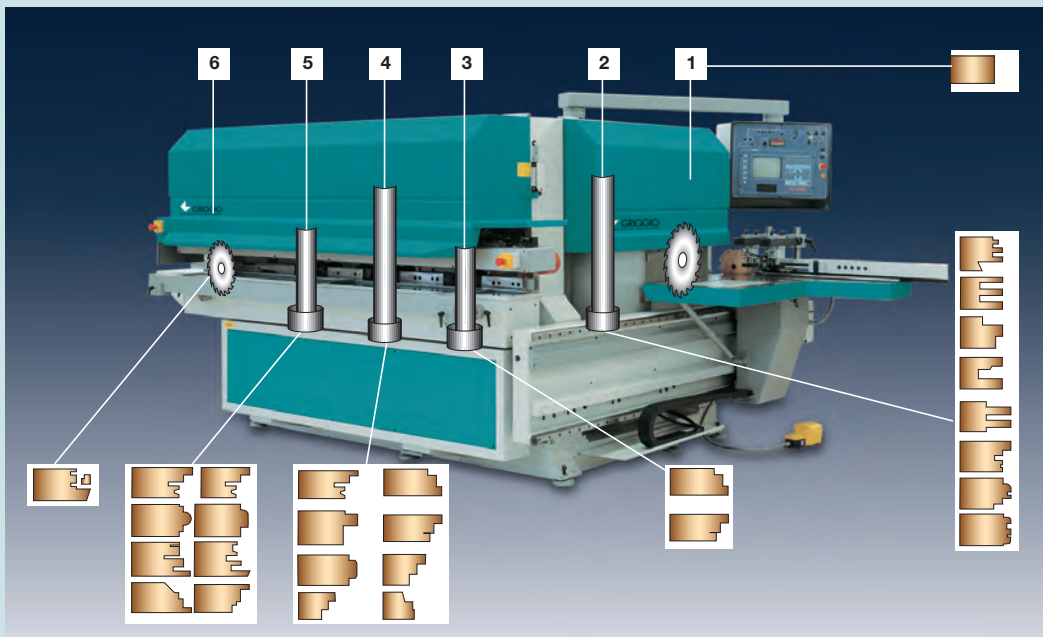

- 1 - gruppo sega circolare
 - 2 - albero per tenonare
 - 3 - albero profilatore antisceglia dx. sx.
 - 4 - albero per profilare
 - 5 - albero ferramenta
 - 6 - gruppo recupero listello
- attenzione: il 3° e 5° albero sono a richiesta

- 1 - groupe scie a format
 - 2 - arbre pour tenonner
 - 3 - arbre pour profiler para-eclat droite-gauche
 - 4 - arbre pour profiler
 - 5 - arbre outils
 - 6 - groupe recuperation latte
- attention: le 3ème et le 5ème arbres sont sur demande

- 1 - grupo sierra circular
 - 2 - eje para espigar
 - 3 - eje perfilador para-astillas derecha-izquierda
 - 4 - eje para perfilar
 - 5 - eje herramientas
 - 6 - grupo recuperacion liston
- ¡atencion! el 3º y el 5º eje son a pedido

p 163

Dati tecnici

Données Techniques - Datos Tecnicos

		GAM 10	GAM 22	GAM 33
GRUPPO SEGA GROUPE SCIE GRUPO SIERRA	1			
Potenza motore Puissance du moteur Potencia motor	KW (HP-CV)	3(4)	3(4)	3(4)
Diametro lama (a richiesta) Diamètre de la lame (sur demande) Diametro disco (a pedido)	mm	400(500)	400(500)	400(500)
Velocità rotazione lama Vitesse de rotation de la lame Velocidad rotación disco	g/1' t/1' r/1'	3000	3000	3000
Spostamento orizzontale lama Mouvement horizontal de la lame Desplazamiento horizontal disco	mm	100	100	100
Altezza max di lavoro Hauteur maxi de coupe Altura max de trabajo	mm	120	120(160)	120(160)
ALBERO PER TENONARE ARBRE À TENONNER EJE PARA ESPIGAR	2			
Lunghezza albero Longueur de l'arbre Largo del eje	mm	320	350(490)	490(620)
Velocità rotazione Vitesse de rotation Velocidad rotación	g/1' t/1' r/1'	3200	3200	3200
Potenza motore Puissance du moteur Potencia motor	KW (HP-CV)	5,5 (7,5)	7,5(10)	7,5(10)
Diametro utensile max. Diamètre maxi de l'outil Diametro herramientas max.	mm	320	320	320
CARRO PER TENONARE CHARIOT À TENONNER CARRO PARA ESPIGAR				
Dimensioni piano Dimension de la table Dimensiones del plano	mm	600x1000	600x1000	600x1000

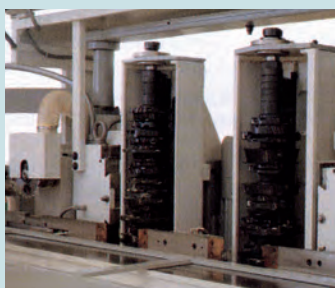

Alberi da 620 mm
Arbres de 620 mm
Ejes de 620 mm

Option

		GAM 10	GAM 22	GAM 33
ALBERO PER PROFILARE/ENTRATA A TEMPO ARBRE À PROFILER/ENTRÉE DANS LE BOIS PROGRAMMABLE EJE PARA PERFILAR/ENTRADA A TIEMPO	3	OPTION	OPTION	STANDARD
Lunghezza albero (a richiesta) Longueur de l'arbre (sur demande) Largo del eje (a pedido)	mm	100	100(160)	250(350)
Corsa orizzontale Course horizontale Recorrido horizontal	mm	70	70	70
Velocità rotazione Vitesse de rotation Velocidad rotación	g/1' t/1' r/1'	6000	6000	6000
Potenza motore Puissance du moteur Potencia motor	KW (HP-CV)	3(4)	3(4)	4(5,5)
Diametro dell'utensile Diamètre de l'outil Diametro de la herramienta	mm	220	220	220
ALBERO PER PROFILARE ARBRE À PROFILER EJE PARA PERFILAR	4			
Lunghezza albero Longueur de l'arbre Largo del eje	mm	320	350(480)	480(620)
Corsa verticale Course verticale Recorrido vertical	mm	250	350(480)	480(550)
Corsa orizzontale Course horizontale Recorrido horizontal	mm	70	70	70
Velocità rotazione Vitesse de rotation Velocidad rotación	g/1' t/1' r/1'	6000	6000	6000
Potenza motore standard Puissance du moteur Potencia motor	KW (HP-CV)	5,5(7,5)	7,5(10)	7,5(10)
Dimensioni piano Dimension de la table Dimensiones del plano	mm	220	220	220
GRUPPO RECUPERO LISTELLO GROUPE DE RÉCUPÉRATION DE LA PARCLOSE GRUPO RECUPERACION LISTON	6			
Potenza motore Puissance du moteur Potencia motor	KW (HP-CV)	2,2(3)	2,2(3)	2,2(3)
Diametro lama Diamètre de la lame Diametro disco	mm	200	200	200
Potenza motore traino Puissance du moteur d'entraine Potencia motor arrastre	KW (HP-CV)	1,1(1,5)	1,1(1,5)	1,1(1,5)



CNC 353 - 353N

CENTRI DI LAVORO CNC
 CENTRE DE TRAVAIL CNC
 CENTRO DE TRABAJO CNC



STANDARD

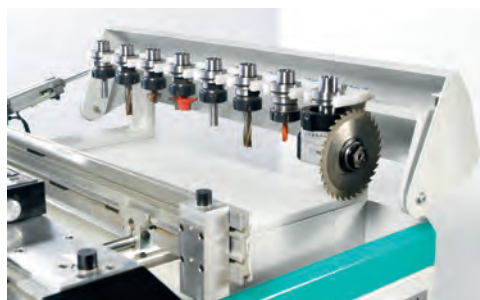

CNC 353
CNC 353/N

Magazzino a 8 postazioni
 Magasin à 8 postations
 Almacen a 8 posiciones

OPTION



HSK63
 Aggregati
 Incorporés
 Cabezas de
 trabajo



Lavorazioni di porte da interni
 Usinages de portes à l'intérieur
 Trabajos de puertas de interior

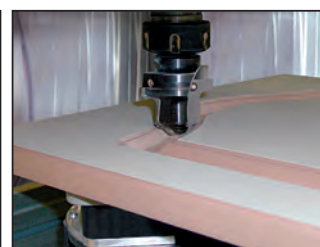

Lavorazioni di componenti del mobile
 Usinages de composants du meuble
 Trabajos de componentes del mueble



CNC 353 N



CNC 353

p 163

Dati tecnici

Données Techniques - Datos Técnicos

		CNC 353	CNC 353N
Dimensioni del piano di lavoro Dimensions de la table de travail Medidas de la mesa de trabajo	mm	3050x1250	3056x1256
Altezza di lavoro utile Hauter de travail utile Altura de trabajo útil	mm	80	80
Magazzino lineare a bordo trave 8 postazioni - HSK F63 Stock linéar à bord de la poutre 8 positions - HSK F63 Almacén lineal en el travesaño 8 posiciones - HSK F63	n.	1	1
Magazzino rotativo bordo testa BT 10 postazioni - HSK F63 Stock rotatif à bord de la tête BT 10 positions - HSK F63 Almacén rotativo canto cabeza BT 10 pos. - HSK F63	n.	-	-
1 Postazione a bordo trave per "Testina di lavoro" - HSK F6 1 Position à bord poutre pour "Tête de travail"-HSK F6 1 Posición en el travesaño para cabeza de trabajo - HSK F63	n.	1	-
Ventose SCHMALZ Ventouses SCHMALZ Ventosas SCHMALZ	n.	12	-
Filo "0" Fil "0" Filo "0"	n.	1 ant	1 ant
Piani di lavoro Tables de travail Mesas de trabajo	n.	6	-
Elettromandrino "SC" - 24000 RPM - HSK F63 Electromandrin "SC" -24000 RPM - HSK F63 Electromandril "SC" -24000 RPM - HSK F63	Kw	10,5	10,5

Option



OPTION



CNC 750

FORATRICE CNC PER PANNELLI
PERCEUSE CNC POUR PANNEAU
TALADRO CNC PARA PANELES



CE



- Bloccaggio pannello con pinza e pressolo frontale
- *Blocage du panneau avec pince et presseur frontal*
- Bloqueo panel con pinza y prensor frontal



- Testa a 4 mandrini con lama integrata
- *Tête à 4 mandrins avec lame intégrée*
- Cabeza a 4 mandriles con disco integrado

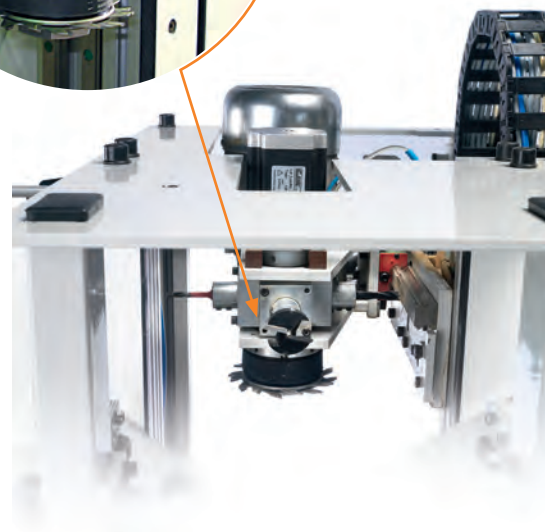

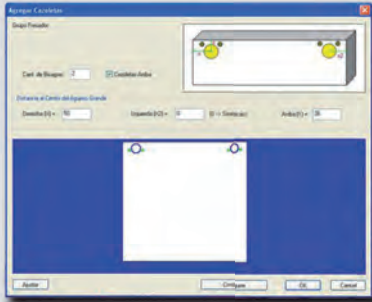

Esecuzione foratura cerniera
Réalisation trous charnière
 Exemplo de taladrado para bisagra

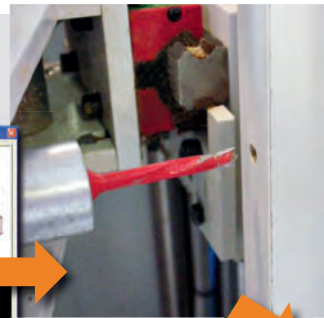
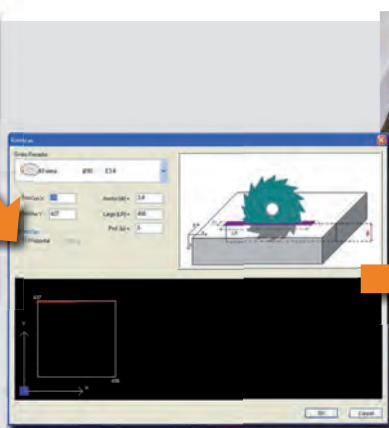
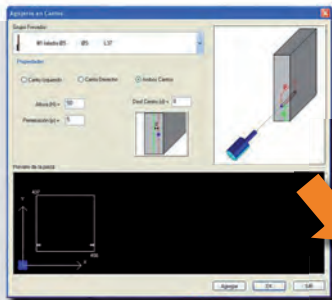

Foratura laterale e realizzazione della cava con lama
Perçage latérale et rainure réalisés avec lame
 Agujero lateral y ranura realizada con disco

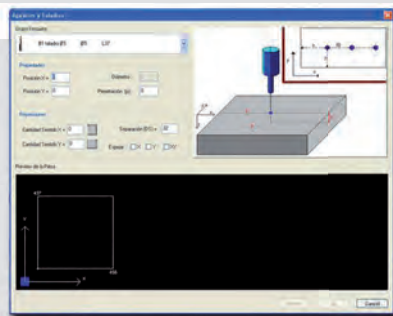

Programmazione della foratura
Programmation de perçage
 Programmacion para taladrar

PC OPERATIVO CON SISTEMA WINDOWS XP - SOFTWARE CAD PER LAVORAZIONE DEI PANNELLI / PC OPÉRATIF PAR SYSTÈME WINDOWS XP SOFTWARE CAD POUR USINAGE DES PANNEAUX VIS À RECERCLE DE BILLES POUR LES AXES X (VERTICAL) Y (HORIZONTAL) Z (PROFONDEUR) / PC OPERATIVO CON SISTEMA WINDOWS XP SOFTWARE CAD PARA TRABAJO DE TABLEROS TORNILLO A RECIRCULO DE BOLAS PARA EJES X (VERTICAL) Y (HORIZONTAL) Z (PROFUNDIDAD)

p 163



Dati tecnici

Données Techniques - Datos Tecnicos

CNC 750

Dimensioni utili lavoro del pannello / *Dimensions utiles d'usinage du panneau*
 Medidas util trabajo del panel

mm

750x2700x30

Asse Y (altezza) / *Axe Y (hauteur)* / Eje Y (altura)

mm

750

Asse X (lunghezza) / *Axe X (longueur)* / Eje X (largo)

mm

2700

Asse Z (spessore) / *Axe Z (épaisseur)* / Eje Z (espesor)

mm

30

Velocità degli alberi / *Vitesse des arbres* / Velocidad de los ejes

mt/1'

20

Profondità max cava con lama / *Profondeur maxi rainure de la lame*

Profundidad max ranura con disco

mm

10

Ø Fori / *Ø Trous* / Ø Agujeros

mm

3-5

Possibilità di forature per realizzare cerniera da cucina, configurabili con qualsiasi marca

Possibilité de percer pour exécuter charnière de cuisine, réalisable avec tout modèle

Possibilidad de taladrar para hacer bisagras de cocina, configurables con cualquier marca

Possibilità di foratura laterale / *Possibilité de percer latérale* / Posibilidad de taladrar lateralmente

Possibilità di realizzare cave con lama nel verso orizzontale (asse X), larghezza configurabile con software

Possibilité d'exécuter des rainures avec lame dans le sens horizontal (axe X), largeur réalisable avec software

Possibilidad de hacer ranuras con disco en el sentido horizontal (eje X), ancho configurable con software

Testa a 4 mandrini e lama integrata programmabile da computer

Tête à 4 mandrins et lame intégrée programmable du moniteur

Cabeza a 4 mandriles y disco integrado programable desde el ordenador

Vite a ricircolo di sfere per gli assi x (verticale) y (orizzontale) z (profondità)

Vis à recercle de billes pour les axes x (vertical) y (horizontal) z (profondeur)

Tornillo a recirculo de bolas para ejes x (vertical) y (horizontal) z (profundidad)



CNC 1000

FORATRICE CN A PANNELLO PASSANTE
 PERCEUSE CN A PANNEAU PASSANT
 CENTRO DE TRABAJO A TALADRAR CN CON PANEL PASANTE



STANDARD
 Touch Screen 7"



OPTION
 Touch Screen 15"



Esecuzione dei fori su 5 lati
Exécution des trous sur les 5 cotes
 Ejecucion de agujeros en 5 lados

Esecuzione dei fori per cerniere
Exécution des trous pour charnière
 Ejecucion de agujeros para

Fresatura con lama Ø 120 mm
Fraisage avec lame Ø 120 mm
 Fresatura con disco Ø 120 mm

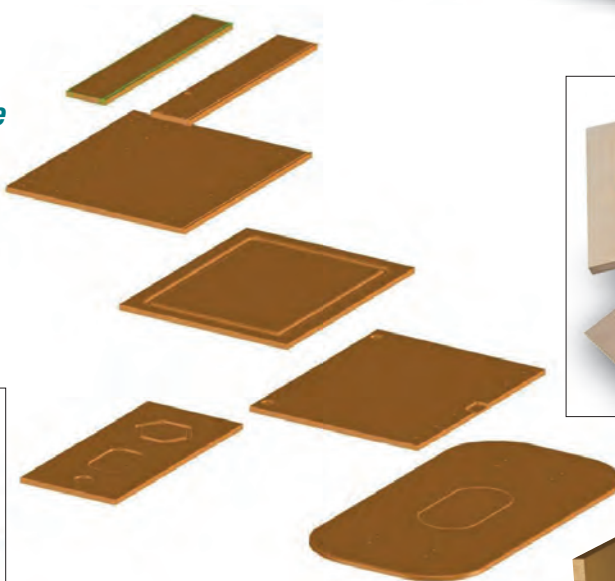

CNC 1000 new design

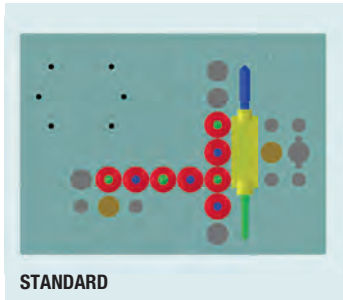
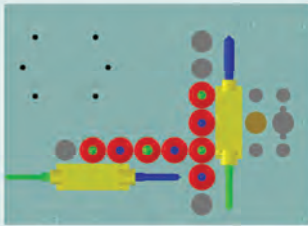
**STANDARD**
CONFIGURAZIONI OPZIONALI TESTA A FORARE / CONFIGURATIONS OPTIONNELLES TETE A PERCER / CONFIGURACION A PEDIDO CABEZA A TALADRAR
**OPTIONAL 1**

- 8 Mandrini verticali / 8 Mandrins verticaux / 8 Mandriles verticales
- 4 Mandrini orizzontali / 4 Mandrins horizontaux / 4 Mandriles horizontales

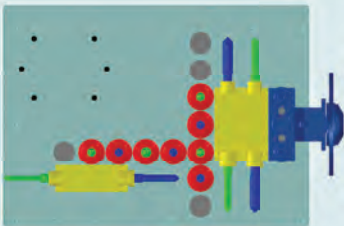
**OPTIONAL 2**

- 8 Mandrini verticali / 8 Mandrins verticaux / 8 Mandriles verticales
- 6 Mandrini orizzontali / 6 Mandrins horizontaux / 6 Mandriles horizontales
- Gruppo lama / Groupe lame / Grupo disco

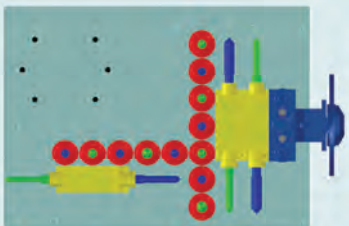
**OPTIONAL 3**

- 12 Mandrini verticali / 12 Mandrins verticaux / 12 Mandriles verticales
- 6 Mandrini orizzontali / 6 Mandrins horizontaux / 6 Mandriles horizontales
- Gruppo lama / Groupe lame / Grupo disco

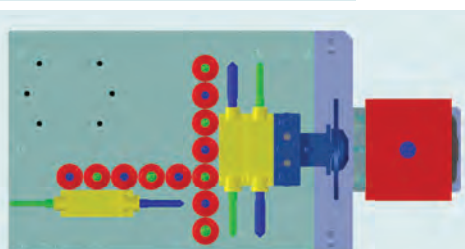
**OPTIONAL 3 CON TESTA A FORARE
OPTIONNEL 3 AVEC TETE A PERCER
A PEDIDO 3 CON CABEZA A FRESAR**

p 163

Dati tecnici

Données Techniques - Datos Técnicos

CNC 1000

Larghezza max pannello / Largeur maxime du panneau / Ancho max del panel	mm	1000
Spessore pannello / Épaisseur du panneau / Espesor panel	mm	8-60
Dimensioni minime del pannello / Dimensions minimum du panneau / Medidas minima del panel	mm	85x300
Dimensione lavoro asse Y / Dimensions du travail axe Y / Medida trabajo eje Y	mm	900
Dimensione lavoro asse X / Dimensions du travail axe X / Medida trabajo eje X	Illimitata / illimité / ilimitada	

TESTA A FORARE / TETE A PERCER / CABEZA A TALADRAR

Numero mandrini verticale / Numéro des mandrins verticaux / Numero de mandriles Verticales	n.	8
Numero mandrini orizzontale / Numéro des mandrins horizontaux / Numero de mandriles horizontales	n.	2
Interasse mandrini / Inter-axes des mandrins / Entrejes mandriles	mm	32
Corsa asse X / Course axe X / Recorrido eje X	mm	900
Corsa asse Y / Course axe Y / Recorrido eje Y	mm	1300
Corsa asse Z / Course axe Z / Recorrido eje Z	mm	70
Velocità di rapido asse X-Y / Vitesse de rapide axe X-Y / velocidad de rapido eje X-Y	m/min	60
Velocità di rapido asse Z / Vitesse de rapide axe Z / velocidad de rapido eje Z	m/min	20

Movimenti assi X-Y / Mouvements axes X-Y / Movimentos ejes X-Y

Cinghia dentata / Courroie dentée / Correa con dientes

Movimenti assi Z / Mouvements axes z / Movimentos ejes Z

Vite a ricricolo / Vis à recercle / Tornillo a ricriculo

Motori azionamenti / Moteurs actionnés / Motores accionados

Brushless

Numero pistoni pressore sezionato / Numéro des pistons presseur section / Numero de pistones seccionados

n. 3

Giri mandrini a forare / Tours des mandrins à percer / Giros mandriles a taladrar

g/1' 3150

Diametro max foratura / Diamètre maxi de perçage / Diametro max taladro

mm 35

Potenza motore testa a forare / Puissance moteur tête à percer / Potencia motor cabeza a taladrar

Hp (kw) 3 (2,2)

Parametrico / Paramétrique / Paramétrico

Ottimizzazione percorso di lavoro / Optimiser le parcours de travail / Optimizador recorrido de trabajo

Uscita USB / Sortie USB / Salida USB

Normativa CE / Normes CE / Normativa CE

TESTA A FRESARE / TETES A USINER / CABEZAS A FESAR

Giri mandrino a fresare / Tours du mandrin à usiner / Giro mandril a fresar	g/1'	0-24000
Ø max fresa / Ø maxi de l'outil / Ø max fresa	mm	20
Campo di lavoro mandrino a fresare / Champs de travail mandrin à usiner / Campo de trabajo mandril a fresar	mm	1000
Potenza a motore testa a fresare / Puissance moteur tête à percer / Potencia motor cabeza a fresar	Hp(Kw)	4,5 (3,3)

Windows XP

Parametrico / Paramétrique / Paramétrico

Ottimizzazione percorso di lavoro / Optimiser le parcours de travail / Optimizador recorrido de trabajo

Uscita USB / Sortie USB / Salida USB

Possibilità di installazione CAD / Possibilité d'installation CAD / Posibilidad de instalar CAD

Importazione disegni DXF / Importation des desseins DXF / Importacion diseños DXF

Possibilità di collegamento con PC ufficio / Possibilité de branchement par PC bureau / Posibilidad de conexión con PC oficina

Riconoscimento file ISO / Identification file ISO / Reconoscimento file ISO

Telesistenza / Téléassistance / Telesistencia

Normativa CE / Normes CE / Normativa CE





CNC 2100

CENTRI DI LAVORO CNC / *CENTRE DE TRAVAIL CNC* / CENTRO DE TRABAJO CNC



Per lavorazione porte interne, esterne, blindate e telai
Pour usinage des portes interne, extérieures, blindées et châssis
Para trabajo puertas interior, exterior blindadas y telar



Per lavorazione porte
Pour usinage des portes
Para trabajo puertas



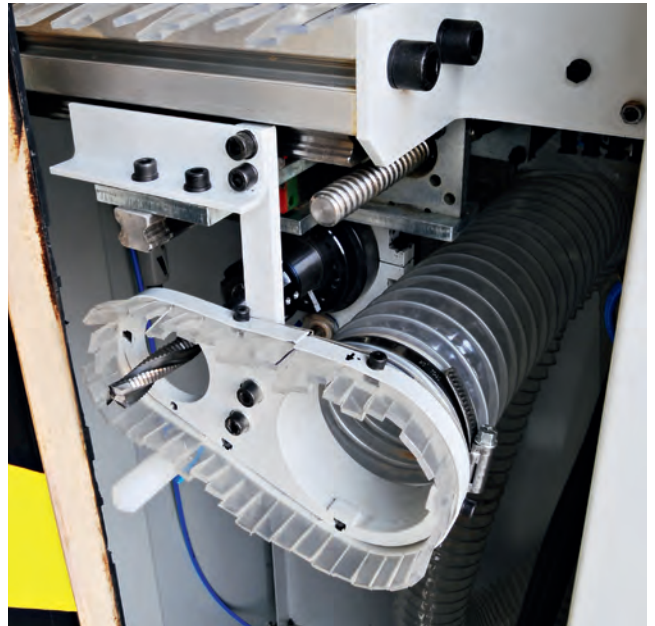

PC operativo con sistema Windows XP
Software CAD per eseguire serrature, cerniere, e fresature per maniglie. Vite a ricircolo di sfere assi y (orizzontale) z (profondità) Vite a cremagliera per l'asse x (verticale)

PC opératif par système Windows XP
Software cad pour usinages des portes, des portes blindées et des châssis. Vis à recercle de billes pour les axes y (horizontal) z (profondeur). Vis à crémaillère pour l'axe x (verticale)

PC operativo con sistema windows XP
Software cad para trabajo de puertas, puertas blindadas bastidores tornillo a recirculo de bolas para ejes y (horizontal) z (profundidad) tornillo a cremallera para eje x (vertical)



p 163



Dati tecnici

Données Techniques - Datos Tecnicos

CNC 2100

Asse X (Altezza) Asse X (Hauteur) Eje X (Altura)	mm	2100
Asse Y (Spessore) Asse Y (Epaisseur) Eje Y (Canto)	mm	50
Asse Z (Profondità) Asse Z (Profondeur) Eje Z (Profundidad)	mm	100
Velocità di movimento Vitesse de mouvement Velocidad de traslación	m/min	max 20
N.1 motore fresatore ad alta frequenza N.1 moteur à usiner à haute fréquence N. 1 motor fresador de alta frecuencia	rpm	18000 HP 1,5
Ø Cappa aspirazione Ø Buse d'aspiration Ø boca de aspiracion	mm	80



Ingombri e imballi
Encombremet et emballage
Embalaje y anclaje



Mod.	Foto Photo Foto	Peso netto Poids net Peso neto	Peso lordo in cassa Poids brut en caisse Peso bruto en caja de madera	Dimensioni d'ingombro Dimensions d'encombrement Dimensiones de embalaje	Dimensioni d'imballo Dimensions d'emballage Dimensiones de anclaje	Volume / Volumen	Ø bocche di aspirazione "CE" Ø bouche d'aspiration "CE" Ø boca de aspiración "CE"	Ø bocche di aspirazione "BASIC" Ø bouche d'aspiration "BASIC" Ø boca de aspiración "BASIC"
		Kg	Kg	mm	mm	m ³	mm	mm
FS 410		720	865	2100x1480x1070	2220x1100x1100	2,7	140	140*
FS 530		980	1080	2400x1600x1090	2500x1050x1100	2,9	140	140*
PSA 530		690	730	950x920x1250	1000x1000x1350	1,4	150	150
PSA 630 PSA 630 R		810	890	1150x1000x1150	1300x1100x1350	1,9	160	160*
PF 430		790	915	2750x600x1850	2800x850x1000	2,4	140	140*
PF 530 R PF 530		910	1060	2900x700x1850	3000x950x1000	2,9	140	140*
TS 150		680	950	1700x3000x1300	1900x1150x1100	2,4	1x60; 3X120	1x60; 2x120
TS 300		980	1150	3200x3000x1300	3400x1150x1100	5	1x60; 3X120	1x60; 2x120
TS 150-TS300 parallelogramma protecteur sur potence paralelograma		—	70	—	1700x800x200	2,7	—	—
SC 1400		450	520	2300x2750x1400	1900x1100x1100	2,3	1x60; 1x100	1x60; 1x100
SC 32		590	680	3300x3500x1400	3400x1200x1100	4,2	1x60; 1x100	1x60; 1x100
SC32 **		590	680	3300x3500x1400	2200x1250x1000 + (3400x350x150)	2,7 0,18	1x60; 1x100	1x60; 1x100
SC1400-SC32 con carro smontato avec chariot demonte con carro desmontado		—	70	—	1700x800x200	0,27	—	—
CA 40 PF		630	680	1700x1500x1750	1700x1100x1115	0,21	2X100	1x60; 1x100
CA 40		690	760	1700x3340x1750	2000x1200x1115	2,7	2x100	1x60; 1x100
CA 40 parallelogramma protecteur sur potence paralelograma		—	70	—	1700x800x200	0,27	—	—
UNICA 350		705	845	3300x3360x1750	3400x1200x1200	4,9	1x80 1x120	1x60 1x120
UNICA 350-315		705	845	3300x3360x1400	3400x1200x1200	4,9	1x60 1x120	1x60 1x120
UNICA 350 E		705	845	3300x3360x1750	3400x1200x1200	4,9	1x80 1x120	1x60 1x120
UNICA 350 UNICA 350 DIGIT 3 UNICA 350 EVO		840	1040	3300x3360x1750	3400x1200x1200 EVO 2000X300X300 DIGIT 2000X300X300	4,9 0,2	1x80 1x120	1x60 1x120
UNICA 350** con carro smontato avec chariot demonte con carro desmontado		840	845	—	2250X1200X1200 3400x400x200	3 0,27	—	—





















Mod.	Foto Photo Foto	Peso netto Poids net Peso neto	Peso lordo in cassa Poids brut en caisse Peso bruto en caja de madera	Dimensioni d'ingombro Dimensions d'encombrement Dimensiones de embalaje	Dimensioni d'imballo Dimensions d'emballage Dimensiones de anclaje	Volume / Volumen	Ø bocche di aspirazione "CE" Ø bouche d'aspiration "CE" Ø boca de aspiración "CE"	Ø bocche di aspirazione "BASIC" Ø bouche d'aspiration "BASIC" Ø boca de aspiración "BASIC"
		Kg	Kg	mm	mm	m ³	mm	mm
UNICA 400		860	1000	3300x3360x1750	3400x1200x1200	4,9	1x80 1x120	1x60;1x120
UNICA 400 E		860	1000	3300x3360x1750	3400x1200x1200	4,9	1x80 1x120	1x60;1x120
UNICA 400 DIGIT UNICA 400 EVO		1000	1200	3300x3930x1750	3400x1200x1200 +Digit (2000x300x300) +Evo (2000x300x300)	4,9 0,2	1x80 1x120	1x60;1x120
UNICA 400 PROGRAM		1100	1300	3300x4060x1750	3400x1200x1200 +Program (1900x1800x600)	4,6 0,2	1x80 1x120	1x80;1x120
UNICA 400** con carro smontato avec chariot demonte con carro desmontado		860	1020	—	2250x1200x1200 +(3400x400x200)	3,0 0,27	—	—
UNICA 400 parallelogramma protecteur sur potence paralelograma		820	950	—	1700x800x200	0,27	—	—
UNICA 500		900	1050	3300x3360x1750	3500x1200x1200	4,9	1x80; 1x120	1x60; 1x120
UNICA 500 E		900	1050	3300x3360x1750	3500x1200x1200	4,9	1x80; 1x100	1x60; 1x120
UNICA 500 DIGIT UNICA 500 EVO		1040	1240	3300x3930x1750	3500x1200x1200 +Digit (2000x300x300) +Evo	4,9 0,2	1x80; 1x120	1x60; 1x120
UNICA 500 PROGRAM		1210	1310	3300x4060x930	3400x1200x1200 +Program (1900x1800x600)	4,9 0,2	1x80; 1x120	1x80;1x120
UNICA 500** con carro smontato avec chariot demonte con carro desmontado		900	1070	—	2250x1200x1200 +(3500x400x200)	3,0 0,27	—	—
UNICA 350/400/500 parallelogramma protecteur sur potence paralelograma		—	70	—	1700x800x200	0,27	—	—
T 210		430	510	1200x700x1120	1300x850x1000	1,1	2x120	120
T 210-TC		450	510	1120x730x1170	1300x950x1000	1,4	2x120	120
T 210-TR		580	680	1410x1450x1120	1500x1550x1100	2,3	2x120	120
T 210-TPL		530	580	2550x800x1170	2750x950x1100	2,9	2x120	120
T 220 + DIGIT + HSK		530	680	1400x710x1200	1450x900x1100	1,5	2x120	120
T 220-TC + DIGIT + HSK		650	740	1400x800x1200	1450x900x1100	1,5	2x120	120

Mod.	Foto Photo Foto	Peso netto Poids net Peso neto	Peso lordo in cassa Poids brut en caisse Peso bruto en caja de madera	Dimensioni d'ingombro Dimensions d'encombrement Dimensiones de embalaje	Dimensioni d'imballo Dimensions d'emballage Dimensiones de anclaje	Volume / Volumen	Ø bocche di aspirazione "CE" Ø bouche d'aspiration "CE" Ø boca de aspiración "CE"	Ø bocche di aspirazione "BASIC" Ø bouche d'aspiration "BASIC" Ø boca de aspiración "BASIC"
		Kg	Kg	mm	mm	m ³	mm	mm
T 220-T + DIGIT + HSK		815	905	2550x1500x1200	1750x1100x1100	1,8	2x120	120
T220-TR + DIGIT + HSK		700	790	2550x1300x1200	1750x1100x1100	1,8	2x120	120
T 220-TR-PL + DIGIT + HSK		750	840	3200x1535x1200	2450x1600x1100	4,3	2x120	120
T 220 T-PL + DIGIT + HSK		865	955	3200x1735x1200	2450x1600x1100	4,3	2x120	120
T 220 TPL + DIGIT + HSK		670	760	2650x1400x1200	2700x900x1100	2,7	2x120	120
T 270 + DIGIT + HSK		670	875	1200x700x1200	1450x900x1100	1,5	2x120	120
T270-T + DIGIT + HSK		895	980	2550x1500x1200	2450x1600x1100	4,3	2x120	120
T 270 T-PL + DIGIT + HSK		945	1035	3200x1500x1200	2450x1600x1100	4,3	2x120	120
T 270 TPL + DIGIT + HSK		740	840	2500x1400x1200	2700x900x1100	2,7	2x120	120
T220/T270 + PENSILE + PROGRAM		690	810	1400x1200x1800	1450x1200x1800	3,1	2x120	120
T 45 I + DIGIT		580	660	1080x950x1200	1250x1200x1100	1,5	2X120	2x120
T 45 I-TR + DIGIT		730	830	2430x1150x1200	1550x1250x1100	2,1	2X120	2x120
T 45 I-TR-PL + DIGIT		850	980	3080x1770x1200	2250x1550x1100	4,3	2X120	2x120
T 45 I-TPL + DIGIT		670	800	2435x1570x1200	2400x1200x1100	2,1	2X120	2x120
T 45 I + DIGIT + PENSILE		730	850	1080x950x1700	1250x1350x1800	3	2x120	2x120
T 45 + DIGIT + HSK		920	1100	1400x1200x1200	1500x1350x1100	2,2	2X120	2x120
T45-T + DIGIT + HSK		1140	1230	2500x1520x1200	1700x1400x1100	2,7	2X120	2x120
T 45T-PL + DIGIT + HSK		1190	1280	3150x2120x1800	1700x1400x1100	2,7	2X120	2x120
T 45 TPL + DIGIT + HSK		1190	1300	2600x1820x1800	1700x1400x1100	2,7	2X120	2x120
T 45 + PENSILE + HSK DIGIT + PROGRAM		1190	1300	1400x1200x1800	1500x1400x1900	3,6	2x120	2x120

* A richiesta: non prevista di serie - ** se richiesto, scegliere soluzione: "imballo con carro smontato"









Mod.	Foto Photo Foto	Peso netto Poids net Peso neto	Peso lordo in cassa Poids brut en caisse Peso bruto en caja de madera	Dimensioni d'ingombro Dimensions d'encombrement Dimensiones de embalaje	Dimensioni d'imballo Dimensions d'emballage Dimensiones de anclaje	Volume / Volumen	Ø bocche di aspirazione "CE" Ø bouche d'aspiration "CE" Ø boca de aspiración "CE"	Ø bocche di aspirazione "BASIC" Ø bouche d'aspiration "BASIC" Ø boca de aspiración "BASIC"
		Kg	Kg	mm	mm	m ³	mm	mm
SNA 400		150	250	770x520x1790	1850x460x760	0,8	120	120
SNA 500		200	280	870x600x1970	1990x450x900	1,2	120	120
SNA 600		280	370	1000x790x2000	2140x510x1055	1,2	120	120
SNA 700		330	410	1180x800x2200	2290x510x1055	1,7	1x100;1x120	1x100;1x120
SNA 800		490	600	1280x850x2450	2590x530x1270	2,7	1x100;1x120	1x100;1x120
SNAC 540		240	320	870x620x1970	2070x520x940	1,1	120	120
SNAC 640		350	440	1050x720x2180	2280x550x1070	1,3	1x100;1x120	1x100;1x120
SNAC 740		450	540	1180x820x2430	2530x610x1200	1,9	1x100;1x120	1x100;1x120
SNAC 840		580	690	1410x920x2650	2750x680x1310	2,4	1x100;1x140	1x100;1x140
SNAC 940		700	810	1550x920x2900	3010x750x1450	3,3	1x100;1x140	1x100;1x140
SNAC 740R		670	760	1100x610x2430	2530x610x1200	1,9	1x100; 1x140	1x100; 1x140
SNAC 940R		990	1090	1350x1750x2910	3010x750x1450	3,3	1x100; 1x140	1x100; 1x140
SNAC 940RS		1030	1140	1500x1900x2900	3000x900x1600	4,3	1x100; 1x140	1x100; 1x140
RAC 235 refendino autocentrante entreneur autocentrant alimentador autocentrante		200	220	1300x540x350	1350x590x400	3,2	—	—
RA 21/RA 200/RA 250 refendino/entreneur/alimentador		185	205	1000x600x600	1050x650x600	4,1	—	—
SW 640/3200		1150	1450	3200x3300x2500	3250x1750x1500	8,5	2x120	2x120
SW 640/4300		1390	1790	4300x3300x2500	4500x1750x1500	11,8	2x120	2x120
S740/2 1500		720	850	1500x2500x2420	2430x800x1500	2,9	2x140	2x120
S740/2 3200		900	1050	3200x2500x2420	3200x800x1500	3,8	2x140	2x140
S740/3 1500		1010	1150	1500x2500x2420	2430x800x1500	2,9	2x140	2x120
S740/3 3200		840	1000	3200x2500x2420	2430x800x1500	3,8	2x140	2x120
TRC-N		260	300	1290x980x1270	680x980x1180	0,8	1x90	1x90
TRC-S		120	200	1100x900x1250	680x980x1180	0,8	1x80	1x80

Mod.	Foto Photo Foto	Peso netto Poids net Peso neto	Peso lordo in cassa Poids brut en caisse Peso bruto en caja de madera	Dimensioni d'ingombro Dimensions d'encombrement Dimensiones de embalaje	Dimensioni d'imballo Dimensions d'emballage Dimensiones de anclaje	Volume / Volumen	Ø bocche di aspirazione "CE" Ø bouche d'aspiration "CE" Ø boca de aspiración "CE"	Ø bocche di aspirazione "BASIC" Ø bouche d'aspiration "BASIC" Ø boca de aspiración "BASIC"
		Kg	Kg	mm	mm	m ³	mm	mm
GF21		250	350	1100x780x1300	1150x800x1100	1,1	—	—
GF23		290	360	1100x780x1300	1150x800x1100	1,1	—	—
GF27		300	390	1200x780x1300	1300x800x1100	1,3	—	—
GF35		330	500	1980x780x1300	1550x800x1100	1,8	—	—
G 65-5T		1100	1300	2600x1150x1500	2300x1250x1800	5,2	—	—
G 63-3T		750	930	2000x1000x1600	2100x1150x1500	3,6	—	—
G 60		290	360	1200x800x1900	1210x900x2000	2,2	80	80*
G 80		380	420	1300x800x1900	1310x900x2000	2,4	80	80*
G 90		450	480	1400x800x1900	1410x900x2000	2,5	80	80*
G 800		620	710	1500x1000x1800	1600x1100x1900	3,3	80	80*
G 900		1080	1150	1600x1000x1900	1700x1100x2000	3,4	80	80*
GAL-E		320	390	2800x750x1000	1900x800x1010	0,9	—	—
GAL-P		490	580	2900x1150x1200	1500x1100x1300	2,1	2x120	—
GT 4 S		600	690	1750x900x1300	1850x1000x1400	2,6	3x150	2x150
GAT 180		1200	1380	2300x1800x1700	2400x1900x1800	8,2	1x120;1x150	1x120;1x150
GAT 150-4		1700	1890	2300x1800x1700	2400x1900x1800	8,2	1x120;3x150	1x120;3x150
G 281		210	280	700x600x1650	800x600x2000	0,1	60	60
G 450		350	420	750x700x1700	800x600x2000	0,1	80	80
G 550 S		500	600	1000x800x2100	1000x1050x2150	2,3	80	80
GL 25		580	630	3500x1600x1400	2600x600x1200	1,8	100	100
GL 30		615	655	4000x1600x1400	3100x600x1200	1,8	100	100
S 220		80	130	1200x600x1000	1400x700x1100	1	80	80
GL 150		550	650	1440x1100x700	1550x1150x900	1,6	140	140













Mod.	Foto Photo Foto	Peso netto Poids net Peso neto	Peso lordo in cassa Poids brut en caisse Peso bruto en caja de madera	Dimensioni d'ingombro Dimensions d'encombrement Dimensiones de embalaje	Dimensioni d'imballo Dimensions d'emballage Dimensiones de anclaje	Volume / Volumen	Ø bocche di aspirazione "CE" Ø bouche d'aspiration "CE" Ø boca de aspiración "CE"	Ø bocche di aspirazione "BASIC" Ø bouche d'aspiration "BASIC" Ø boca de aspiración "BASIC"
		Kg	Kg	mm	mm	m ³	mm	mm
GL 200		580	680	1440x1100x700	1550x1150x900	1,6	140	140
GS 3		950	1100	3600x1200x2500	3700x1300x2600	12,5	—	—
GS A		1380	1500	3800x1200x2400	3900x1300x2550	12,9	—	—
GR 400		80	120	800x1050x1450	900x540x650	0,3	1x100;1x60	1x60
GR 640		180	220	1560x1400x1550	1400x850x530	0,6	1x100;1x60	1x60
GR 800		200	250	1860x1570x1550	1500x850x530	0,7	1x100;1x60	1x60
GR 960		270	340	2000x1740x1680	1500x1000x530	0,8	1x100;1x60	1x60
GR 1250		290	360	2000x2030x1680	1800x1000x1000	1,8	1x100;1x60	1x60
GM 4-34 Crociera di supporto / Support a croix Soporte a cruz		61	97 ...	470x900x750 740x300x300	530x530x330 0,2	0,1	—	—
GM 4-44 Crociera di supporto / Support a croix Soporte a cruz		62	98 ...	600x900x750 740x300x300	530x530x330 0,2	0,1	—	—
GA 4-38 Crociera di supporto / Support a croix Soporte a cruz		63	99 ...	470x900x750 740x300x300	530x530x330 0,2	0,1	—	—
GA 8-48 Crociera di supporto / Support a croix Soporte a cruz		67	103 ...	600x900x750 740x300x300	530x530x330 0,2	0,1	—	—
GA 8-68 Crociera di supporto / Support a croix Soporte a cruz		73	109 ...	900x900x750 740x300x300	1000x560x340 0,1	0,2	—	—
GV 3 Crociera di supporto / Support a croix Soporte a cruz		65	101 ...	500x900x750 700x300x300	670x570x330 0,1	0,1	—	—
GV 4		68	104 ...	600x900x750 700x300x300	670x570x330 0,1	0,1	—	—
GA 630		130	180	1000x540x1200	1100x650x1350	0,1	—	—
GA 850		160	220	1200x540x1200	1350x650x1350	1,2	—	—
GA U5		220	260	800x800x400	850x850x450	0,3	—	—
GA 600		70	90	600x500x400	650x550x450	0,2	—	—
GM 104 S		110	140	1600x900x700	1600x900x700	1	—	—

* A richiesta: non prevista di serie



Mod.	Foto Photo Foto	Peso netto Poids net Peso neto	Peso lordo in cassa Poids brut en caisse Peso bruto en caja de madera	Dimensioni d'ingombro Dimensions d'encombrement Dimensiones de embalaje	Dimensioni d'imballo Dimensions d'emballage Dimensiones de anclaje	Volume / Volumen	Ø bocche di aspirazione "CE" Ø bouche d'aspiration "CE" Ø boca de aspiración "CE"	Ø bocche di aspirazione "BASIC" Ø bouche d'aspiration "BASIC" Ø boca de aspiración "BASIC"
		Kg	Kg	mm	mm	m ³	mm	mm
GM 104 E		80	110	1600x900x700	1600x900x700	1	—	—
G 5-30		43	53	310x360x400	315x365x400	0,1	—	—
G 10-40		55	65	310x360x400	315x365x400	0,1	—	—
G 20-60		60	70	310x360x400	315x365x400	0,1	—	—
G 18Q - 22 Q		1220	1520	2900x1000x1500	3000x1100x1600	5,3	2x100x;2x120	2x100x;2x120
G230/4		1650	1750	3400x1400x1500	3500x1600x1600	8,9	4x120	4x120
G230/5U		1890	1990	4400x1500x1500	4500x1600x1600	10,8	5x120	5x120
G 240-4		2750	2900	3700x1700x1800	3800x1800x1900	13	4x150	4x150
G 240-5		3850	3980	3900x1700x1800	4000x1800x1900	13,7	5x150	5x150
G 240-6		4550	4780	4500x1700x1800	4600x1800x1900	15,7	6x150	6x150
G 240-5U		4050	4000	4600x1700x1800	4700x1800x1900	16,1	5x150	5x150
G 240-6U		4850	4950	5000x1700x1800	5100x1800x1900	17,5	6x150	6x150
G 240-7U		5500	5750	5800x1700x1800	5900x1800x1900	20,2	7x150	7x150
C 300		2300	2400	2100x1510x1510	2200x1610x1710	6,1	—	—
C 350		2700	2800	2340x1550x1510	2440x1650x1710	6,8	—	—
G66/10 T		2300	2400	3900x1750x1650	4000x1850x1750	12,2	—	—
GC 65-RT		850	1050	1350x1650x2025	1400x1700x2075	4,9	160	160
GC 65-RR		1000	1200	1350x1650x2025	1400x1700x2075	4,9	2x160	2x160
GC 65-RRT		1100	1300	1350x1650x2025	1400x1700x2075	4,9	2x160	2x160
GC 95/1-RT		1000	1200	1650x1650x2025	1700x1700x2075	5,9	160	160
GC 95/2-RR		1200	1400	1650x1650x2025	1700x1700x2075	5,9	2x160	2x160
GC 95/2-RRT		1300	1500	1650x1650x2025	1700x1700x2075	5,9	2x160	2x160
GC 110/1-RT		1200	1400	1800x1650x2075	1850x1700x2075	6,5	160	160

* A richiesta: non prevista di serie

Mod.	Foto Photo Foto	Peso netto Poids net Peso neto	Peso lordo in cassa Poids brut en caisse Peso bruto en caja de madera	Dimensioni d'ingombro Dimensions d'encombrement Dimensiones de embalaje	Dimensioni d'imballo Dimensions d'emballage Dimensiones de anclaje	Volume / Volumen	Ø bocche di aspirazione "CE" Ø bouche d'aspiration "CE" Ø boca de aspiración "CE"	Ø bocche di aspirazione "BASIC" Ø bouche d'aspiration "BASIC" Ø boca de aspiración "BASIC"
		Kg	Kg	mm	mm	m ³	mm	mm
GC 110/2-RR		1400	1600	1800x1650x2025	1850x1700x2075	6,5	2x160	2x160
GC 110/2-RRT		1500	1700	1800x1650x2025	1850x1700x2075	6,5	2x160	2x160
GI 1100 RT		1800	2000	1800x1800x2025	1850x1850x2075	7,1	2x160	2x160
GI 1300 RT		1900	2100	2045x1800x2025	2100x1850x2075	8	2x160	2x160
GI 1100 RR		1500	1700	1800x1650x2025	1850x1700x2075	6,5	2x160	2x160
GI 1300 RR		1600	1800	2056x1650x2025	2100x1700x2075	7,4	2x160	2x160
GI 1100 RRT		1800	2000	1800x1800x2025	1850x1850x2075	7,1	2x160	2x160
GI 1300 RRT		1900	2100	2056x1800x2025	2105x1850x2075	8	2x160	2x160
GI 1100 RRR		2400	2600	2050x1800x2025	2100x1850x2075	8	3x160	3x160
GI 1300 RRR		2500	2700	2056x2056x2025	2100x2100x2075	9,1	3x160	3x160
GI 1100 RRRT		2300	2500	2050x1800x2025	2100x1850x2075	8	3x160	3x160
GI 1300 RRRT		2400	2600	2050x2050x2025	2100x2100x2075	9,1	3x160	3x160
S 200/3 S 200/4		540 650	730 840	1500x1050x1500 1850x700x1500	1600x1150x1600 1950x800x1600	2,9 2,4	4x100 6x100	4x100 6x100
R 300/1 S 300/1		330	370	900x900x1300	1000x1000x1400	1,4	2x120	2x120
R 300/2 S 300/2		440	490	900x1300x1300	1000x1400x1400	1,9	2x120	2x120
R 600/2 S 600/2		750	790	1200x1300x1550	1300x1400x1650	3	2x140	2x140
R 800/2 S 800/2		830	870	1600x1300x1550	1700x1400x1650	6,1	2x140	2x140
R 300/4 S 300/4		920	1050	900x2200x1300	1000x2300x1400	1,9	2x120	2x120
R 600/4 S 600/4		1420	990	1960x2200x1550	1300x2300x1650	5,6	2x140	2x140
R 1300/2 S 1300/2		980	1030	1960x1370x1750	2060x1470x1850	5,6	2x140	2x120
S 1300 2RS		1300	1400	2100x1510x1510	2200x1610x1710	6,1	4x140	4x140
GP 20F		1000	1200	2900x1500x2000	3000x1600x2100	10,3	—	—



Mod.	Foto Photo Foto	Peso netto Poids net Peso neto	Peso lordo in cassa Poids brut en caisse Peso bruto en caja de madera	Dimensioni d'ingombro Dimensions d'encombrement Dimensiones de embalaje	Dimensioni d'imballo Dimensions d'emballage Dimensiones de anclaje	Volume / Volumen	Ø bocche di aspirazione "CE" Ø bouche d'aspiration "CE" Ø boca de aspiración "CE"	Ø bocche di aspirazione "BASIC" Ø bouche d'aspiration "BASIC" Ø boca de aspiración "BASIC"
		Kg	Kg	mm	mm	m ³	mm	mm
GP 30F		1100	1300	2900x1500x2000	3000x1600x2100	10,3	—	—
GP 30/3F		1250	1450	3400x1500x2000	3500x1600x2100	12	—	—
GP 40F		1300	1500	3050x1600x2000	3150x1700x2100	11,3	—	—
GP 40/3F		1500	1700	3550x1600x1800	3650x1700x1900	11,8	—	—
GP 40/S		1400	1600	3250x1600x1800	3350x1700x1900	10,7	—	—
GP 50/S		2300	2500	3100x1650x1800	3200x1750x1900	9,2	—	—
GP 60/S		2400	2600	3100x1650x1800	3200x1750x1900	9,2	—	—
GP 80 S		2800	3000	3100x1650x1800	3200x1750x1900	10,4	—	—
GP 85 S		3150	3350	3100x1650x1900	3200x1700x2000	10,8	—	—
GP 70 S		3000	3200	3600x1650x1800	3700x1750x1900	12,2	—	—
GP 100 S		3300	3500	3600x1650x1800	3700x1750x1900	12,2	—	—
GP 120 S		3600	3800	3600x1650x2000	3700x1700x2100	12,2	—	—
GP 90 S		4150	4390	4150x1650x2000	4250x1750x2100	15,7	—	—
GP 130 S		4700	4900	4150x1650x2100	4250x1750x2200	16,3	—	—
GP 150 S		5200	5400	4150x1650x2200	4250x1750x2300	17,1	—	—
G RR 300-2		270	320	1100x550x1300	600x1150x1450	1	—	—
G RR 800-2		340	390	1600x550x1300	600x1650x1450	1,4	—	—
G RR 1300-2		420	470	2100x550x1300	600x2150x1450	1,8	—	—
G RR 1600-2		510	560	2400x600x1300	650x2450x1450	2,3	—	—
G RR 1300-4		1050	1100	2100x900x1600	2150x950x1750	3,6	—	—
G RR 1400-4		1100	1150	2200x900x1600	2250x950x1750	3,7	—	—
G RR 1600-4		1400	1450	2400x900x1600	2450x950x1750	4,1	—	—
GPM 300		500	700	3100x1450x1600	3200x1550x1700	8,4	—	—



* A richiesta: non prevista di serie

Mod.	Foto Foto Foto	Peso netto Poids net Peso neto	Peso lordo in cassa Poids brut en caisse Peso. bruto en caja de madera	Dimensioni d'ingombro Dimensions d'encombremment Dimensiones de embalaje	Dimensioni d'imballo Dimensions d'emballage Dimensiones de anclaje	Volume / Volumen	Ø bocche di aspirazione "CE" Ø bouche d'aspiration "CE" Ø boca de aspiración "CE"	Ø bocche di aspirazione "BASIC" Ø bouche d'aspiration "BASIC" Ø boca de aspiración "BASIC"
		Kg	Kg	mm	mm	m ³	mm	mm
GB 60/10		220	260	1100x800x1100	1200x900x1200	1,2	—	—
GR 91 N		150	200	780x620x1370	785x625x1500	0,7	—	—
GRA		100	150	830x670x1250	835x675x1400	0,8	—	—
GB 2/3		680	850	2300x800x1600	2400x900x1000	3,4	1x50 1x100	1x50 1x100
GB 3/3		930	1120	2700x900x1500	2800x1000x1600	4,4	1x50 1x100	1x50 1x100
GB 4/3		980	1170	3050x900x1500	3150x1000x1600	5	1x50 1x100	1x50 1x100
GB 2/8		1080	1320	3200x1700x2100	3100x1070x1950	6,5	3x80	3x80
GB 4/8		1330	1630	4000x1700x2100	3900x1070x1950	7,8	4x80	4x80
GB 5/8 R		1610	1950	4400x1700x2100	4500x1070x1950	9,4	6x80	6x80
GB 5/15		1420	1730	4200x1900x2100	4000x1070x1950	8,3	6x80	6x80
GB 6/15 R		1700	1900	4750x1900x2100	4850x1070x1950	10	8x80	8x80
GB 4/8 A		1980	2180	4950x1700x2100	4850x1100x1950	10,4	6x20	6x80
GB 5/8 RA		2180	2380	5800x1900x2100	5900x1100x1950	12,6	8x80	8x80
GB 6/15 RA		2390	2590	6150x1900x2100	6250x1100x1950	13,4	10x80	10x80
GSV 25 E		650	730	3700x1450x2400	3770x2200x2000 +2900x1130x750	1,6 2,5	1x100	1x100
GSV 32 E		925	990	4400x1450x2400	4470x220x2000 +(2900x1130x750)	2 2,5	1x100	1x100
GSV 42E		1160	1230	5400x1450x2950	5470x220x2300 +(2900x1130x750)	2,8 2,5	1x100	1x100
GSV 13		945	1020	4400x1450x2400	4470x220x2000 +(2900x1130x750)	2 2,5	1x100	1x100



Mod.	Foto Foto Foto	Peso netto Poids net Peso neto	Peso lordo in cassa Poids brut en caisse Peso bruto en caja de madera	Dimensioni d'ingombro Dimensions d'encombrement Dimensiones de embalaje	Dimensioni d'imballo Dimensions d'emballage Dimensiones de anclaje	Volume / Volumen	Ø bocche di aspirazione "CE" Ø bouche d'aspiration "CE" Ø boca de aspiración "CE"	Ø bocche di aspirazione "BASIC" Ø bouche d'aspiration "BASIC" Ø boca de aspiración "BASIC"
		Kg	Kg	mm	mm	m ³	mm	mm
GSV 14		1120	1270	5400x1450x2950	5470x220x2300 +(2900x1130x750)	32,8 2,5	1x100	1x100
GS 32/70		3700	3800	5700x6500x1700	5700x1800x1800 4200x1000x1300	18,4 5,4	1x150 3x120	1x150 3x120
GS 38/70		4500	4600	6300x7200x1700	6400x1800x1800 4900x1100x1400	20,70 7,5	1x150 3x120	1x150 3x120
GS 44/70		5200	5300	7000x7800x1700	7000x1800x1800 5400x1000x1300	22,6 7	1x150 3x120	1x150 3x120
GS 32/95		3700	3800	5700x6500x1700	5700x1800x1800 4200x1000x1300	18,4 5,4	1x150 3x120	1x150 3x120
GS 38/95		4500	4600	6300x7200x1700	6400x1800x1800 4900x1100x1400	20,70 7,5	1x150 3x120	1x150 3x120
GS 44/95		5200	5300	7000x7600x1700	7000x1800x1800 5400x1000x1300	22,6 7	1x150 3x120	1x150 3x120
G AM 10		3000	3100	2400x3000x1700	2500x3100x1800	5,8	1x120 4x150 1x80	1x120 4x150 1x80
G AM 22		3200	—	3200x2300x2000	—	14,7	1x120;5x150 1x100;1x180	1x120;5x150 1x100;1x180
G AM 33		4100	—	3200x2400x2000	—	15,3	1x120;5x150 1x100;1x180	1x120;5x150 1x100;1x180
G AM 33 AF		5000	—	3200x2400x2000	—	15,3	1x120;5x150 1x100;1x180	1x120;5x150 1x100;1x180
CNC 353		2800	2850	5694x4145x2400	4700x2250x2200	23,2	1x200	1x200
CNC 353 N		2800	2850	5994x4045x2360	4700x2250x2200	23,2	1x200	1x200
CNC 750		370	570	3100x950x1700	3100x800x1800	4,4	2x100	2x100
CNC 1000		1500	1780	2300x1800x1600	2400x1900x1700	7,7	1x100	1x100
CNC 2100		280	410	800x800x2500	2600x900x900	2,1	1x80	1x80

* A richiesta: non prevista di serie

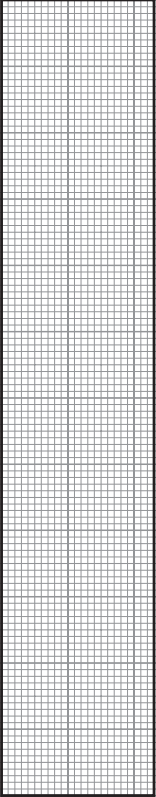
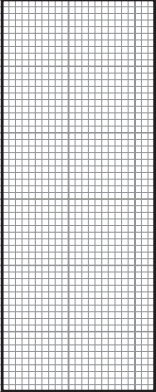
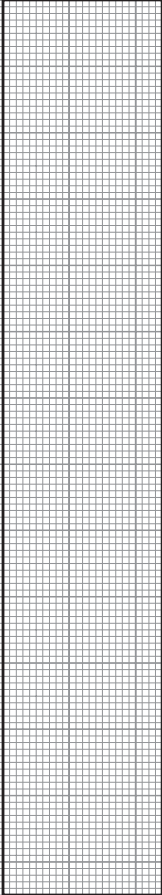
		
<p>BOX 40'' 12000x2300x2250 mm</p>	<p>BOX 20'' 5900x2300x2250 mm</p>	<p>TIR 13500x2400x2400 mm</p>
		

Scala / Echelle / Escala 1:100





LM 310 I - LM 410 I



LM30A



TS 30 I



SC 30 N



FS 31 - FS 41



PS 41



T 90 I



TA 120 - TA 150



AZ 60 - AZ 60/2



AZ 150



G /A1 - G/A2



FS 41 PLUS

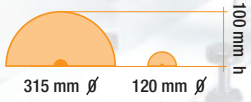

PS 43/53/63



PF 31/41/53

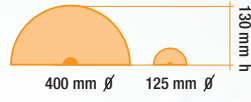

C 30



C 45



T 22



T 22 TR



T 45 S

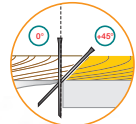

SN 40/50



GB/M



GRA/N

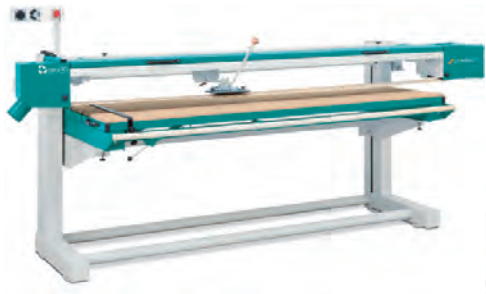

L 25/30



G/A1



G/A2

Standard



Standard

Spessore max pannello / Epaisseur maxi panneau / Espesor max panel	mm	40
Dimensione Bordo / Dimension du bord / Medida del canto	mm	0,4 - 3
Velocità avanzamento regolabile / Vitesse entrainement réglable / Velocidad avance regulable	m/1'	1 - 4
Capacità vasca colla / Capacité cuve colle / Capacidad calderin	ml	150
Motore Monofase / Moteur monophasé / motor monofasico	HP	0,25
Controllo elettronico temperatura min./max / Contrôle électronique température minimum/maxi / Control electronico temperatura min/max		120° - 220°

GB M

BORDATRICE MANUALE
PLAQUEUSE DE CHANTS MANUELLE
CHAPEADORA MANUAL



GRAVN

ARROTONDATORE PER ANGOLI E BORDI
ARRONDISSEUR POUR ANGLES ET CHANTS
REDONDEADOR PARA ANGULOS Y CANTOS

Standard

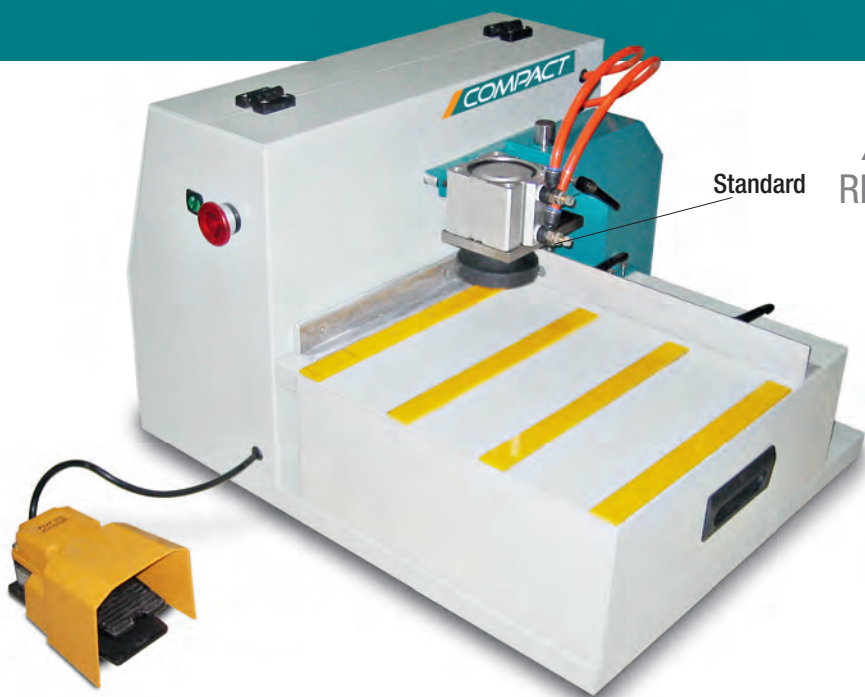

Velocità di rifilatura / vitesse d'affleurage / velocidad de refilador	rpm	24000
Spessore pannello / Epaisseur du panneau / Espesor panel	mm	10-55
Potenza motore / Puissance du moteur / Potencia motor	HP	0,5





SINCE 1946

GRIGGIO

WOODWORKING MACHINERY



MOSCOW



PADOVA



GRIGGIO S.p.A. Via Ca' Brion 40
P.o. Box 54 35011 RESCHIGLIANO (PD) - Italy
Tel. +39.049.929 9711 r.a. Fax +39.049.9201433
info@griggio.com - www.griggio.com

From VENICE	Km 35
From MILAN	Km 250
From ROME	Km 540



GRIGGIO S.p.A.
P.o. Box 54
Via Ca' Brion, 40
35011 RESCHIGLIANO (Padova) - ITALY

Tel. (+39) 049 9299711 r.a.
Fax (+39) 049 9201433
E-mail: info@griggio.com

www.griggio.com