

Suction Units / Dedusters series Vacomat



For mobile use in operational environments



Planning and implementation from a single source

Schuko is your expert in terms of extraction and filter technology, from advisory service, planning, production up to delivery, installation, commissioning, maintenance and operator training, everything is in our hands. – That is what we call service.

Another strength lies in the about 160 specialist workers in seven plants. For more than 45 years, the team of the owner-managed company has been manufacturing extraction and filter systems which are used in the processing of wood, paper and plastics. The customer base covers everyone from the craftsmen to mid-sized companies and large corporations.

As a member of the VDMA [Verband Deutscher Maschinen- und Anlagenbau e.V. (note of transl.: German Association of Machinery and Plant Manufacturers)], Schuko attaches great importance to system safety in compliance with the state of the art and the applicable standards. Many products have been approved by the respective employer's liability insurance associations [e.g. Holz-BG (note of transl.: German Wood Trade Association)], and now bear the GS symbol and the „dust-tested“ seal of approval.

The Schuko brand is a sign of performance and quality. Take our word for it and convince yourself.

Deduster - series Vacomat

Special device for the extraction of wood chips and dusts



Vacomat dust extraction units - an overview

Model	Art. No.	Drive motor 400 V, 50 Hz, 3 phase - [kW]	Intake Ø [mm]	Volum flow m³/h	Nominal volume flow [at 20m/s]	correspon- ding vacuum [PA]	Filter regeneration	Filter sur- face area [m²]	Dimensions L x W x H [mm]	Weight [kg]	Sound pressure level [dB(A)]
140/160 XP	621 500	2.2	140/160	1,593	1,447	2,200	pneumatic air required *: approx. 3.5 l at 6 bar	9.5	1,715 x 900 x 2,130	345	69
140/160 XPe	622 200	2.2	140/160	1,593	1,447	2,200	motor-controlled	9.5	1,715 x 900 x 2,130	319	69
180 XP	621 910	3.0	180	2,610	1,832	2,450	pneumatic air required *: approx. 3.5 l at 6 bar	13.5	2,085 x 900 x 2,130	414	72
180 XPe	621 950	3.0	180	2,610	1,832	2,450	motor-controlled	13.5	2,085 x 900 x 2,130	414	76
200 XP	621 800	3.7	200	2,495	2,262	2,800	pneumatic air required *: approx. 3.5 l at 6 bar	14.5	2,645 x 900 x 2,130	500	75
200 XPe	622 100	3.7	200	2,495	2,262	2,800	motor-controlled	14.5	2,645 x 900 x 2,130	500	75
250 XP	622 510	5.5	250	4,400	3,534	2,750	pneumatic air required *: approx. 3.5 l at 6 bar	32.0	3,650 x 1,540 x 2,570	962	70
300 XP	623 010	7.5	300	5,950	5,089	2,760	pneumatic air required *: approx. 3.5 l at 6 bar	32.0	3,650 x 1,540 x 2,570	967	74
350 XP	623 020	11	350	7,950	6,927	3,365	pneumatic air required *: approx. 3.5 l at 6 bar	50	3,800 x 1,550 x 2,660	1,070	70
350 XP TWIN	623 030	2 x 5.5	350	7,950	6,927	3,365	pneumatic air required *: approx. 3.5 l at 6 bar	50	3,900 x 1,620 x 2,660	1,160	68

* per cleaning cycle

Attention: with pulse-jet cleaning system: overall height H + 100 mm, length L + 350 mm

Small, space-saving entry-level models for single machine extraction

Vacomat XP

with pneumatic/mechanical filter cleaning
(compressed air required)

Model XPe

electro/mechanical filter cleaning
by means of an efficient shaker motor.



Key aspects / Features

The extraction devices of the Vacomat series have been especially developed by Schuko for mobile use in operational environments. The Vacomat enables the extraction of large quantities of dust and chips in a very small space. Depending on the requirements and needs, different models are available.

User-friendly cleaning (regeneration)

- The **designations XP and XPe** describe the type of filter regeneration. On the **Vacomat XP** models, the filter hoses are regenerated (cleaned) **pneumatically/mechanically** by means of a patented vibration via „shaking out“. A compressed air connection is required for this purpose (inlet pressure approx. 6 bar, operating pressure 4 bar, amount of air required per regeneration cycle approx. 3.5 l.).
- In contrast, the filters of the **Vacomat XPe** models are cleaned purely **electro/mechanically** by means of an efficient shaker motor. The control required for checking the potential-free contacts and for controlling the motor-operated vibration is included in the delivery. (Transducer coils are additionally available).
- **Pulse-jet cleaning system** (available as an optional extra)

Fast and easy commissioning:

The delivery includes:

- a model-specific switch cabinet
- two fixed rollers and two swiveling brakable castors
- 6 m of cable, plugs (16 ampère)
- integrated phase inverter
- one set of chip collection bags

Highlights

- **Time saving** due to independent monitoring of extraction performance
- High-efficiency **energy-saving motors** of the latest design, adapted to the performance level and „made in Germany“.
- **Investment reliability** due to latest technical development.
- **Optimum efficiency** due to powerful self-manufactured fans.
- **Individual, user-friendly positioning** in the workspace due to robust chassis with two fixed rollers and two brakable rollers.

1 Filter material

Consistent extraction performance

even at a high dust percentage due to filter hoses made of antistatic polyester needle felt (BGIA* tested). It is of particular advantage due to the fact that it prevents dusts from permanently adhering to the filters.

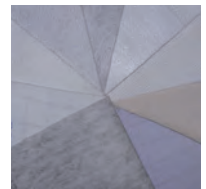

*German Professional Association for Industrial Safety (currently IFA: "Institute for Occupational Safety")

High-suction professional devices for challenging extraction jobs



Improved transport possibility
due to reduction in height

- 4** by 150 mm
- 5** by 170 mm
- 6** Transport height 1,960 mm
(the roof can be removed on site)

According to your needs - the optimum equipment

The Vacomat models of the 140/160, 180 and 350 series are equipped with the patented **Schuko Cone® filter hoses**. Compared to conventional filter hoses, they have 60% more filter area due to the fact that they are fitted with a double-walled filter layer.

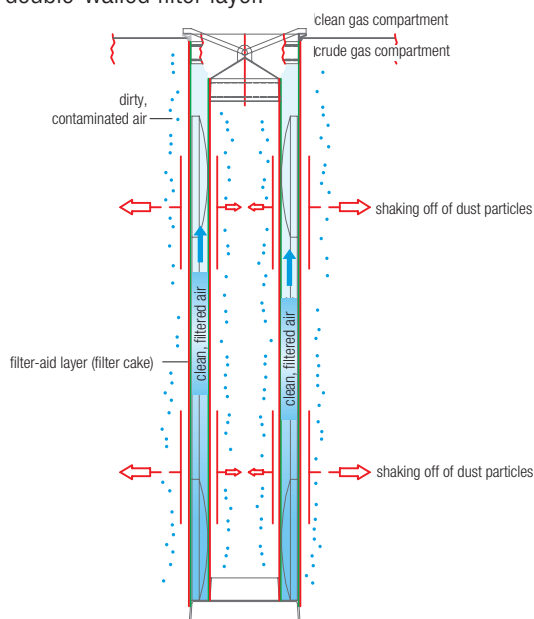

Discharge options

Chip collection containers, chip containers, cellular wheel sluice, inclined tube auger

2 Chip collection containers

- Adapted to individual needs, the number of chip collection containers depends on the extraction performance and the Vacomat model and varies between 1 and 4 containers with a capacity of 165 l each.
- **Easy disposal** of production residues (dust and chips) in dust-proof chip collection containers with inserted chip collection bag (diameter 770 mm, size V, art. no. 582 500).
- **Easy check of filling level** through an inspection glass.

3 Chip container 100/4/130 (optional)

- **Easy installation** for connection of a Compacto briquetting press
- **Reduction of volume** and pre-compaction for automatic discharge via cellular wheel sluice or auger.
- **Time saving** - no container change required for larger quantities of dust and chips.
- **Easy check of filling level** through an inspection flap.

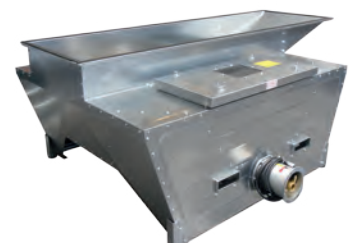



Quality and safety which pays off



Quality – Expertise and safety

With 160 employees in seven plants, Schuko as an owner-managed company has been manufacturing extraction and filter systems used in the processing of wood, paper and plastics for more than 45 years. The customer base covers everyone from the craftsmen to midsized companies and large corporations.

As a member of the VDMA (Verband Deutscher Maschinen- und Anlagenbau e.V. (note of transl.: German Association of Machinery and Plant Manufacturers)), we attach great importance to system safety in compliance with the current state of the art and the applicable standards.

Tested safety - for indoor installation

We herewith fulfil the insurance-law and occupational health and safety requirements of the employer's liability insurance association.

Clean air and < 0.1 mg/m³ of residual dust concentration -

The products bear the H3 mark of conformity and the GS symbol (tested safety).

Schuko with 7 production locations in Europe - always in the neighbourhood

Advisory service, planning, production, deliveries, installation, commissioning, maintenance, operator training and nationwide customer support for fast and qualified service.

Everything from a single source - That is what we call service.

**Unbeatable
extraction performance
in space-saving
design**



Vacomat 140/160 XP

Model XPe
with electro/mechanical filter
cleaning by means of an effi-
cient shaker motor.

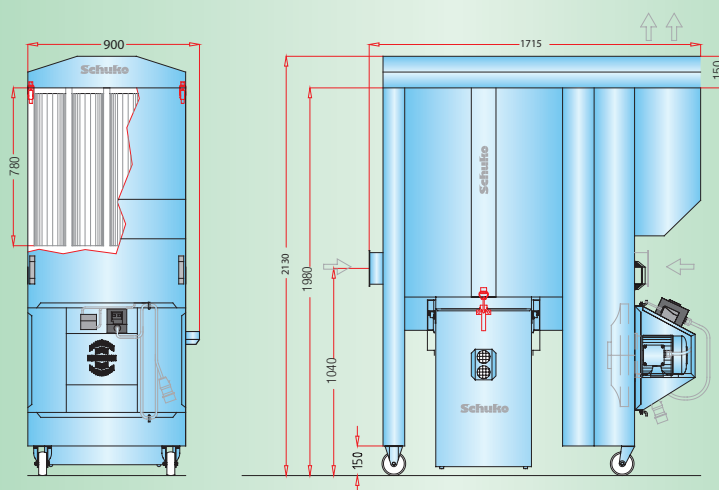

The Vacomat 140/160 XP and XPe with 1 chip collection container

Technical data Vacomat 140/160 XP and 140/160 XPe

Model	Art. No.	Drive motor 400 V, 50 Hz, 3 phase - [kW]	Intake Ø [mm]	Volum flow m ³ /h	Nominal volume flow [at 20m/s]	correspon- ding vacu- um [PA]	Filter regeneration	Filter sur- face area [m ²]	Dimensions L x W x H [mm]	Weight [kg]	Sound pressure level [dB(A)]
140/160 XP	621 500	2.2	140/160	1,593	1,447	2,200	pneumatic air required *: approx. 3.5 l at 6 bar	9.5	1,715 x 900 x 2,130	345	69
140/160 XPe	622 200	2.2	140/160	1,593	1,447	2,200	motor- controlled	9.5	1,715 x 900 x 2,130	319	69

* per cleaning cycle

Attention: with pulse-jet cleaning system: overall height H + 100 mm, length L + 350 mm

Top equipment:

- **consistent extraction performance** even at a high dust percentage due to Schuko Cone® filter hoses made of antistatic polyester needle felt (BGIA** tested)
- **patented Schuko Cone® filter hoses**, which, compared to conventional filter hoses, have 60% more filter area due to the fact that they are fitted with a double-walled filter layer
- **user-friendly operation** due to optionally pneumatic/mechanical regeneration on the Vacomat XP (compressed air required) or electro/mechanical regeneration by means of an efficient shaker motor on the Vacomat XPe
- **easy check of filling** level through inspection glass in the large chip collection container
- **energy-saving high-efficiency motor** „made in Germany“
- **easy disposal** of production residues by means of inserted chip collection bag size V (art. no. 582 500)
- **variation option** due to extraction nozzle with a diameter of 140 mm or 160 mm which can be optionally connected on the left-hand or right-hand side. The junction from the diameter of 160 mm to 140 mm will of course be included in the delivery.
- **optimum transport possibility** due to possible reduction in height by 150 mm
- **fast commissioning** as both Vacomat models are of plug-in design including 6 m of cable and are equipped with a phase inverter and a set of chip collection bags

**German Professional Association for Industrial Safety (currently IFA: "Institute for Occupational Safety")

Vacomat 180 XP

Model XPe

with electro/mechanical filter cleaning by means of an efficient shaker motor

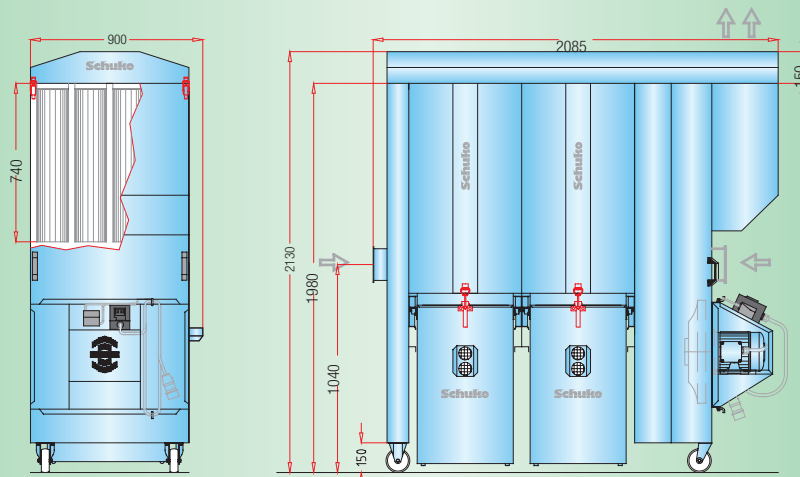
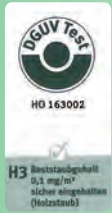

The Vacomat 180 XP and XPe with 2 chip collection containers

Technical data Vacomat 180 XP and 180 XPe

Model	Art. No.	Drive motor 400 V, 50 Hz, 3 phase - [kW]	Intake Ø [mm]	Volum flow m ³ /h	Nominal volume flow [at 20m/s]	correspon- ding vacu- um [PA]	Filter regeneration	Filter sur- face area [m ²]	Dimensions L x W x H [mm]	Weight [kg]	Sound pressure level [dB(A)]
180 XP	621 910	3.0	180	2,610	1,832	2,450	pneumatic air required *: approx. 3.5 l at 6 bar	13.5	2,085 x 900 x 2,130	414	72
180 XPe	621 950	3.0	180	2,610	1,832	2,450	motor-controlled	13.5	2,085 x 900 x 2,130	414	76

* per cleaning cycle

Attention: with pulse-jet cleaning system: overall height H + 100 mm, length L + 350 mm

Top equipment:

- **patented Schuko Cone® filter hoses** made of anti-static polyester needle felt (BGIA** tested), which, compared to conventional filter hoses, have 60% more filter area and are fitted with a double-walled filter layer
- **user-friendly operation** due to optionally pneumatic/mechanical regeneration on the Vacomat XP (compressed air required) or electro/mechanical regeneration by means of an efficient shaker motor on the Vacomat XPe
- **variation option** due to extraction nozzle which can be optionally connected on the left-hand or right-hand side
- **energy-saving high-efficiency motor** „made in Germany“
- pressure monitoring of the volume flow rate for **trouble-free extraction**
- **easy check of filling level** through inspection glass in the two large chip collection containers
- **easy disposal** of production residues by means of inserted chip collection bags size V (diameter 770 mm, art. no. 582 500)
- **optimum transport possibility** due to possible reduction in height by 150 mm
- **fast commissioning.** Both Vacomat models are of plug-in design including 6 m of cable and are equipped with an integrated phase inverter and a set of spare chip collection bags.
- **best results in case of CFK, GFK and plaster dusts** are ensured by the Vacomat 180 XP/S model with 2 filter cartridges and a filter area of 60 m² (art. no. 621 960)

Accessories (available as an optional extra)

- **pulse-jet cleaning system**

**German Professional Association for Industrial Safety (currently IFA: "Institute for Occupational Safety")



Vacomat 200 XP

Model XPe

electro/mechanical
filter cleaning by means
of an efficient shaker motor

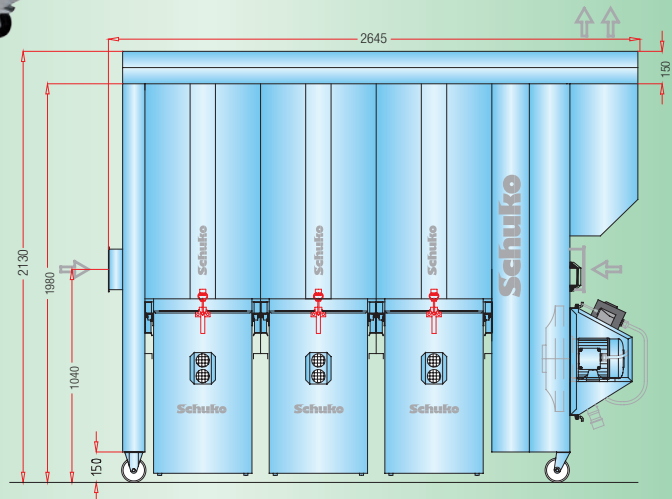
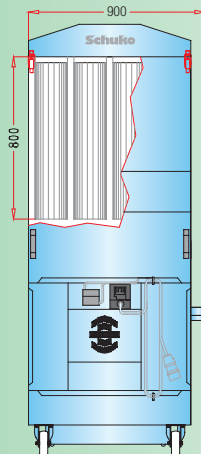
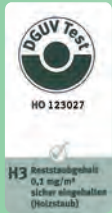

The Vacomat 200 XP and XPe with 3 chip collection containers

Technical data Vacomat 200 XP and 200 XPe

Model	Art. No.	Drive motor 400 V, 50 Hz, 3 phase - [kW]	Intake Ø [mm]	Volum flow m ³ /h	Nominal volume flow [at 20m/s]	correspon- ding vacuum [PA]	Filter regeneration	Filter sur- face area [m ²]	Dimensions L x W x H [mm]	Weight [kg]	Sound pres- sure level [dB(A)]
200 XP	621 800	3.7	200	2,495	2,262	2,800	pneumatic air required *: approx. 3.5 l at 6 bar	14.5	2,645 x 900 x 2,130	500	75
200 XPe	622 100	3.7	200	2,495	2,262	2,800	motor-controlled	14.5	2,645 x 900 x 2,130	500	75

* per cleaning cycle

Attention: with pulse-jet cleaning system: overall height H + 100 mm, length L + 350 mm

Top equipment:

- **improved extraction performance** due to highly-efficient fan on the clean air side
- **variation option** due to extraction nozzle which can be optionally connected on the left-hand or right-hand side
- **consistent extraction performance** even at a high dust percentage due to durable filter hoses made of anti-static polyester needle felt (BGIA** tested) preventing permanent adherence of dusts
- **user-friendly operation** due to optionally pneumatic/mechanical regeneration on the Vacomat XP (compressed air required) or electro/mechanical regeneration by means of an efficient shaker motor on the Vacomat XPe
- **easy check of filling level** through inspection glass in the three large chip collection containers
- **energy-saving high-efficiency motor** „made in Germany“
- **easy disposal** of production residues by means of inserted chip collection bags size V Ø 770 mm (art. no. 582 500)
- pressure monitoring of the volume flow rate for trouble-free extraction
- **optimum transport possibility** due to possible reduction in height (150 mm)
- **fast commissioning** as both Vacomat models are of plug-in design including 6 m of cable and are equipped with an integrated phase inverter and a set of chip collection bags

Accessories (available as an optional extra)

- **Compacto briquetting press**
- **Chip container SPB 100/3/130** (capacity 1 m³)

** German Professional Association for Industrial Safety (currently IFA: "Institute for Occupational Safety")

Vacomat 250 XP and 300 XP



The mobile giants - Vacomat 250 XP and 300 XP

Technical data Vacomat 250 XP and 300 XP

Model	Art. No.	Drive motor 400 V, 50 Hz, 3 phase - [kW]	Intake Ø [mm]	Volum flow m³/h	Nominal volume flow [at 20m/s]	correspon- ding vacuum [PA]	Filter regeneration	Filter sur- face area [m²]	Dimensions L x W x H [mm]	Weight [kg]	Sound pressure level [dB(A)]
250 XP	622 510	5.5	250	4,400	3,534	2,750	pneumatic air required *: approx. 3.5 l at 6 bar	32.0	3,650 x 1,540 x 2,570	962	70
300 XP	623 010	7.5	300	5,950	5,089	2,760	pneumatic air required *: approx. 3.5 l at 6 bar	32.0	3,650 x 1,540 x 2,570	967	74

* per cleaning cycle

Attention: with pulse-jet cleaning system: overall height H + 100 mm, length L + 350 mm

The Vacomat models 250 XP and 300 XP are identical in design. They only have different intake ports and fan performances. The standard inlet side is on the right, but also optionally possible on the left.

Top equipment:

- **longer service life of deduster** due to a large settling chamber (low material load for filter medium)
- **low-noise operation** due to double-walled filter hose lining 70 / 74 dB(A)
- **easy check of filling level** through inspection glass in the four large chip collection containers
- **easy disposal** of production residues by means of inserted chip collection bags size V Ø 770 mm (art. no. 582 500)
- **user-friendly operation** due to automatically initiated filter regeneration (pneumatic/mechanical)
- **time saving** due to independent monitoring of extraction performance by means of a pressure cell with signal lamp
- **consistent extraction performance** even at a high dust percentage due to durable filter hoses made of antistatic polyester needle felt (BGIA** tested)
- **increased safety due to automatic extinguishing system** in compliance with GS-HO-07, with powder extinguisher (no water damage)
- **optimum transport possibilities** due to reduction in height (170 mm)
- **energy-saving high-efficiency motor** „made in Germany“

**German Professional Association for Industrial Safety (currently IFA: "Institute for Occupational Safety")

Vacomat 250 XP and 300 XP

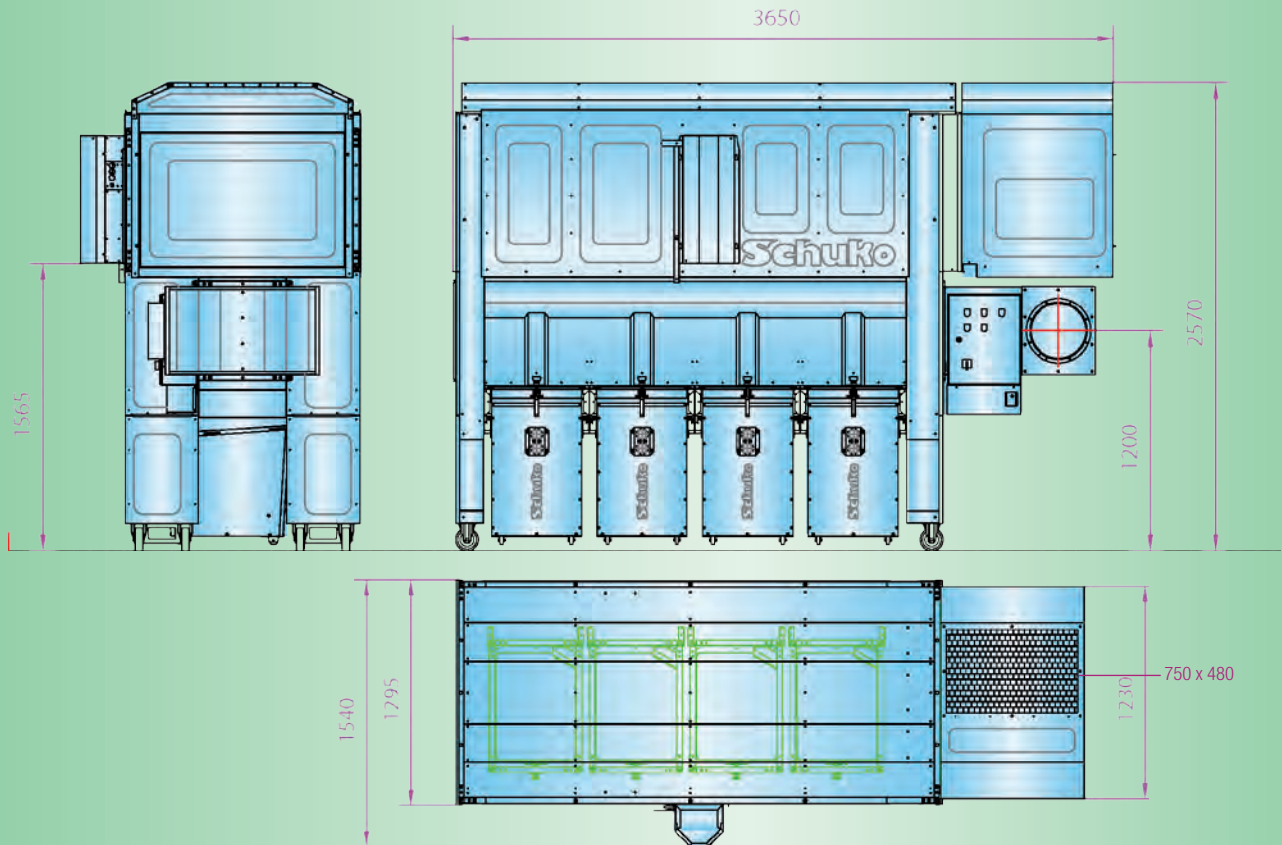

Vacomat 250 XP and 300 XP
with lateral left-hand auger discharge
for variable container filling (optional)

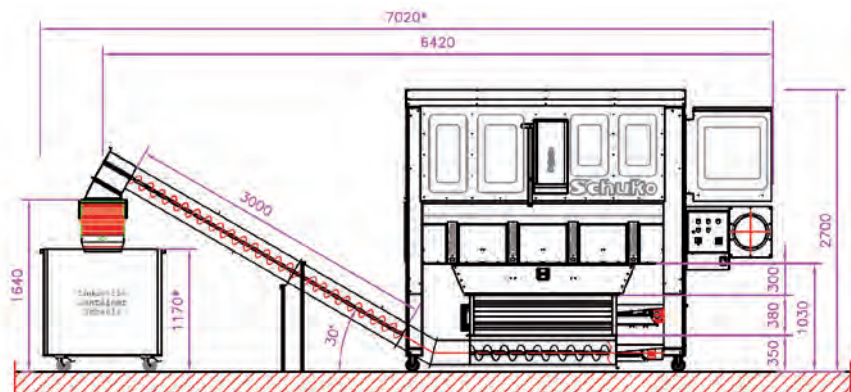

Switch cabinet design (included in the Vacomat basic price)

Automatic switch cabinet model V 22/23 (for Vacomat 5.5 / 7.5 kW)

autom. fan start upon start of up to 8 processing machines, autom. filter regeneration

Art. No.

(887 550)
incl.

Accessories (available as an optional extra)

- **additional control unit for V22/23/24**, for activating a maximum of 8 pneum. or motor-operated valves 888 600
- **additional control unit for V22/23/24**, for activating a maximum of 8 pneum. or motor-operated valves, with run time addition 888 650
- **activating system for pulse-jet cleaning**, for Vacomat 250/300/350 XP 889 070
- **pulse-jet cleaning system** for improved filter regeneration (plus 350 mm in length and 100 mm in height) 625 300
- **cellular wheel sluice** model ZRS 10, ATEX tested 1,400 x 260 mm (attention: overall height + 150 mm) 710 820
- **shaft** at cellular wheel sluice 1,400 x 260 mm 823 050
- **inclined tube auger** for installation under ZRS 1,400 x 260 mm 623 060
- **chip container SPB 100/4/130** (capacity 1m³) 750 130
- prepared for various **Compacto briquetting presses** ---

Attention: For processing reasons, even filling of the chip collection bags is often not possible.

Vacomat 350 XP and 350 XP TWIN with 2 x 5.5 kW



This **high-end model** with a connection diameter von 350 mm at a max. volume flow rate of 7,950 m³/h can exhaust **several individual machines** at the same time or even large **CNC production machines**.

now
Vacomat 350 XP and TWIN
 Top-quality dedusters

Vacomat 350 XP / TWIN - especially for most challenging extraction jobs directly where needed (PoD point of dust)

Technical data 350 XP and 350 XP TWIN

Model	Art. No.	Drive motor 400 V, 50 Hz, 3 phase - [kW]	Intake Ø [mm]	Volum flow m ³ /h	Nominal volume flow [at 20m/s]	correspon- ding vacuum [PA]	Filter regeneration	Filter sur- face area [m ²]	Dimensions L x W x H [mm]	Weight [kg]	Sound pressure level [dB(A)]
350 XP	623 020	11	350	7,950	6,927	3,365	pneumatic air required *: approx. 3.5 l at 6 bar	50	3,800 x 1,550 x 2,660	1,070	70
350 XP TWIN	623 030	2 x 5.5							3,900 x 1,620 x 2,660	1,160	68

* per cleaning cycle

Attention: with pulse-jet cleaning system: overall height H + 100 mm, length L + 350 mm

Top equipment / Proven technology

- **consistent extraction performance even at a high dust percentage** due to durable filter hoses made of antistatic polyester needle felt of dust class M (BGIA** tested)
- **longer service life of deduster** due to an increased filter area and a large settling chamber (low amount of material settling on the filter medium)
- **user-friendly operation** due to automatically initiated pneumatic-mechanical filter regeneration. Pulse-jet cleaning system available as an optional extra
- **short pipe laying routes** and thus low flow resistances
- **easy check of chip filling level** through inspection glass in the four large, mobile chip collection containers
- **automatic switch cabinet with intelligent control** for automatic fan start upon start of up to 8 machines via transducer coil or potential-free contact
- **easy-to-maintain operation** due to independent monitoring of extraction performance and display of the current soiling degree (pressure cell with signal lamp)
- **space-saving compact design**, also approved for indoor installation (dependent on chip material)
- **improved transport possibility** due to a reduction in height to 2,210 mm. Transport height 1,960 mm (the roof can be removed on site)

**German Professional Association for Industrial Safety (currently IFA: "Institute for Occupational Safety")

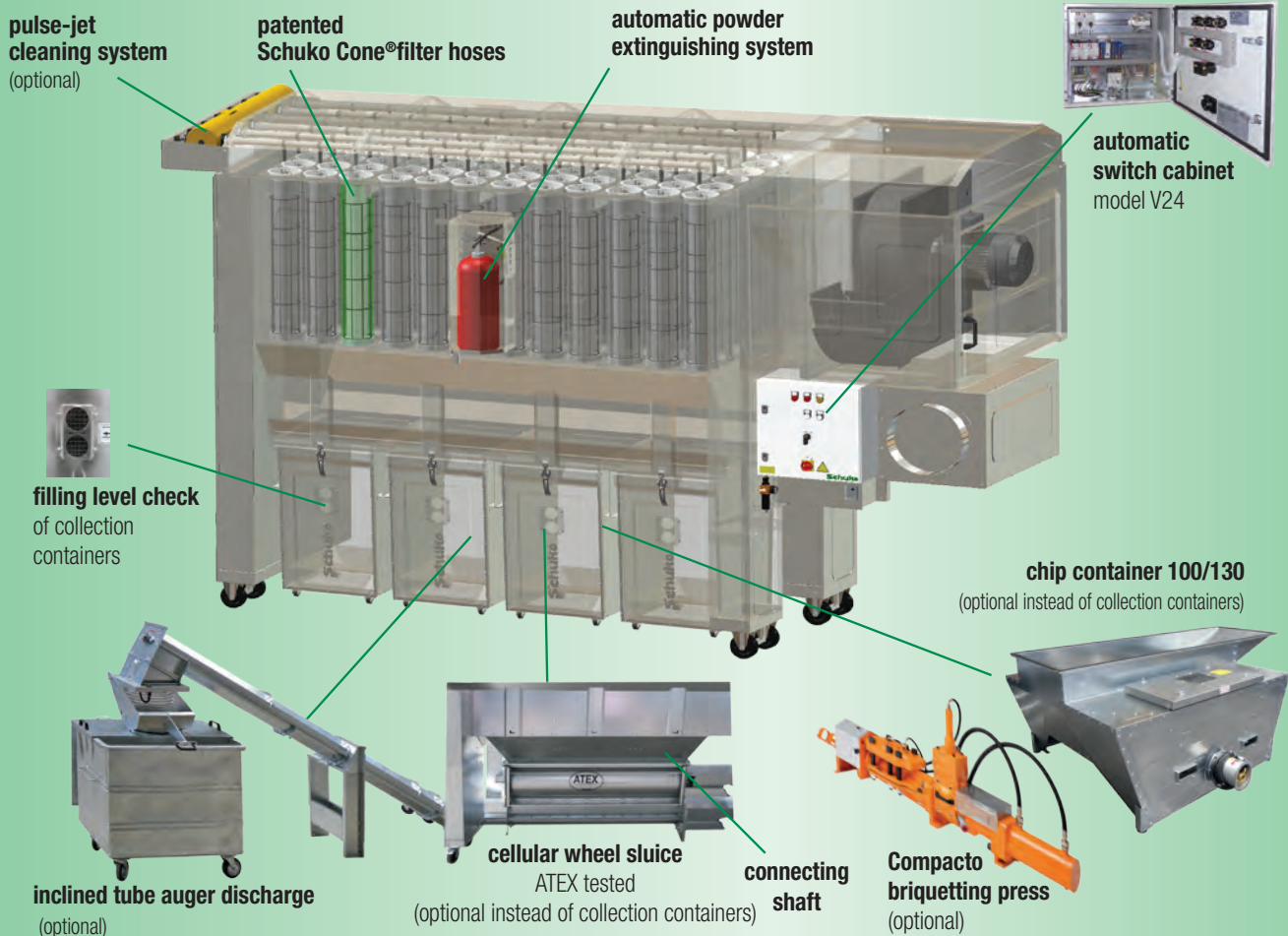

Highlights

Patented Schuko Cone® filter elements:

- filter area of 50 m²
- minimum filter area load
- high degree of separation
- long service life
- compact design

Maximum energy efficiency:

- powerful self-manufactured fans
- energy-efficient German IE3 motors
- minimum resistances due to optimum airflow and short pipe routes
- saving of heating costs due to complete heat recovery in case of indoor installation
- intelligent control in combination with networked machines (optional)

Individual device configuration

- **standard** - 11 kW motor
- inlet side on the right (on the left as an optional extra subject to surcharge)
- **11 kW with frequency converter** for ind. adaptation of extraction performance to amount of air required
- **TWIN** - with 2 x 5.5 kW frequency-controlled motors for maximum individual adaptation of extraction performance under strongly changing operating conditions.

Environmental protection and safety of employees:

- dust value considerably below the prescribed marginal value of 0.1 mg/m³ of ambient air for air return to workrooms
- additional operational safety due to supply air box as expansion room with non-return flap
- safety device: automatic extinguishing device with powder extinguisher in compliance with GS-HO-07 (no water damage)
- low noise level due to double-walled lining of filter hose and fan casing 68/70 dB(A)
- design of device in compliance with new EU standard prEN 16770

Accessories (available as an optional extra)

- **additional switch cabinet control** for activating a maximum of 8 pneum. or motor-operated valves, with/without run time addition
- **pulse-jet cleaning system incl. activating function** for improved filter regeneration (plus 20 kg in weight)
- **cellular wheel sluice** model ZRS 10, 1,400 x 260 mm, ATEX tested
- **shaft** at ZRS 1,400 x 260 mm
- **inclined tube auger** for installation under ZRS 1,400 x 260 mm
- **Compacto briquetting presses**
- **chip container SPB 100/4/130** (capacity 1m³)



We stand for new ideas!

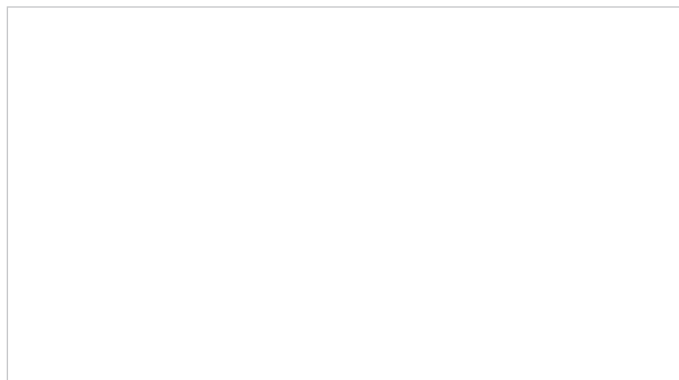

www.schuko.com