



# CASELLI

**Tecnologia al servizio della qualità**  
*Technology at the service of quality*

**Programma produzione**  
*Production program*

**CAMAM**



**Consulenza, progettazione, assistenza: una perfetta integrazione per le sfide del futuro.**  
*Consulting, engineering, technical assistance: a perfect integration for the challenges of the future.*



Veduta parziale dello stabilimento

*Partial view of the plant*



Particolare dell'ufficio vendite

*Detail of the sales office*



Centro elaborazione dati gestione

*Data processing centre*

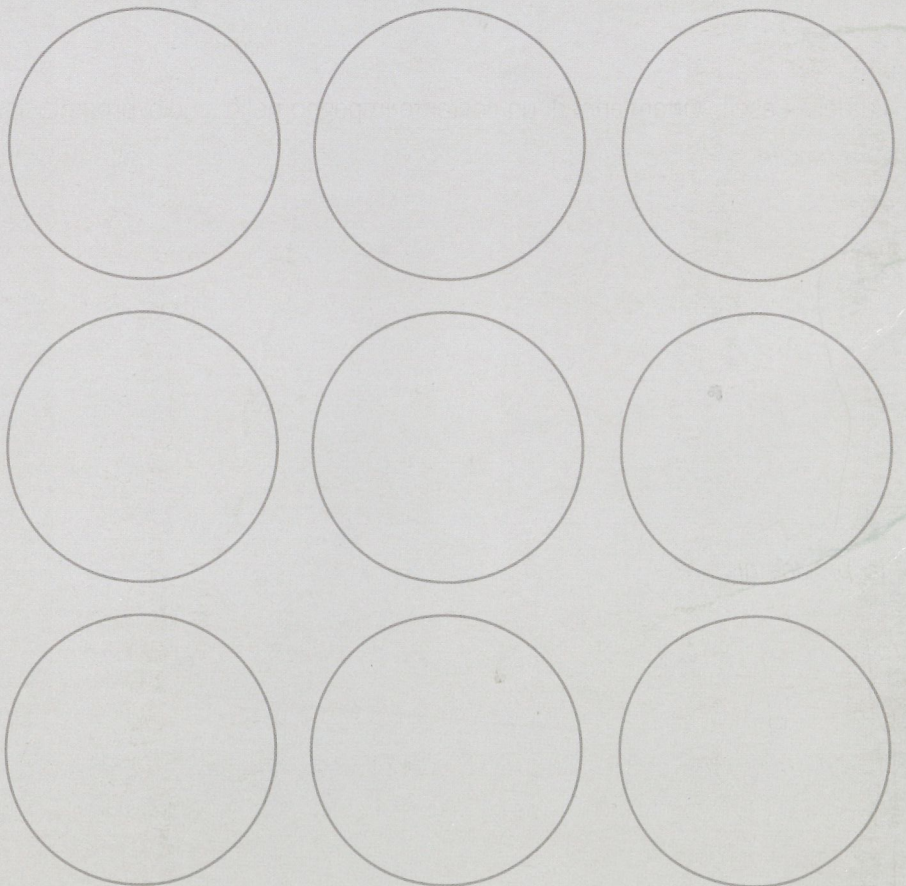





Reparto industriale per  
l'assemblaggio delle macchine

*Machine assembling department*

Magazzini

*Warehouses*

Reparto  
produzione

*Production  
department*



## **Dal 1920, una dinamica azienda al servizio dell'industria del legno.**

Fornire soluzioni globali, di elevata qualità, in grado di risolvere, oggi e domani, ogni esigenza dell'utente: questa è la filosofia della Caselli. Ottant'anni di un costante impegno nello studio, progettazione, costruzione e fornitura di macchine e sistemi completi destinati ai vari comparti dell'industria del legno. L'alta affidabilità nel rispetto di questi principi garantisce al cliente la massima rispondenza alle sue sempre più mutevoli esigenze.

Fornitrice di tecnologie e di innovazione, ma soprattutto valida partner sul fronte della consulenza: un'interlocutrice, la Caselli, in grado di cogliere e ottimizzare, grazie ad un costante aggiornamento nel mercato di settore, ogni nuova opportunità volta al perfezionamento della tecnologia applicata al legno.

*Since 1920, a dynamic company at the service of the woodworking industry.*

*To provide high-quality global solutions, capable of meeting every customer requirement, today and tomorrow: this is the Caselli philosophy. Eighty years of constant application in the study, design, construction and supply of equipment and complete systems for the different branches of the woodworking industry. The high reliability in the respect of these principles assures the customer a constant attention to his ever-changing requirements.*

*A supplier of technologies and innovation, but most of all a valid partner at the consulting level: this is Caselli, a counterpart that, thanks to constant updating in the relative market, recognizes and optimizes every new opportunity tending to improving the technology applied to the woodworking industry.*

# 1] Contornatrici / Router-shapers



## GC1/1F-C

Contornatrice a copiare per sedili e spalliere di sedia ad 1 albero

*Single-shaft copying router-shaper for chair seats and backs*



## GC1/1F GC1/1F/M

Contornatrice a copiare per sedili e spalliere di sedia ad 1 albero

*Single-shaft copying router-shaper for chair seats and backs*

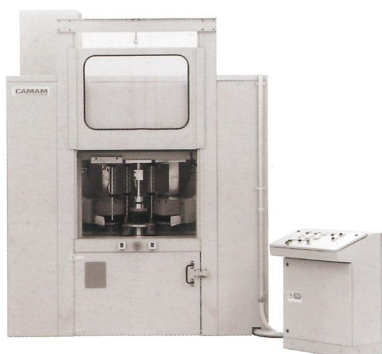

## GC1/2F-C

Contornatrice a copiare per sedili e spalliere di sedia a 2 alberi

*Double-shaft copying router-shaper for chair seats and backs*

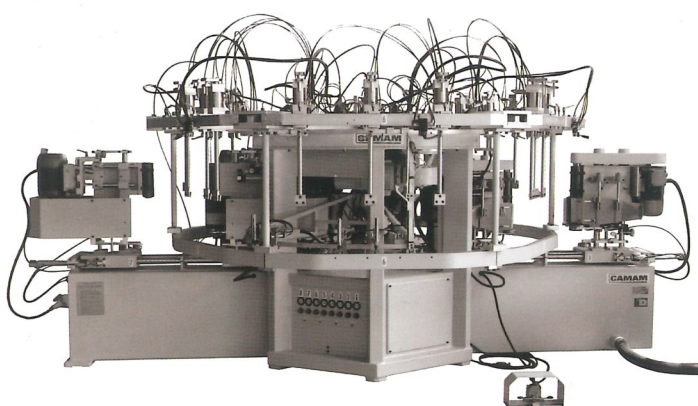
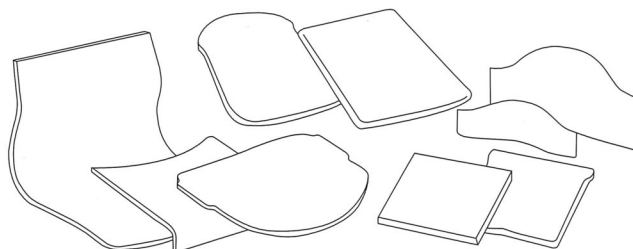

## GC6/4F GC6/4F-2L GC6/6F GC6/4F-4L

Contornatrice a copiare a 6 posizioni di lavoro per la fresatura e levigatura interna ed esterna di gambe di sedia

*Copying router-shaper with 6 working positions for milling and internal and external smoothing of chair legs*

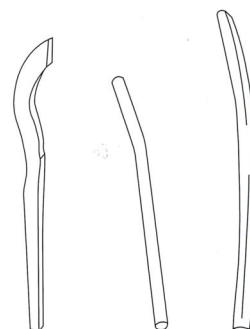



## 2] Mortasatrici / Mortising machines

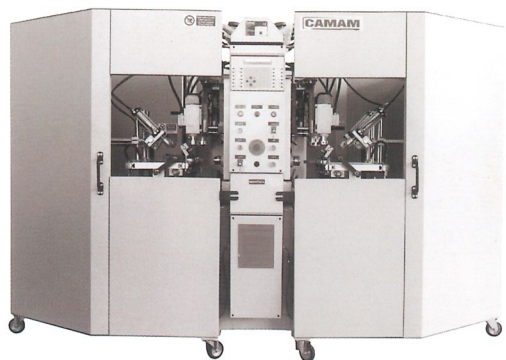

### AF/12/BI/2/PLC

Mortasatrice oscillante multipla automatica verticale/orizzontale con due banchi di lavoro a doppia inclinazione

*Vertical/horizontal automatic multiple oscillating mortiser with two work tables with double inclination*

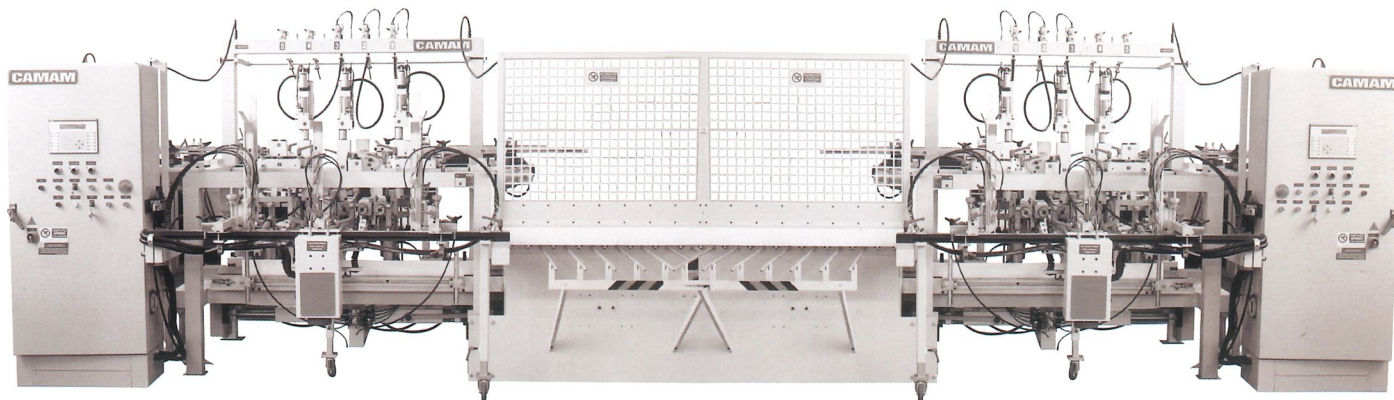
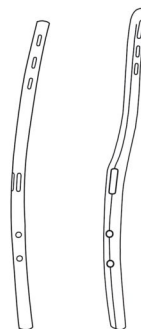

### MF7+7/CR-PLC

Copia di mortasatrici oscillanti multiple verticali/orizzontali a 7+7 unità a mortasare a regolazione universale con caricatore

*Pair of vertical/horizontal multiple oscillating mortisers with 7+7 mortising units with universal adjustment, with loader*

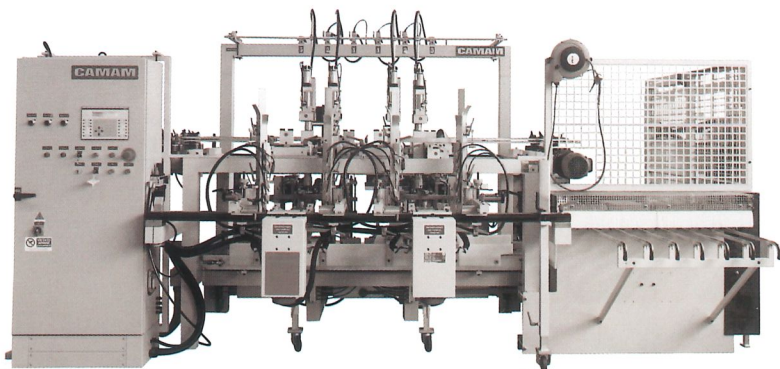
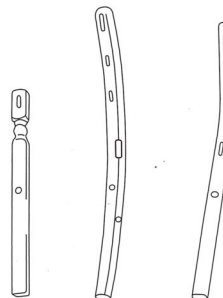

### MF8/CR2/PLC MF10/CR2/PLC

Mortasatrice oscillante multipla verticale-orizzontale a 8 unità e mortasatrice a regolazione universale con due caricatori

*Vertical/horizontal multiple oscillating mortiser with 8 mortising units with universal adjustment, with two loaders*

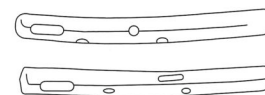
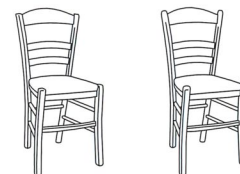



## 2] Mortasatrici / Mortising machines

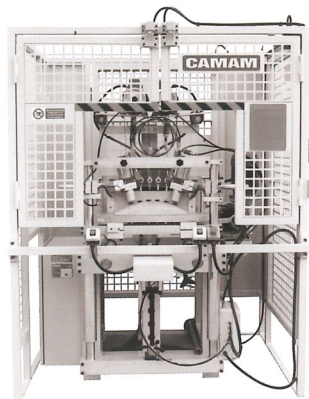

### MOS/...A/2

Mortasatrice oscillante plurimandrino a un banco di lavoro per spalliere curve di sedie

*Multispindle oscillating mortiser with one working table for curved chair backs*

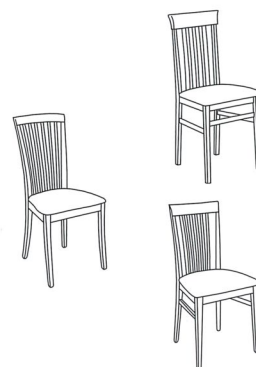
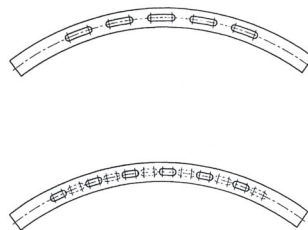

### MO/4A

Mortasatrice oscillante multipla a due banchi di lavoro a quattro mandrini

*Multiple oscillating mortiser with two work tables and four spindles*

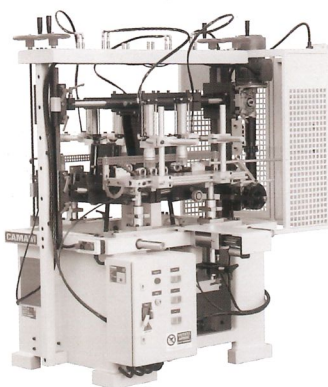
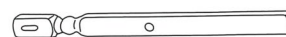

### MO/5A/30X

Mortasatrice oscillante multipla a due banchi di lavoro a tre gruppi oscillanti e cinque mandrini

*Multiple oscillating mortiser with two work tables, with three oscillating units and five spindles*

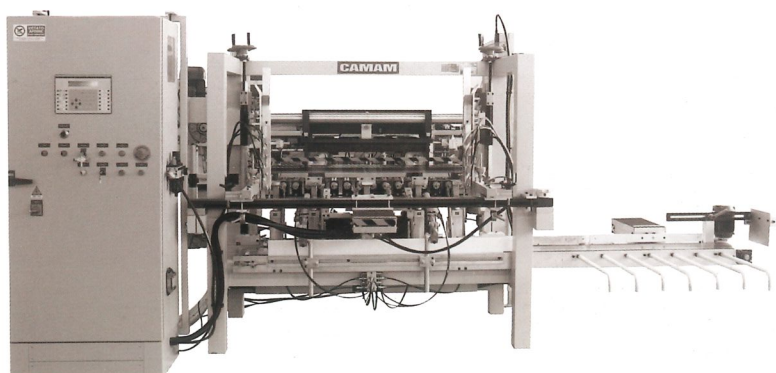

### MO/20/16A/CR-PLC

Mortasatrice oscillante multipla automatica orizzontale a 16 mandrini con caricatore per lettini

*Horizontal automatic multiple oscillating mortiser with 16 spindles with loader for cribs*

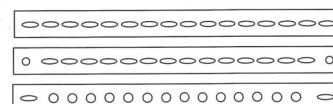



## 2] Mortasatrici / Mortising machines

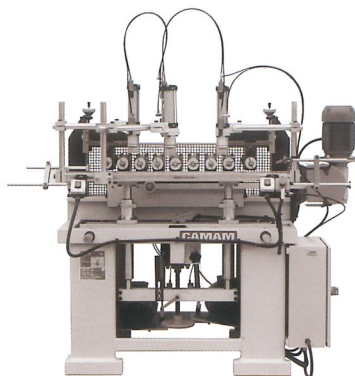

### MO/4A/20X

Mortasatrice oscillante multipla a un banco di lavoro per elementi di lettini

*Multiple oscillating mortiser with one work table for crib elements*

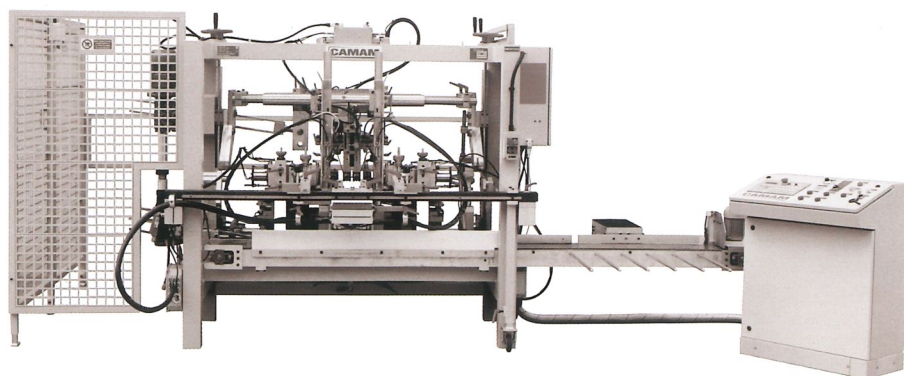
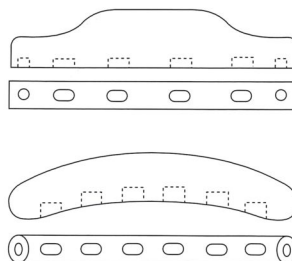

### MO/30/6A/CR-PLC

Mortasatrice oscillante multipla automatica orizzontale con caricatore

*Horizontal automatic multiple oscillating mortiser with loader*

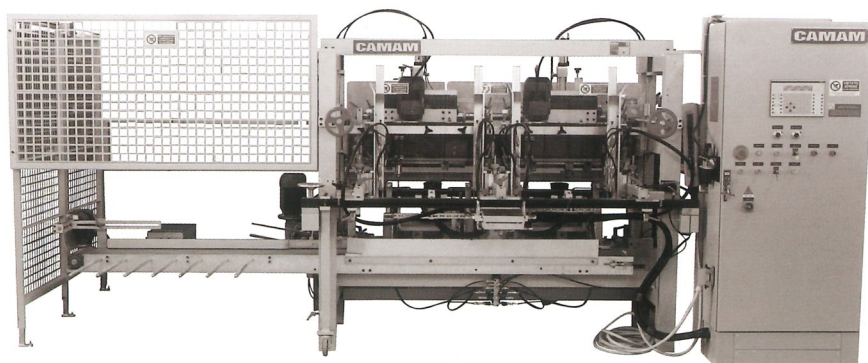
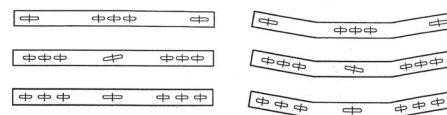
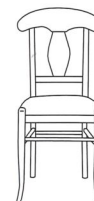

### MO/40/8A/2CR-PLC

Mortasatrice oscillante multipla automatica orizzontale-verticale a 8 mandrini con doppio caricatore

*Horizontal-vertical automatic multiple oscillating mortiser with 8 spindles, with double loader*

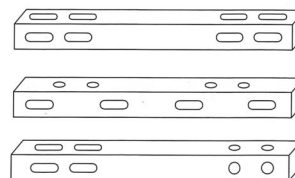



# 3] Foratrici / Boring machines

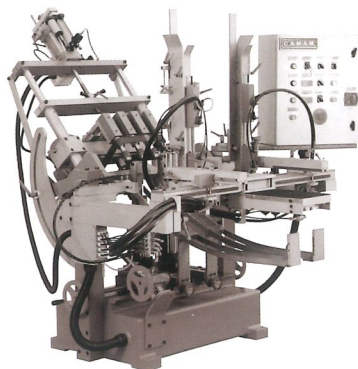

## FMI/CR4

Foratrice multipla inclinabile plurimandrino con caricatore automatico per elementi di sedia

*Multispindle inclinable multiple boring machine with automatic loader for chair elements*

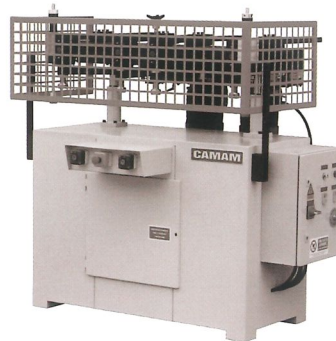
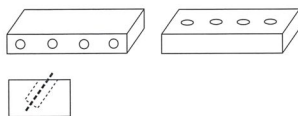

## FM/1000

Foratrice multipla verticale plurimandrino

*Multispindle vertical multiple boring machine*

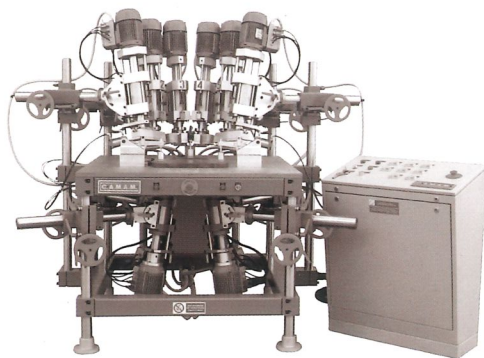
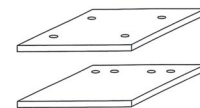

## FMV/4U-6U

Foratrice multipla verticale plurimandrino

*Multispindle vertical multiple boring machine*

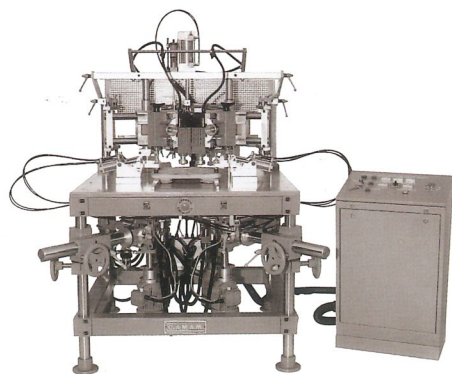
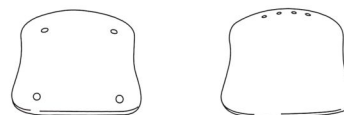

## FM/4U-2MO

Foratrice-mortasatrice automatica per sedili in legno massiccio a 4 unità a forare

*Automatic boring-mortising machine for solid-wood chair seats, with 4 drilling units*

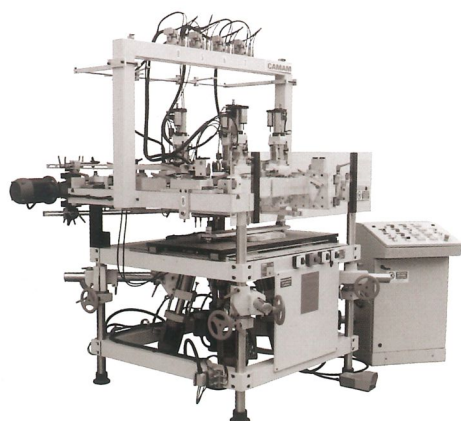
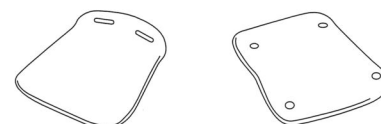

## FM/4U-I/4G-S

Foratrice-mortasatrice multipla per sedili "Old America"

*Multiple boring-mortising machine for "Old America" seats*

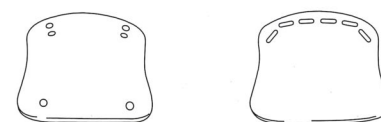



# 4] Fresatrici / Milling machines

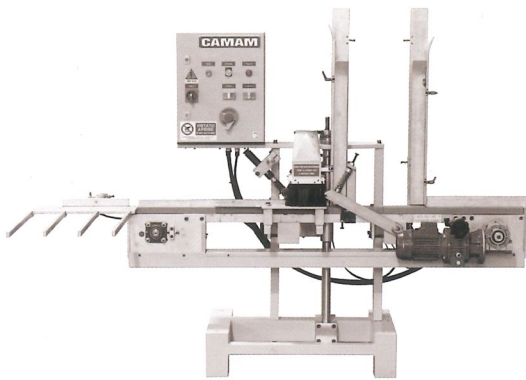

## FCT/CR

Fresatrice longitudinale per tressi

*Longitudinal milling machine for chair crosspieces*

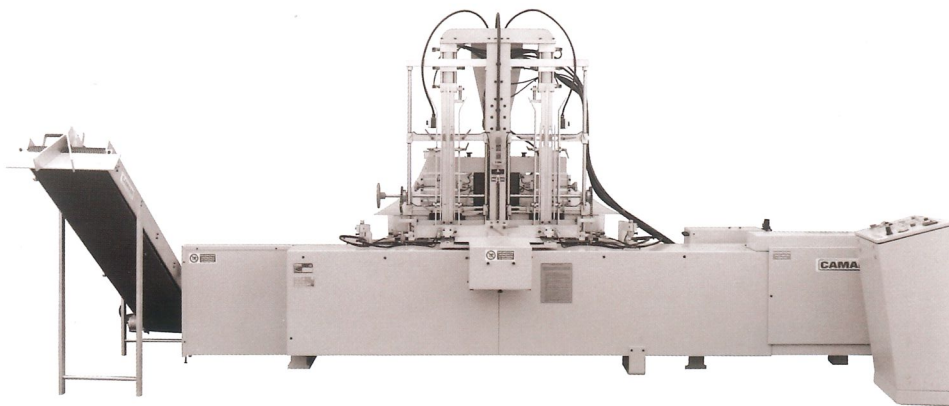
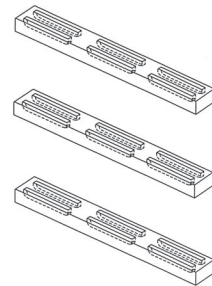

## FDG/P-CR

Fresatrice automatica per angoli di sedia (Gattelli) a due caricatori

*Automatic milling machine for chair corners (corner reinforcements), with two loaders*

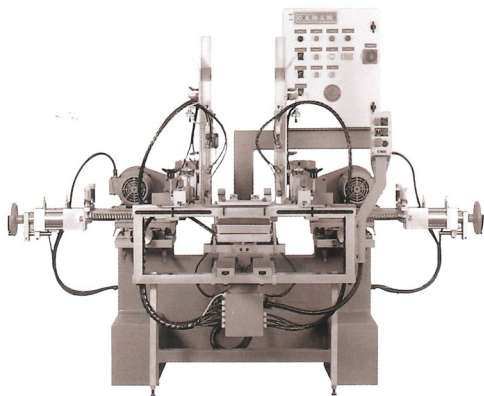
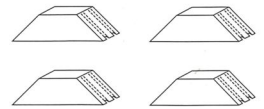

## FDT/AI/PLC

Fresatrice doppia per traversi di sedia a due unità inclinabili con caricatore

*Double milling machine for chair crosspieces with two inclinable units, with loader*

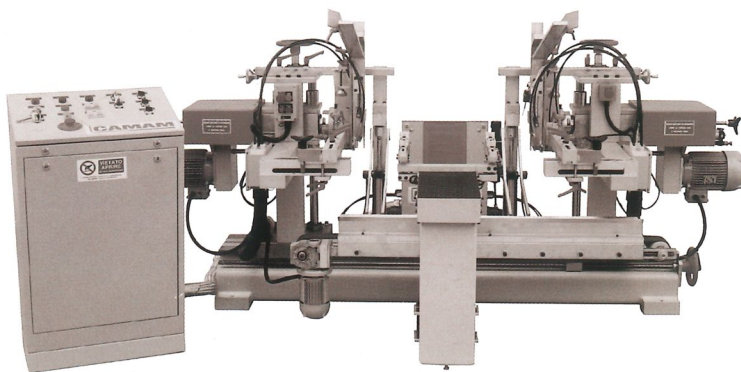
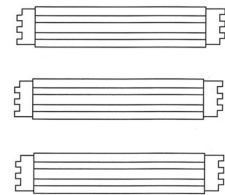

## FDT/CR/PLC

Fresatrice doppia per gambe tonde di sedia con caricatore

*Double milling machine for round chair legs, with loader*

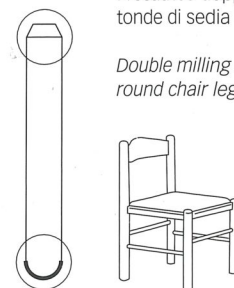



# 4 ] Fresatrici / Milling machines

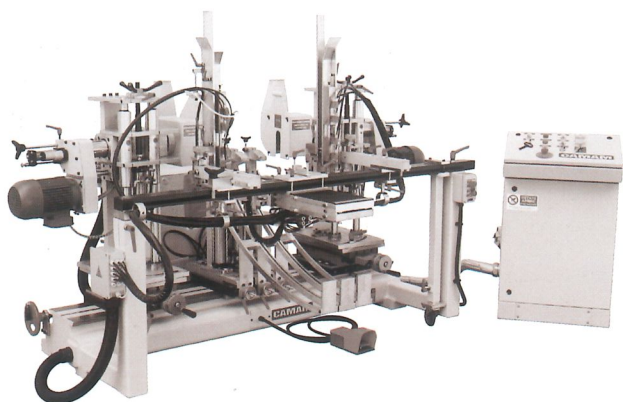

## FDIT/CR-PLC

Fresatrice intestatrice doppia per gambe tonde di sedia con caricatore

*Double end-milling machine for round chair legs, with loader*

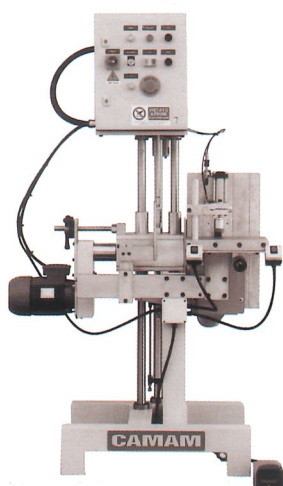
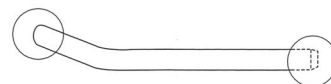

## FS-S/1U

Fresatrice trasversale per elementi di sedia

*Transversal milling machine for chair elements*

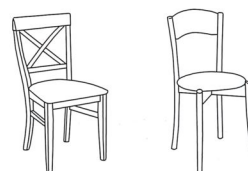
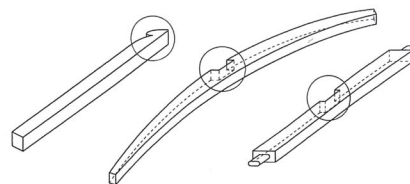

## FV/1T-1P

Fresatrice ad albero verticale

*Vertical-shaft milling machine*

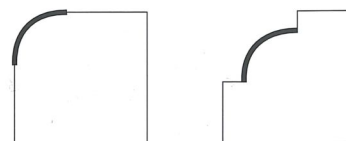



# 5] Levigatrici / Sanding machines

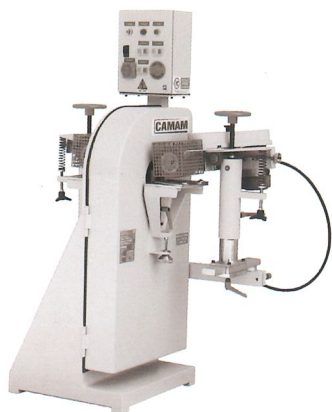

**LEC 50**  
**LEC 100**  
**LEC 150**  
**LEC 200/AV**  
**LEC 200/AVL**  
**LEC 200/AVS**  
**LEC 200AV/W**  
**LEC 250/AV**

Levigatrice orbitale a nastri abrasivi

*Orbital sanding machine with sand belts*

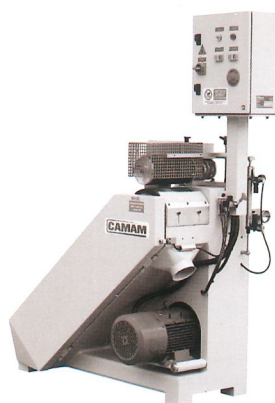
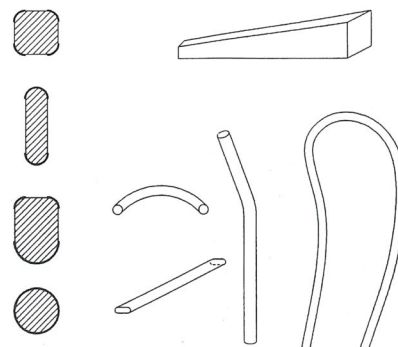

**LOL/75/RU**

Levigatrice a nastro abrasivo per la levigatura longitudinale di gambe e spalliere di sedie

*Sanding machine with sand belt for longitudinal sanding of chair legs and backrests*

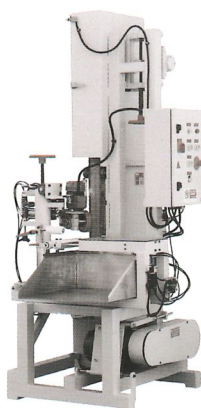
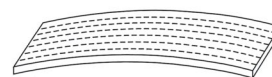

**LV-TC**

Levigatrice verticale a nastro abrasivo per la levigatura delle teste emisferiche di gambe di sedie

*Vertical sanding machine with sand belt for sanding hemispheric heads of chair legs*

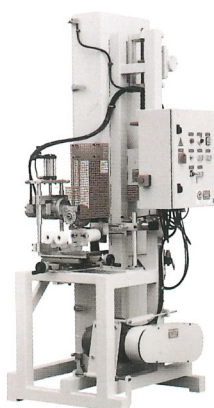
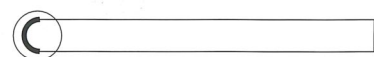

**LV-TT**

Levigatrice verticale a nastro abrasivo per la levigatura delle teste emisferiche di gambe tornite di sedie

*Vertical sanding machine with sand belt for sanding hemispheric heads of turned chair legs*





# 5] Levigatrici / Sanding machines

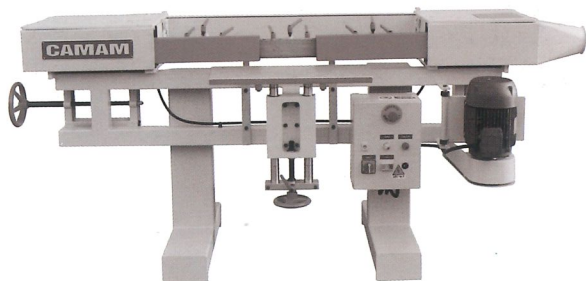

## LOV/3V/55

Levigatrice orizzontale a nastro abrasivo verticale.

*Horizontal sanding machine with vertical sand belt*

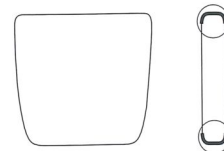
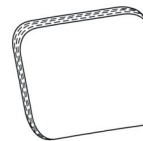

## LO/1V/100/T LO/3V/75 LO/3V/75/T

Levigatrice orizzontale a nastro abrasivo con o senza gruppo di avanzamento

*Horizontal sanding machine with or without sand belt, without feed unit*

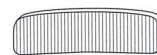

## LV/3V/55 LV/3V/75/T

Levigatrice verticale a nastro abrasivo con o senza gruppo di avanzamento

*Vertical sanding machine with sand belt with or without feed unit*

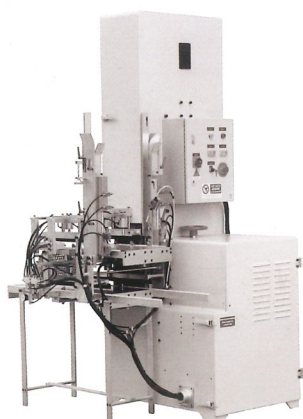
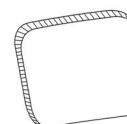

## LV/LST/CR

Levigatrice verticale a nastri abrasivi con caricatore per levigare e spigolare teste di gambe quadre di sedia

*Vertical sanding machine with sand belts with loader for sanding and shaping edges on heads*





# 5 | Levigatrici / Sanding machines

**Spazzolone**  
Buffing brush

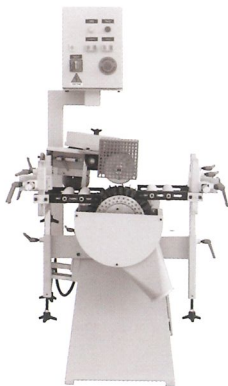

**CAM/T**

Spazzolone con  
asse bisporgente  
con avanzamento

*Buffing brush with  
double-projecting  
shaft, with feed  
unit*

**Spazzolone**  
Buffing brush

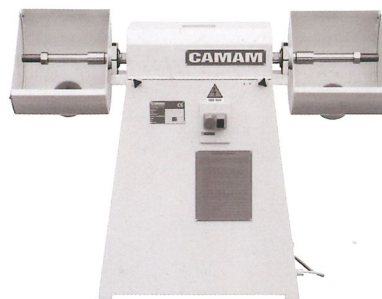

**CAM**

Spazzolone con asse  
bisporgente

*Buffing brush with  
double-projecting  
shaft*

**Spazzolatrice**  
Brushing machine



**SAW 91**

Spazzolatrice rotante per la  
spazzolatura di teste sagomate  
di gambe di sedia

*Rotary brushing machine  
for brushing shaped heads  
of chair legs*

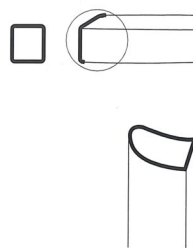

## Linee di levigatura:

Gambe Tonde di sedia.

Tressi di sedia

*Sanding lines:*

*Round chair legs; chair  
crosspieces*

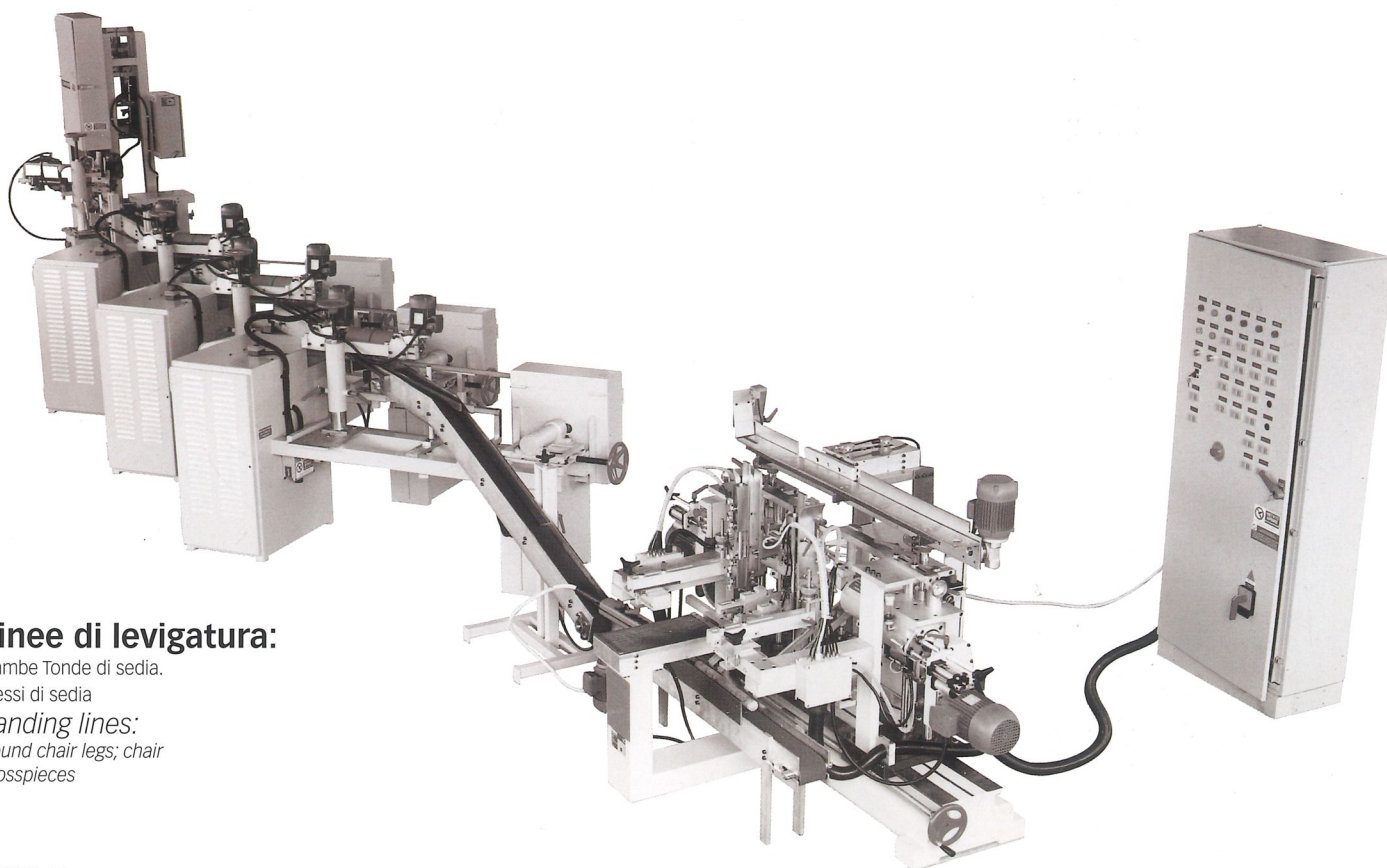

# 6 ] strettoi / Clamps

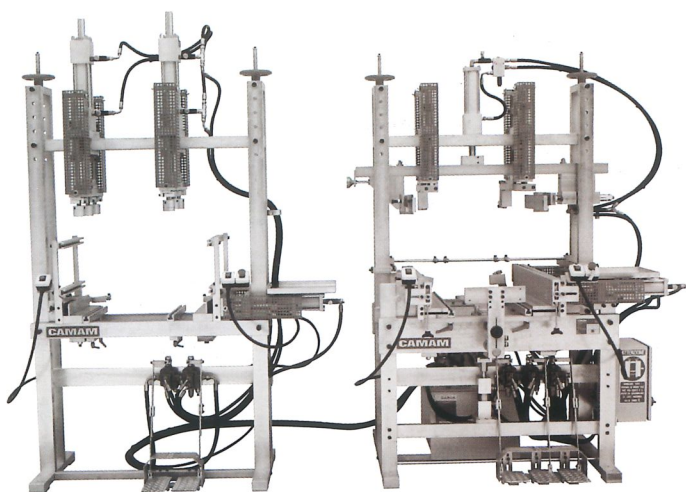

## SI/PM SI/PM-T-TS

Coppia strettoi idraulici  
per il montaggio di sedie

*Pair of hydraulic clamps  
for assembling chairs*

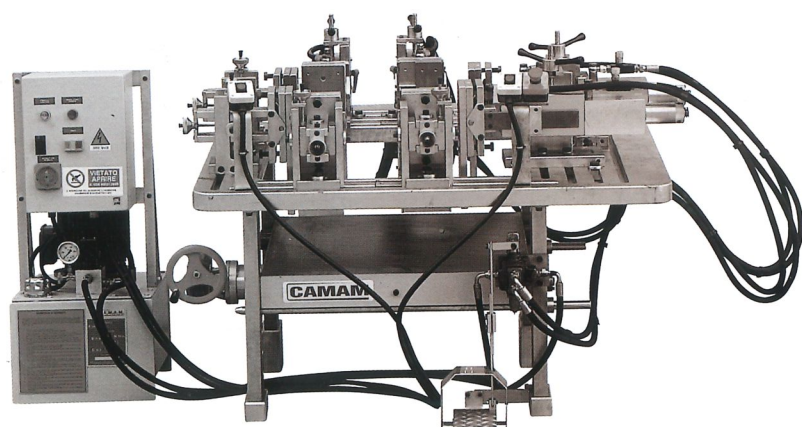
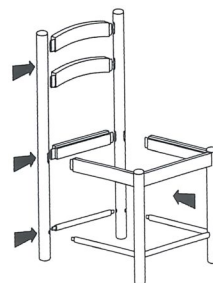

## SI/F/4C SI/F/5C

Strettoio idraulico a fossa  
per il montaggio di sedie

*Pit hydraulic clamp  
for assembling chairs*

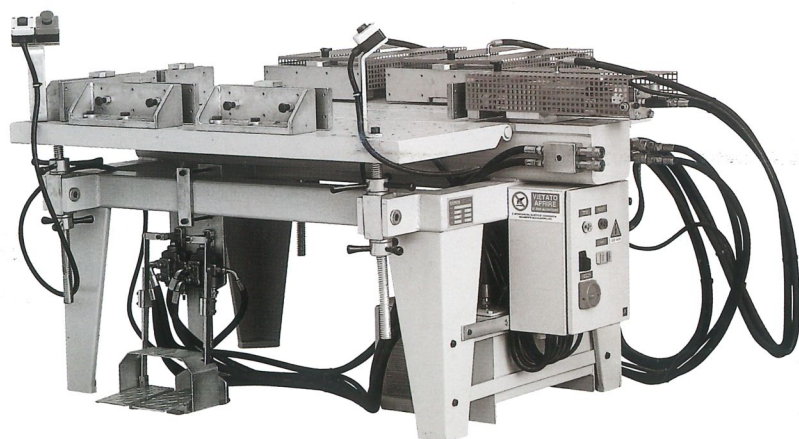
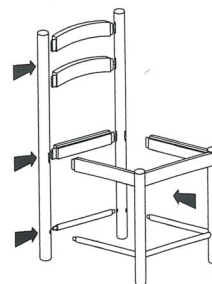

## SI/3L/GI

Strettoio idraulico a due banchi  
registrabili a libro per il montaggio  
di schienali di sedia

*Hydraulic clamp with two folding  
adjustable tables for assembling  
chair backs*

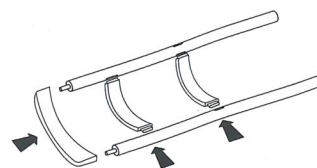



# 6] Strettoi / Clamps

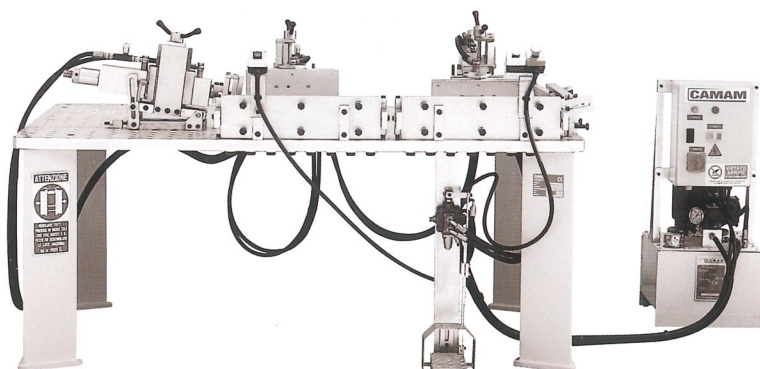

## SI/B/3C

Strettoio idraulico a banco  
fisso per il montaggio  
di schienali

*Fixed-table hydraulic clamp  
for assembling chair backs*

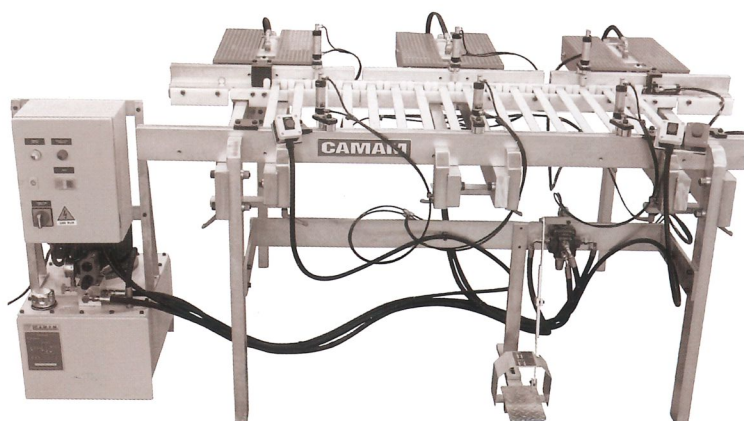
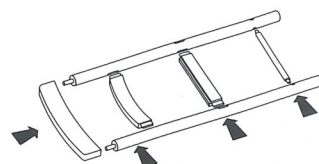

## SI/L/3C

Strettoio idraulico  
a banco per il montaggio  
di spondine di lettini  
d'infanzia

*Table hydraulic clamp for  
assembling crib sides*

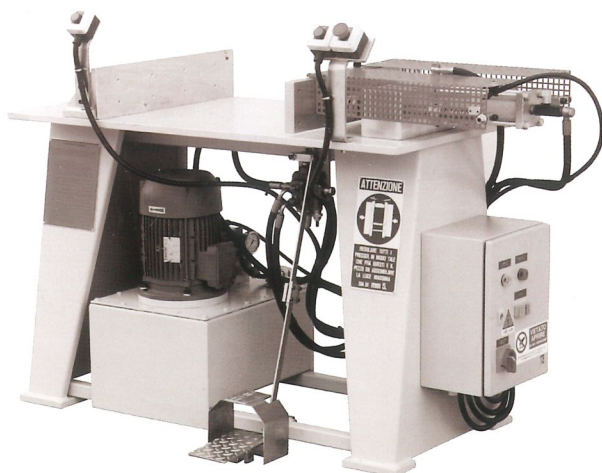
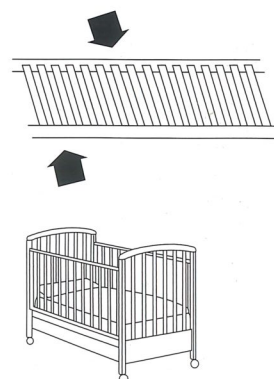

## SI/1C

Strettoio idraulico  
a banco fisso

*Hydraulic clamp  
with fixed table*

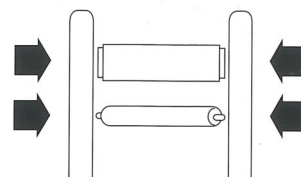

**Troncatrice**  
Cropping saw

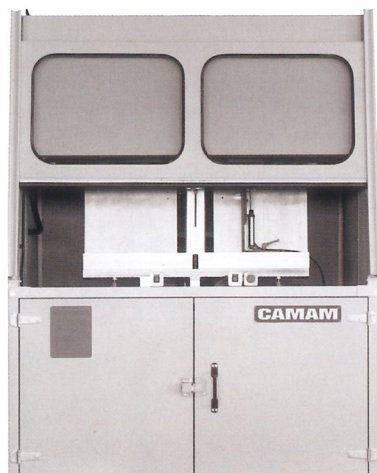

**TG**

Troncatrice per angoli di sedie (Gattelli)

*Cropping saw for chair corners (corner reinforcements)*

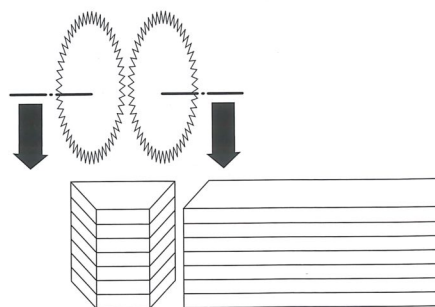

**Intestatrice**  
End-milling machine

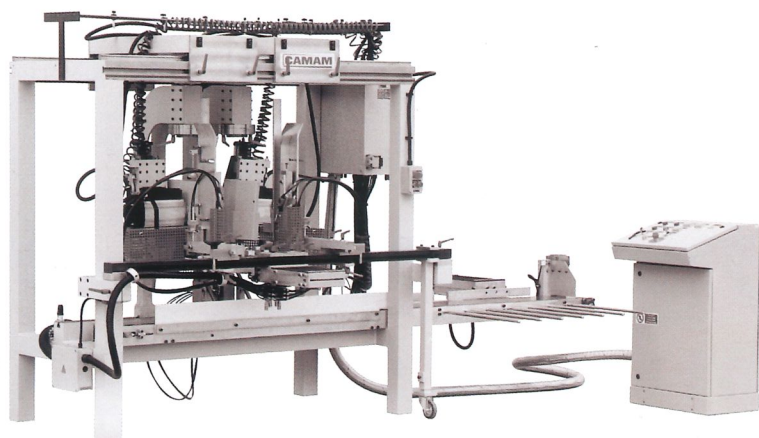

**ID 1200 CR-PLC**

Intestatrice doppia per elementi di sedie con caricatore

*Double end-milling machine for chair elements, with loader*

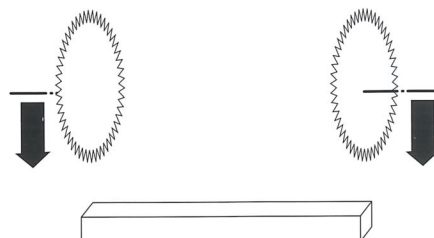

**Zigrinatrici**  
Knurling machines



**ZS**

Zigrinatrice semplice per pezzi piatti e tondi di sedie

*Single knurling machine for flat and round chair elements*

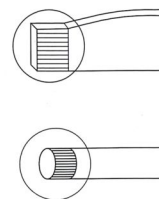



Zigrinatrici  
Knurling machines

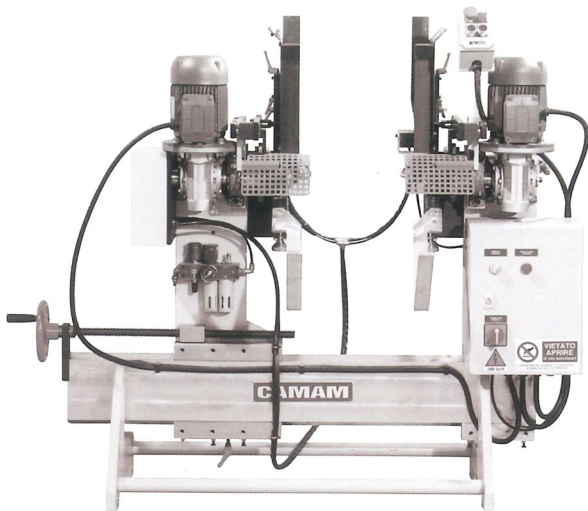

ZD/1

Zigrinatrice doppia  
per fuselli di sedie

Double knurling machine  
for chair spindles

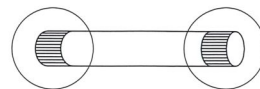

Zigrinatrici  
Knurling machines

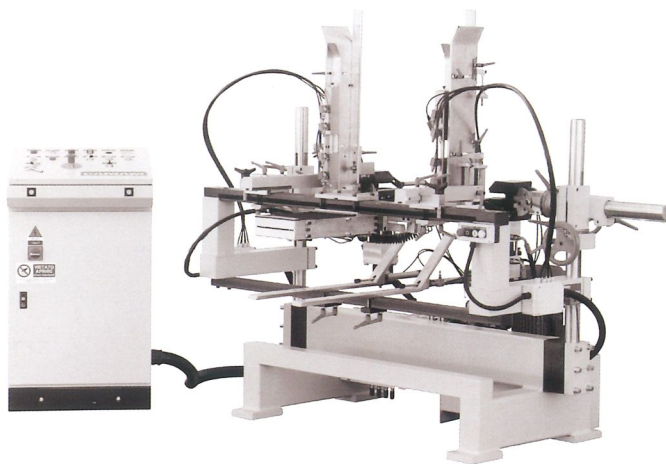

ZDI/2P

Zigrinatrice doppia  
idraulica per traversi  
di sedia con caricatore

Hydraulic double knurling  
machine for chair  
crosspieces, with loader

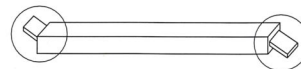

Tenditrice  
Belt tensioner

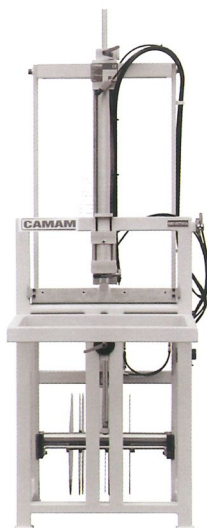

TP/1/2P

Tenditrice di cinghie  
elastiche per tappezzeria

Tensioner of elastic belts  
for upholstery

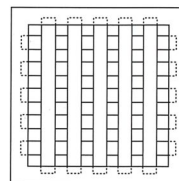

**Avvitaborchie**  
*Upholsterer's nail driver*



**AVB**

Avvitatrice di viti,  
prigionieri e bussole

*Driver for screws,  
studs and bushes*



**Uguagliatrice**  
*Levelling machine*



**US/1C**

Uguagliatrice a lama  
circolare per piedi di sedia

*Disk blade levelling  
machine for chair feet*

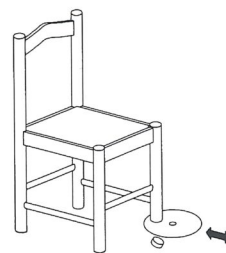

**Spigolatrice**  
*Edger*



**SMT/V**

Spigolatrice per gambe  
di sedie

*Edger for chair legs*

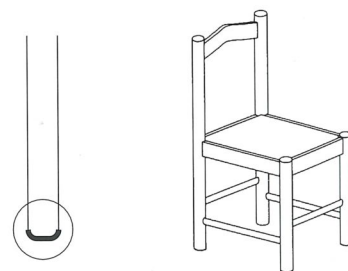





# CASELLI

VERSO LA PERFEZIONE

**Organizzazione commerciale  
e distribuzione generale**

via Nazionale 87  
33048 San Giovanni al Natisone  
Udine Italy  
tel. 0432 757064  
fax 0432 757618  
<http://www.casellispa.com>  
e-mail: [info@casellispa.com](mailto:info@casellispa.com)