



olimpic k 560

automatic edge bander



olimpic k 560



automatic **edge bander**

Versatile and with high performance, Olympic k 560 has been designed for all companies that require continuous and high quality production of a large number of panels even though they are all different from one to the next. Olympic k 560 is now enriched with many solutions that guarantee always **the best machining on any panel type**.



OLIMPIC		K 560
Panel thickness	mm	8 - 60
Edge thickness	mm	0,4 - 3 (opt. 8)
Feed speed	m/min	12 / 18
Compressed air	bar	6

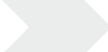

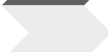
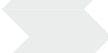
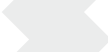
-  cutting
-  **edge banding**
-  boring-routing
-  calibrating-sanding
-  assembling

olimpic k 560

technological **advantages**



toptech

“SGP” GLUE POT (SMART GLUE POT): PERFECT JOINT LINE AND USE OF EVA AND POLYURETHANE GLUE

Ideal glue line obtained through the spreading roller with a special knurling with variable pitch, and perfect dosing on any panel type. The use of EVA and Polyurethane glue is made possible by the anti-adherent plasma treatment and a fast and simple glue changeover.

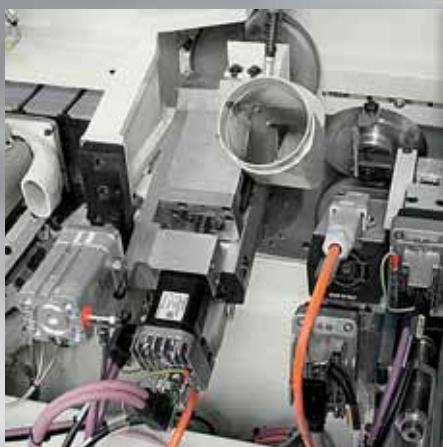

“MULTIEDGE” OPERATING UNITS: THE BEST SET UP FOR ANY PANEL

Rapid and precise machining changeover between 2 different radii, thin edges and solid wood through controlled axes, for the best machining quality with any panel type.



AIRFUSION: “ZERO” GLUE LINE

Extraordinary finishing quality with the AirFusion technology that allows edgeworking without glue, thus ensuring that the joint between the edge and the panel is invisible.

AirFusion
by scm group

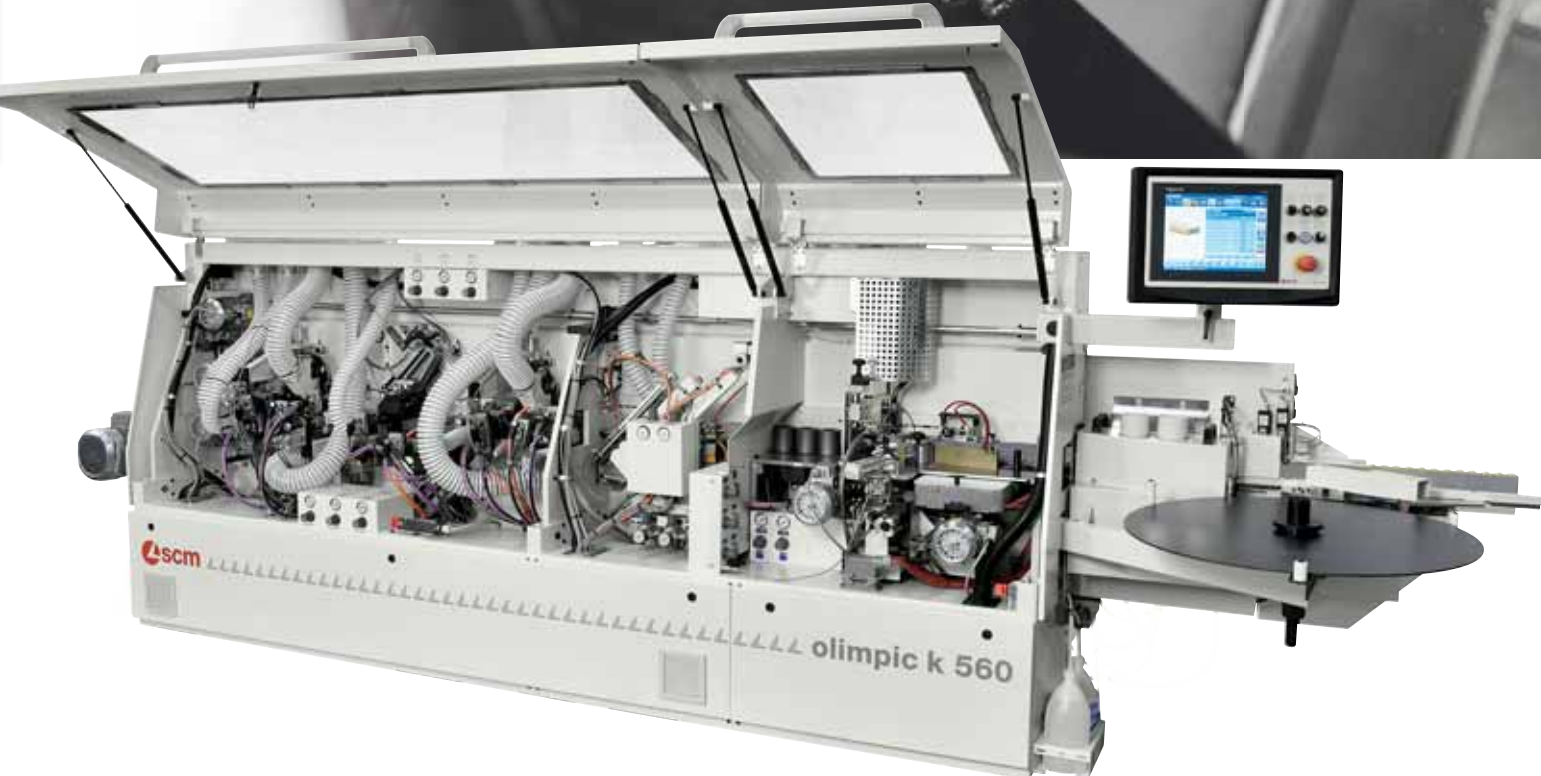

olimpic k 560

operating groups



STARTOUCH CONTROL: JUST A "TOUCH" TO USE THE MACHINE

- Intuitive and easy to use thanks to its customized graphics and one touch mode
- Large dimensioned display (12") (opt.)
- Simple when choosing the machining required
- "TELESOLVE" (opt.) for diagnostics and on line service



BAR CODE READER

No errors with the automatic program recall (opt.).



RT-V PANEL EDGE TRIMMING UNIT: A PERFECT EDGE JOINT LINE

Surface without any imperfection on the panel edge before gluing. Utilizes 2 motors with opposite rotation and with **large diameter diamond tools (100 mm)**. Panel edge trimming up to 3 mm thickness.

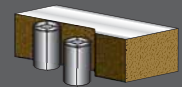

AAR ANTI-ADHESIVE GROUP

The **highest level of panel cleaning** by using spray guns that prevent any sticking of excess glue on the upper and lower panel surfaces (opt.).

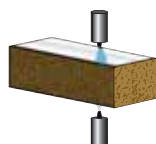

INFRARED CERAMIC LAMP

Optimum glue adhesion with the heating of the surface to be machined (opt.).

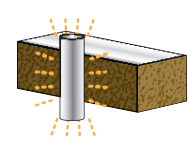



VC 800 gluing unit

**GLUING UNIT:
ALL YOU NEED FOR QUALITY
EDGE-BANDING**

A complete range of advanced technological solutions guarantees the perfect edge application in any working condition.

AIRFUSION DEVICE:

A “zero” glue line is obtained with the AirFusion technology that allows edgebanding without glue, thus ensuring that the joint between the edge and the panel is invisible (opt.).

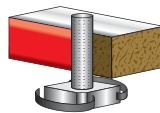

SGP glue pot

SGP GLUE POT “SMART GLUE POT”:

Ideal glue line obtained through the spreading roller with a special knurling with variable pitch, and a perfect dosing on any panel type. The use of EVA and Polyurethane glue is made possible by the anti-adherent plasma treatment and a fast and simple glue changeover (opt.).

PRE-MELTING UNIT:

The best glue quality available at any time, with the pre-melting unit for EVA glue ensuring that “freshly” melted glue is always on hand inside the glue pot (opt.).

AirFusion
by scm group



**K/SEL END CUTTING UNIT: ALWAYS
THE BEST CUTTING QUALITY**

The best finishing quality in every edge banding operation using motors sliding on prismatic guideways and with the automatic tilting of the blades (opt.).



olimpic k 560

operating groups

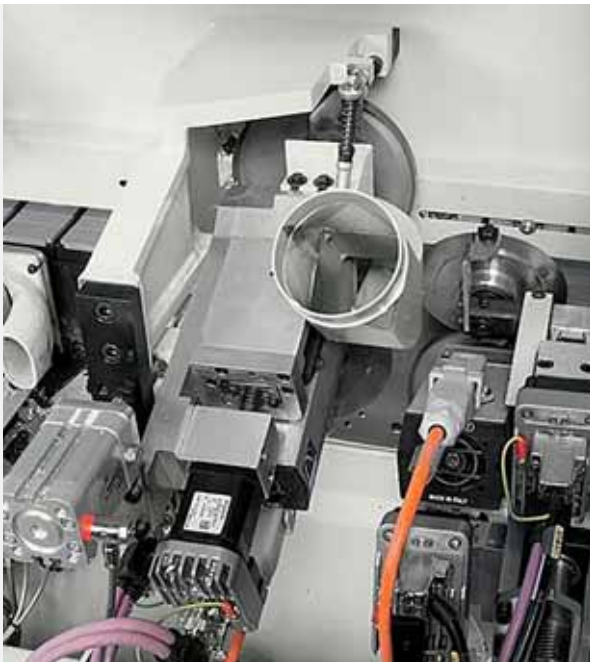

R-HP trimming unit

TRIMMING UNIT: QUICK MACHINE CHANGEOVER

Possibility to trim 2 different radius edges (R-HP), thin edges and solid wood lippings with automatic unit adjustment through 4 NC-controlled axes or with pneumatic positioning.

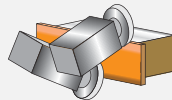

R-K trimming unit

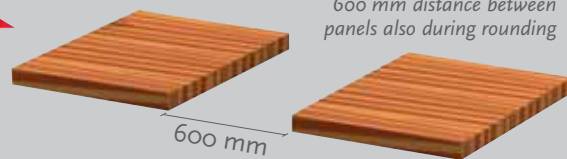
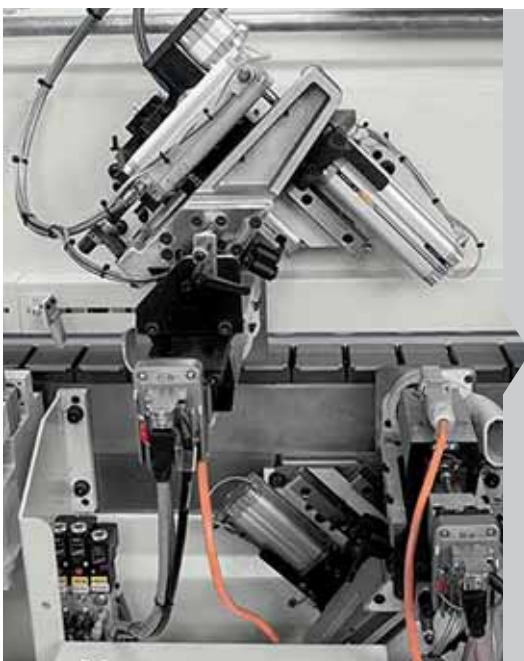
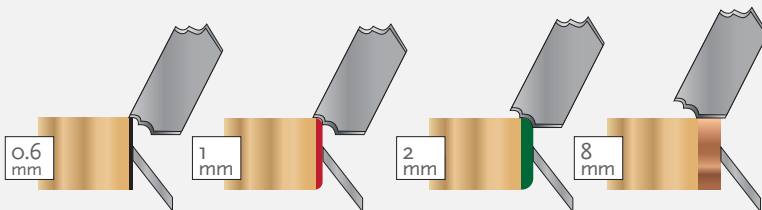

600 mm distance between panels also during rounding

600 mm

ROUND X ROUNDING UNIT: PRODUCTIVITY AND QUALITY WITH 2 MOTORS TECHNOLOGY

The features of the unit allow the double function of both the simultaneous trimming and rounding operations. The two joint operations, in a single group, require less space and, together with the working distance between panels of only 600 mm, give a reduction in time for the edge banding of panels.

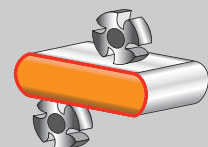



RAS/K edge scraping unit

**EDGE SCRAPING UNIT:
FOR A PERFECT RADIUS OF PLASTIC EDGES**
High finishing quality of the PVC/ABS edges, thanks to the complete elimination of the marks left from the tools during trimming operations. Possibility to trim 2 different radii with the NC automatic set up of 4 axes (RAS-HP).

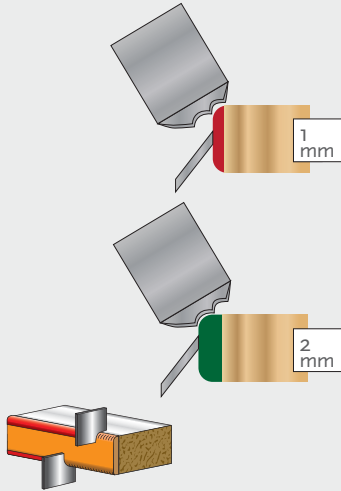

RAS-HP edge scraping unit

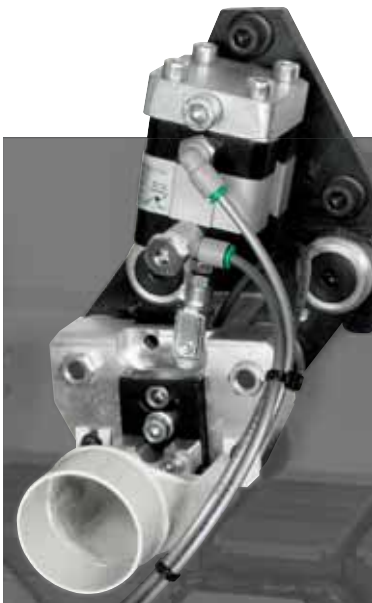

**RC-V GLUE SCRAPING UNIT:
A PERFECT EDGE JOINT LINE**

It eliminates any excess of glue on the panel/edge joint. It allows the removal of any excessive plastic edges (0,1 mm for edges up to 1 mm) (opt.).
- Extraction hood with a suitable container and filter for long chips

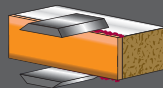

**BRUSHING
UNIT**

Cleaning and polishing of the panel edge (opt.).

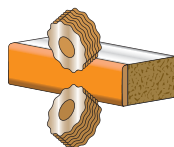

**NESTING
COPYING
DEVICES**

The best finishing of panels with holes for hinges on the upper side due to the copying devices with 3 rotating contact points (available for R-HP and RAS-HP).



olimpic k 560

technical data and configurations

OLIMPIC K 560

dimensions

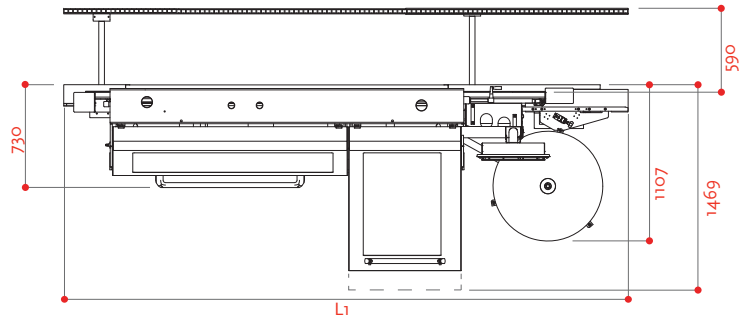



























Composition	E HP E	T-E HP T-E	ER2 HP ER2	T-ER2 HP T-ER2
Length - L1 (mm)	3987	4167	4587	4767

Maximum noise levels measured according to the operating conditions established by EN ISO 18217:2015. Acoustic pressure in process 80 dBA (measured according to EN ISO 11202, uncertainty K = 4 dB). Acoustic power in process 96 dBA (measured according to EN ISO 3746, uncertainty K = 4 dB). Even if there is a correlation between above mentioned "conventional" noise emission values and average levels of personal exposure over eight hours of operators, these last also depend on the real operating conditions, duration of exposure, acoustic conditions of the working environment and presence of further noise sources, this means the number of machines and other adjacent processes.

OLIMPIC K 560

available solutions

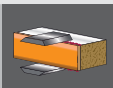
E HP E		1S	1/2							
T-E HP T-E		1S	1/2							
ER2 HP ER2	1S	1/2								
T-ER2 HP T-ER2	1S	1/2								
OPTIONAL GROUPS	1S	→		1/2	→					



LOWER CONSUMPTION = LOWER COSTS = MORE COMPETITIVENESS

SavEnergy allows the use of power only when it is required, making things operate only when they are really necessary. It means the machine automatically enters "stand-by" mode when there are no panels to be machined at any particular time (opt.).

 **scm**
 **routech**
 **celaschi**
 **dmc**
 **superfici**
 **sergiani**
 **gabbiani**
 **morbidelli**
 **mahros**
 **stefani**
 **cpc**
 **scmgroup**
engineering
 **scm**
 **minimax**

1 large integrated group
3 main production sites in Italy and other plants worldwide
20 foreign branches
More than 65 years in business
80% export
350 agents and distributors
More than 400 registered patents
500 engineers
3.000 square meters of showroom in Rimini
17.000 machines manufactured per year
600.000 square meters of headquarters and plants worldwide

scm  **group**

www.scmgroup.com



[www.scmgroup.com/qrcode/v1/](http://www.scmgroup.com/qrcode/v1)



www.scmgroup.com/it/mission_scm

The technical data can vary according to the requested machine composition. In this catalogue, machines are shown with options. The company reserves the right to modify technical specifications without prior notice; the modifications do not influence the safety foreseen by the CE Norms.





SCM GROUP SPA SCM - via Casale 450 - 47826 Villa Verucchio, Rimini - Italy
tel. +39 0541 674111 - fax +39 0541 674274 - scm@scmgroup.com - www.scmgroup.com



0000559198F