

Edge banding machine KAL 210/5/A3/S2



Making more of your edges



KAL 210/5/A3/S2: The new standard in edge banding

Does the sound of low investment plus high profit appeal to you? Nothing could be easier. It is to fulfil just this remit that we have launched the new KAL 210/5/A3/S2. By pursuing a consistent strategy of standardization and efficient series production, we are able to offer this machine with an unimaginably low price tag. Without compromising the superb standard of quality and impressive performance you have every right to expect from a HOMAG machine. There has never been a better time to step into the world of edge banding. Thanks to the KAL 210/5/A3/S2 from HOMAG – impressive performance at an impressively low price.



Practically oriented equipment

A uniform, practically based standard equipment was created for all the machines of the series. The performance and functional scope of the KAL 210/5/A3/S2 have been precisely tailored to match the needs of small-scale industrial producers. The outcome: A machine which even in its basic version addresses more than 95% of all conceivable applications. And the KAL 210/5/A3/S2 is also designed with the capacity for simple automation if required.

Top quality technology all-in

In terms of its technical equipment, no corners have been cut in the design of the KAL 210/5/A3/S2 series. Quite the opposite. These machines have benefited from the inclusion of know-how which has stood the test of time in our high-performance machine ranges. Which means that the KAL 210/5/A3/S2 can be used efficiently to process practically any type of edge material – making you more efficient and flexible. And you will benefit from same high standard of HOMAG quality and reliability that you would expect to find in any of our machines: Our quality standards apply equally right across all our machine ranges.



One series for many types of material

The new KAL 210/5/A3/S2 is capable of processing a wide ranging selection of different coil edging materials such as: melamine, PVC, ABS and veneer edges to name just a few. Hot melt glue is used for banding.

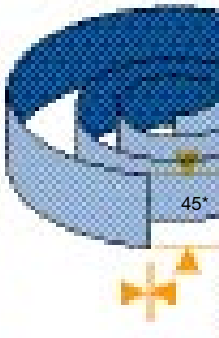
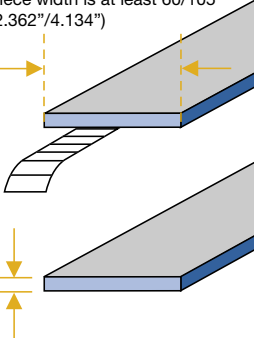
Machine type	Edging material	Workpiece size
<p>KAL 210/5/A3/S2</p>	<p>Coils</p>	<p>With a workpiece thickness of 22/40 (0.866"/1.575"), the workpiece width is at least 60/105 (2.362"/4.134")</p>
	 <p>0.3-3.0 (0.012"-0.118")</p>	 <p>min./max. 12/40 (0.472"/1.575")**</p>

Dimensions in mm

* optionally 65 (2.559")

** optionally 60 (2.362")

KAL 210/5/A3/S2 – everything comes as standard

The KAL 210/5/A3/S2 offers an impressive range of efficient equipment features which were previously reserved to far higher-priced machines. A highly economical complete solution which covers practically every conceivable requirement when it comes to coil material without decimating your budget.

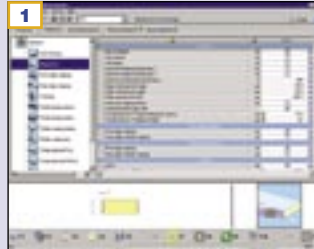

1 power control system PC22
Extremely user friendly due to menu prompting in Windows XP standard for ergonomic machine operation.



2 USB port
For data input or data backup to an external memory. This allows the complete data set to be downloaded from the machine's control system and safely stored. The 1:1 data backup facility ensures that the system is immediately back up and running after an interruption.



7
Gluing technology without servo edge feed

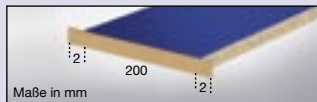

Optimized gluing technology with servo edge feed

Servo edge feed

For precisely positioned edge banding on the workpiece leading and trailing edge (+/- 2mm). This means less waste, and lower consumption of edging material. Possible savings can add up to 20,000 running metres of edging every year.

* If processing appr. 100,000 to 150,000 workpieces on four sides

8 Glue roller lift-off

In case of a feed stop. This eliminates the scrap which can be produced by even a minor feed stop, and allows every individual part to be used – which can make a positive impact on production economy.



9 Magazine with dual rollers
Permits fast, trouble-free edging material changeover as well as manual feed into the machine.

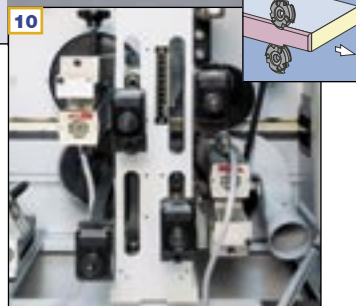

10 Trimming unit 0.4 kW
For trimming edges at the top and bottom workpiece faces with a 15° chamfer or radius – meaning that only a single unit is required for chamfer and radius processing.

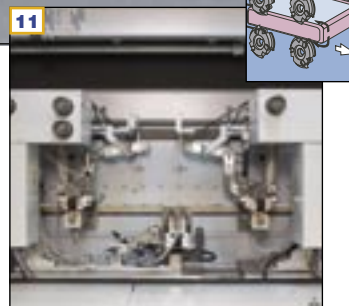

11 Profile trimming unit FF 12
For rounding leading and trailing workpiece edges with a 15° chamfer or radius. One unit for both processing steps.

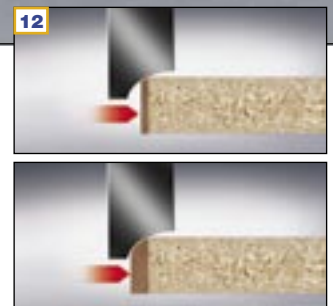

12 Chamfer/radius adjustment
Manual adjustment of the trimming units for simple changeover from chamfer to radius or vice versa.



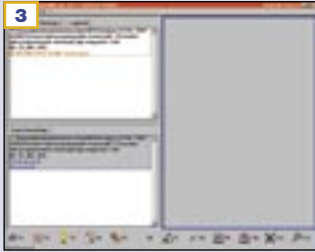

Diagnostic system

With plain text error messages for systematic troubleshooting and enhanced machine availability.

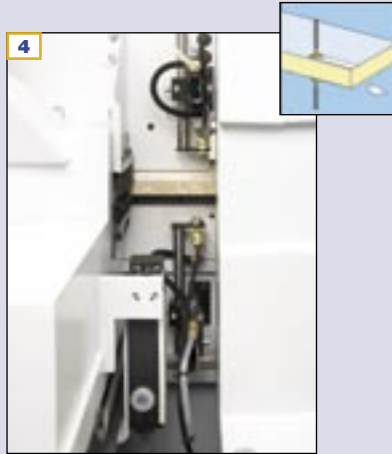

Separating agent spray unit

Prevents hot melt glue residues adhering to the upper and lower surface of the workpiece. Your benefit: no more manual finishing work.

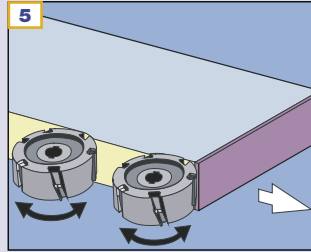

Jointing trimming

For splinter-free trimming of the workpiece edge. Tool diameter 125 mm. For a high standard of processing precision and an above-average tool service life.

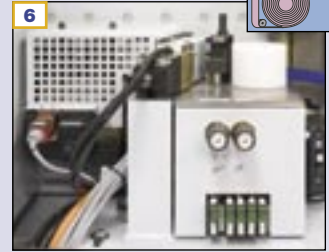

Hot melt gluing unit A3

For optimum glue application on the narrow surface. Changes in workpiece thickness no longer require a change of glue application roller.

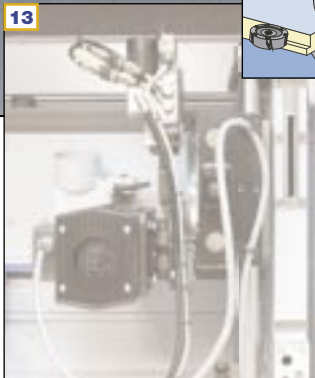
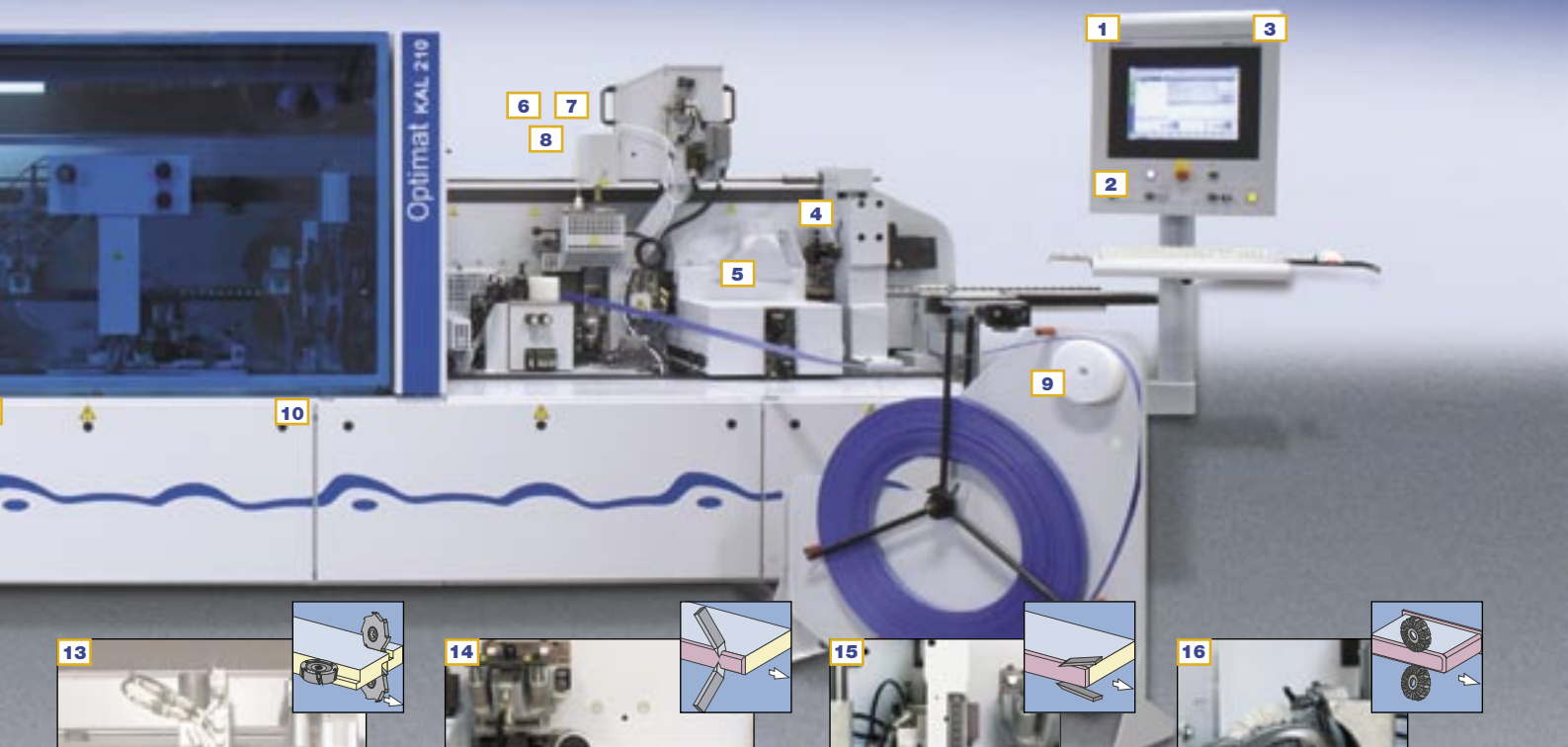

Free space

For equipping the machine with a universal trimming unit UF 11. This can also be retrofitted if required.

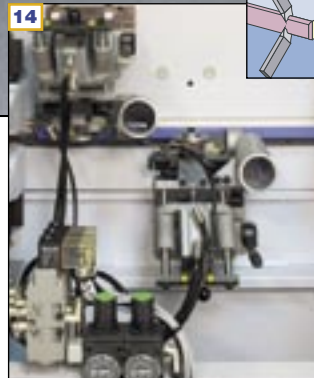

Profile scraper blade PN 10

For smoothing edges on the top and bottom workpiece face. Benefits: better appearance, better edge design, better quality.

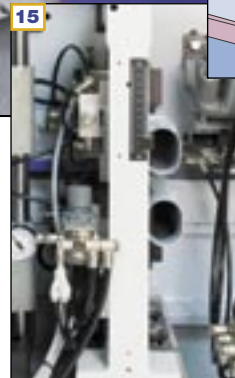

Glue joint scraper blade

For removing hot melt glue residues from the top and bottom face of the workpiece. For optimum finish quality.

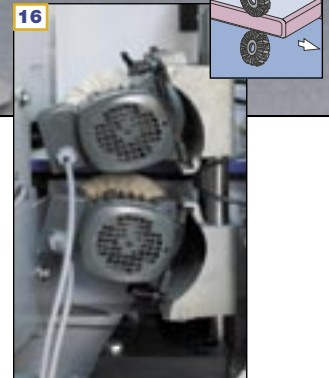

Buffing unit

Imparts a gripping surface to the workpiece and gives ready-to-assemble components their last „polish“ prior to dispatch.

Automation on demand

To enhance the flexibility of your production processes, KAL 210/5/A3/S2 is designed to permit almost seamless automation. The individual components of the automation package are precisely coordinated with the machine, simplifying operating procedures when changing workpiece or edging material thickness, ensuring a consistent high standard of quality, and also reducing set-up times by 50%.

Automatic program-based adjustment of the pressure zone in line with the relevant edging thickness



Electronic program-based height adjustment to the relevant workpiece thickness



Pneumatic horizontal displacement for PN 10/FA 11

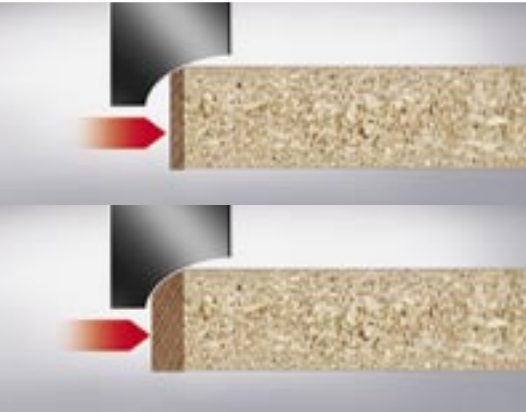

Automatic chamfer/radius adjustment



Trimming unit 0.4 kW (automatic instead of manual) for automatic program-based chamfer/radius adjustment

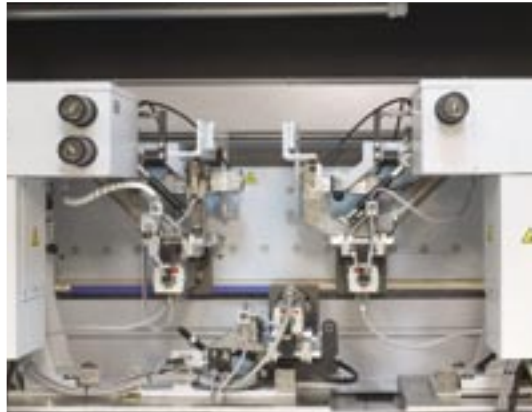

Profile trimming unit FF 12 (automatic instead of manual) for automatic program-based chamfer/radius adjustment

Optional extras

For all those looking for even higher output and more processing scope, we offer a range of innovative extras. These can also be simply retrofitted at a later stage, or adjusted to new or changing requirements. For maximum flexibility and optimum future proof production.

Workpiece thickness WD 60 instead of WD 40, ideal for workpieces such as lightweight panels

I-System diamond radius trimming tool

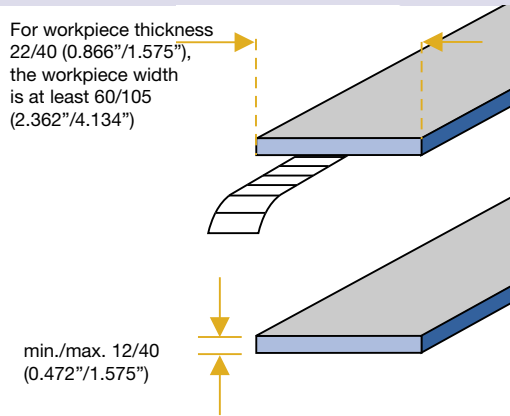

I-System - for controlled capture of chips

New tools with internal extraction facility guide chips directly to the extraction hood. The benefits:

- Optimum processing quality, as the tracing rollers are not impaired by glue or chips
- Substantially greater machine and tool availability
- Greater economy due to minimized extraction input
- Improved workpiece quality

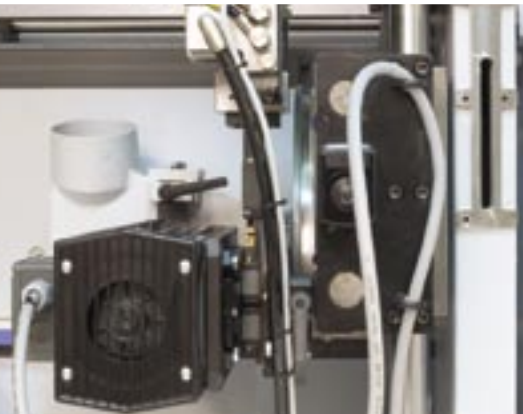

Universal trimming unit UF 11 on free space for grooving, rebate trimming and profiling



Increase of the cooling output for ambient temperatures above 40°C to ensure optimum protection of the electronic system. Ensures reliable, trouble-free production even under extreme climatic conditions



A remote control facility for single-sided machines permits fast set-up

Specifications KAL 210/5/A3/S2

Machine dimensions

- Overall length [mm]	6,880 (270.865")
- Noise protection covers [mm]	
Overall width closed / opened	910/1,540 (35.827"/60.63")
Overall height closed / opened	1,740/2,280 (68.504"/89.764")
Working height [mm]	950 (37.401")

Working dimensions

- Workpiece width [mm]		
With workpiece thickness 22 (0.866") min.	60 (2.362")	
With workpiece thickness 40 (1.575") min.	105 (4.134")	
- Workpiece thickness [mm]	min.	12 (0.472")
	max.	40 (1.575")
	(optionally 60)	(2.362")
- Edge thickness coils [mm]	max.	3.0 (0.118")
- Fixed workpiece overhang [mm]		30 (1.181")

Miscellaneous

- Feed adjustable	18-25 m/min. (82.021 ft.p.m.)
	(optionally up to 32 m/min.) (104.987 ft.p.m.)

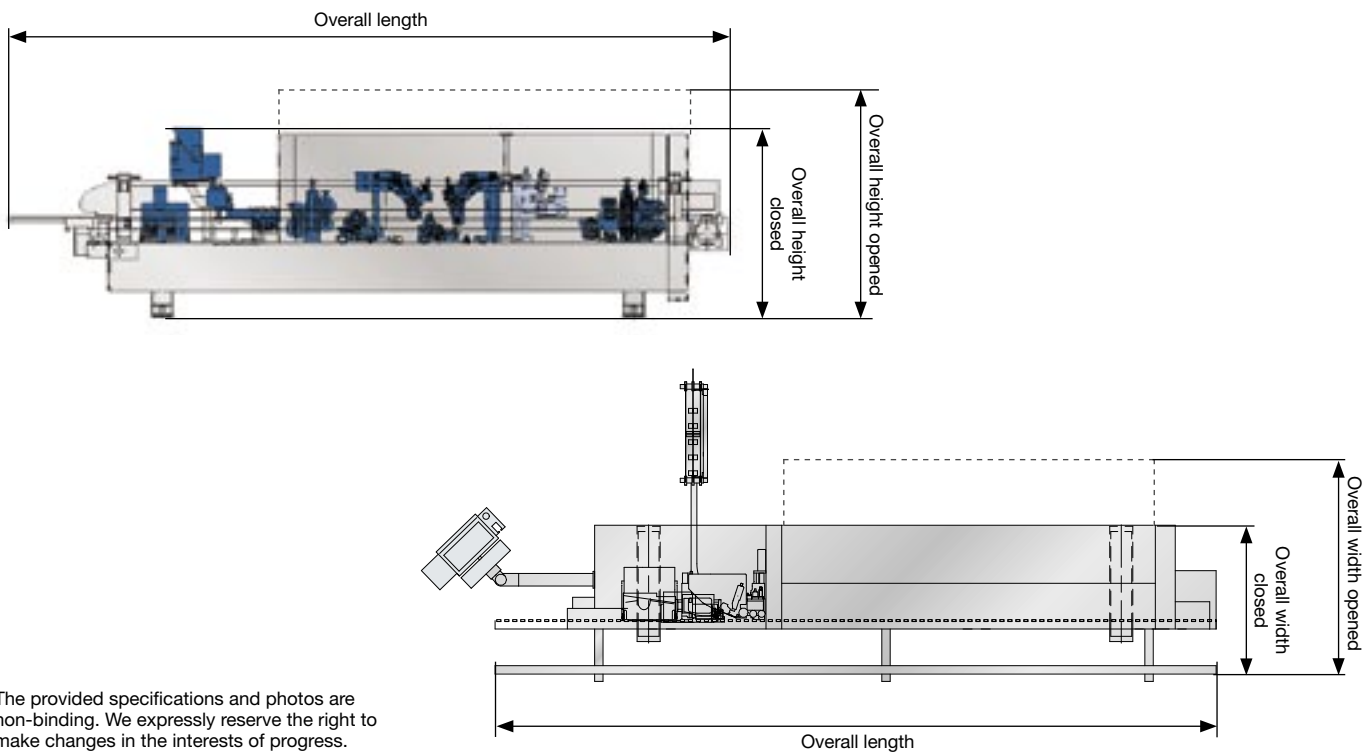

The provided specifications and photos are non-binding. We expressly reserve the right to make changes in the interests of progress.

A member of the HOMAG Group



HOMAG Holzbearbeitungssysteme AG

Homagstraße 3-5
72296 SCHOPFLOCH
GERMANY
Tel.: +49 7443 13-0
Fax: +49 7443 13-2300
E-Mail: info@homag.de
Internet: www.homag.com