

# S1

calibrating sanding machine



When competitiveness  
means reliability and  
durability over time



Made **In** Biesse

## The market demands

the ability to **handle orders** of different sizes and types, with **guaranteed delivery times and high quality standards.**

## Viet responds

with **technology solutions** that can be customised depending on manufacturing requirements and deliver high finished product quality and productivity. **S1** is the calibrating and sanding solution that combines high performance standards with reduced working dimensions, at a very competitive price. Ideal for small and medium-sized businesses, the S1 ensures maximum reliability and precision, derived from the experience gleaned from higher-end machines.

- ✓ **Exceptional finish quality.**
- ✓ **Enormous versatility and flexibility of use on a single machine.**
- ✓ **Superb results guaranteed by cutting-edge technology.**

# Sturdiness and functionality



**S1**  
calibrating sanding machine



# Exceptional finish quality

The robust and stable structure of the S1 ensures precision and reliability.



The **base** has a one-piece frame in welded steel. The generous thickness of the materials used guarantees the stability and durability of the entire structure.



In the mobile head version (optional), the work table is positioned at 900 mm from the ground, thus ensuring ease of panel loading and unloading.

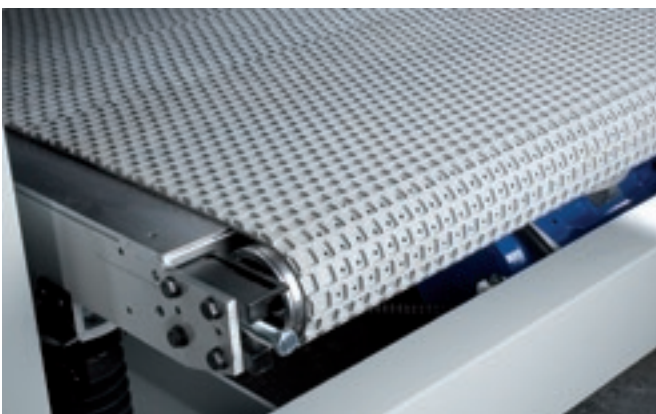

S1 is equipped with a thick, wear-resistant stainless steel work table that guarantees precision and sturdiness during any type of machining operation.



Pad



Roller



Combined

S1 is the calibrating sanding machine that can accommodate up to 2 working units, ensuring high finish quality across all products and superb machining flexibility.

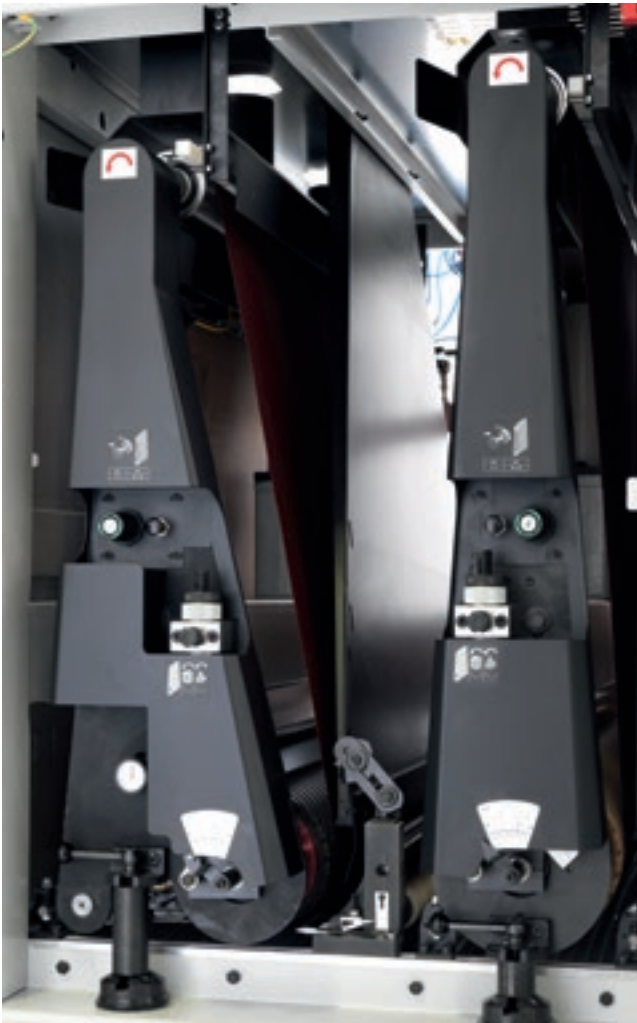

Roller version, combined roller/pad.



Combined version roller/pad, pad.

# Can be customised in accordance with customer requirements



The **Roller unit** is extremely precise and effective. Depending on the hardness of the rubber used and the roller's cross-section, the unit can be used to calibrate, sand or finish.

Available cross-section sizes:



For calibration operations, the machine can be equipped with 190 or 240 mm cross-section steel or 20-90 shore rubber rollers, fitted with 25 Hp motors.



## **Braking system**

Viet uses disc brakes with floating callipers for every engine installed. This motorcycle-derived system guarantees speed and safety.



## **Belt tensioning**

The large tensioning roller allows for perfect belt translations in all working conditions.



# High-technology to enhance machine performance

**The S1 is built using the same technology implemented on higher-range machines. Optimal quality, less waste and significant cost reduction.**

The **sectioned electronic pad** enables users to perform high-quality sanding operations thanks to the electro-pneumatic sectors that are only actioned on the panel's surface. The vast range of possible adjustments offers specific functionalities for different types of processing operations.

The **electronic pad equipped with HP (High Performance) technology** enhances processing results, both as far as surface flatness and finish are concerned.

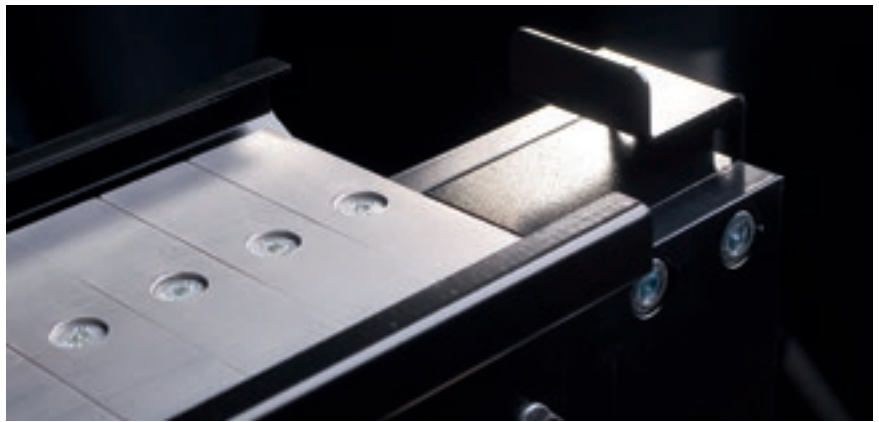

- ✓ +30% greater belt life expectancy.
- ✓ -30% consumption of electricity.
- ✓ Higher finish grade.
- ✓ Even surfaces.
- ✓ -20% dust.
- ✓ No excessive sanding.

#### Save corner.

All electric pads, with IPC controls, are fitted with the exclusive patented Corner Saver function. The system limits the sanding time on the corners of the panel, thus preserving the most delicate portions of the panel's surface.

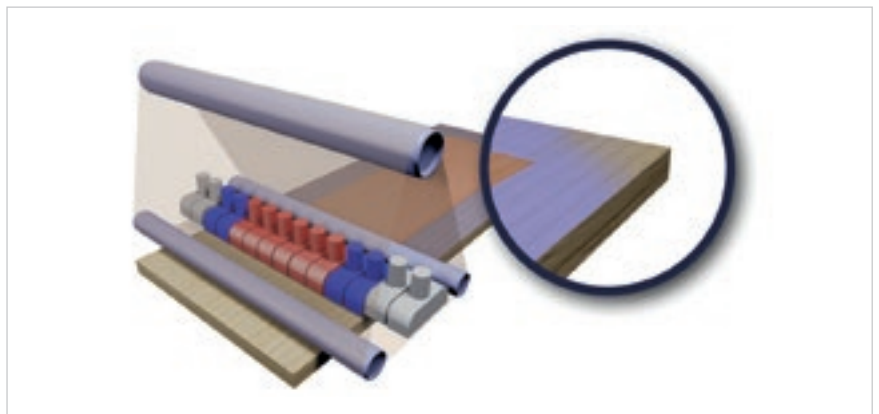
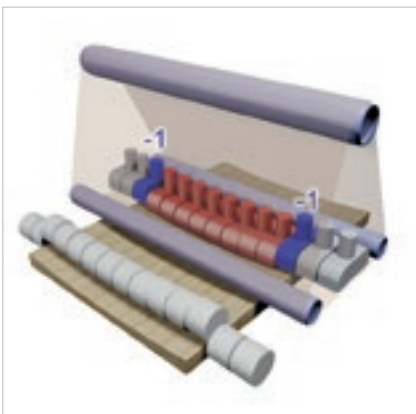

# Superb results guaranteed by cutting-edge technology

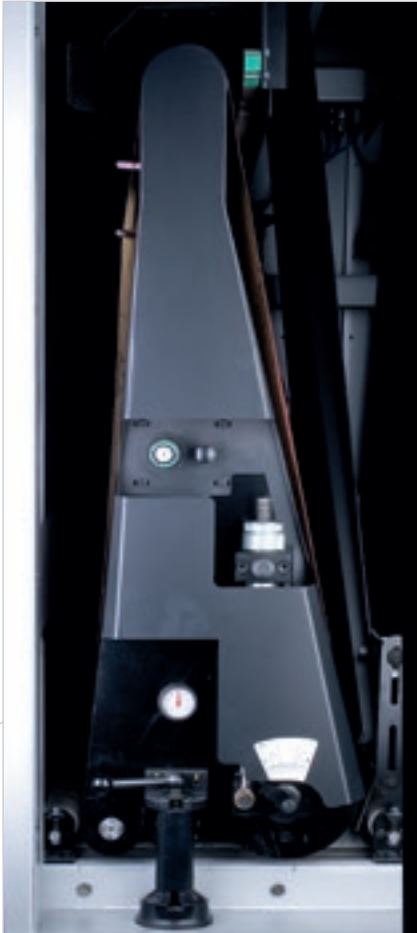

## Combined unit

The Kombi unit, (patented Viet 1967), allows for two tools to remain in contact with the same abrasive belt. Ideal for the operations in which differentiation between types of work is necessary, with no need to add an additional working unit.

Fine surface finishing and polishing for all types of application

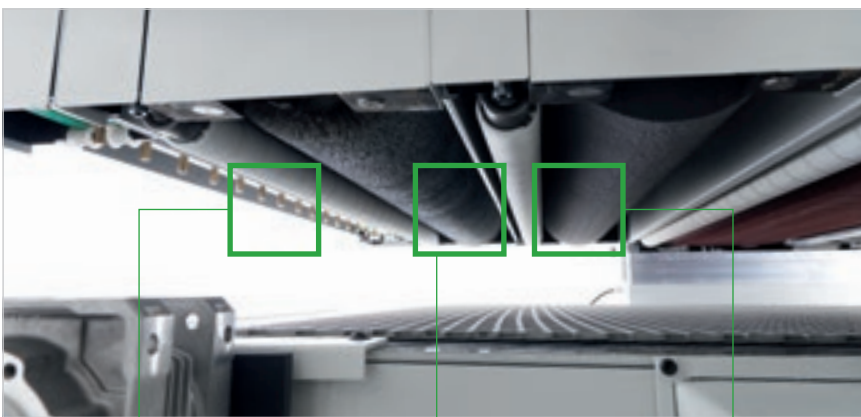

The **linear blower** cleans machining dust from the panel.

The **brushing unit** enables the customer to highlight the wood grain of processed panels.

## Scotch brite

The scotch brite unit is suitable for adding a satin finish to the panels after the smoothing cycle. It provides a uniform finish, using open-pore cycles.



The **brushing unit with abrasive inserts** can be equipped with a transverse oscillation system, to ensure that the finish quality of the product is entirely uniform. Abrasive bristles can be replaced quickly and without the need of removing the unit from the machine.

# Optimal panel cleaning with a great price/performance ratio

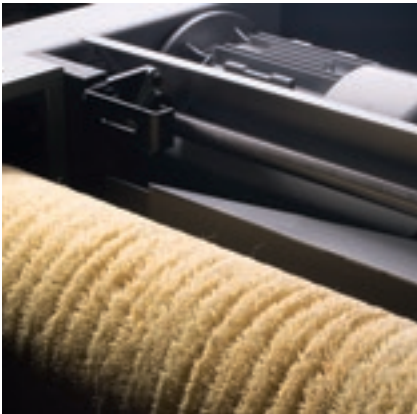

The **panel cleaning brush** can be fitted with bristles of different materials to deep clean the machined panels.



The **anti-static bar** eliminates electrostatic charges on painted panels.



The **rotating blower**, positioned downstream of the machine, enables optimal cleaning of the panel's surface at the end of the sanding cycle.

The **linear blower** is used to finish cleaning the panel's edges. Ideally, it should be coupled with the rotating blower.

# Eco-friendly smoothing



The Energy Saving System is a series of devices designed by Viet to minimise energy consumption during machining. They are engineered and designed to ensure a high degree of efficiency, as well as optimising production, with effective suction thanks to the automatic opening of the collectors, in accordance with the units in operation; in addition, an automatic system stops machines and places them on standby after a pre-determined period of inactivity, and the vacuum table system, which operates by means of an inverter, optimizes the vacuum for holding the panel, according to the size of the panel being processed.



With every attention to saving energy, the Viet range of machines includes the E.S.S. system, which allows for energy savings of up to 30% with regard to both electricity consumption and CO2 emissions. A perfect combination of Biesse technology and Italian genius.

# Service & Parts

Direct, seamless co-ordination of service requests between Service and Parts. Support for Key Customers by dedicated Biesse personnel, either in-house and/or at the customer's site.

## Biesse Service

- ▶ Machine and system installation and commissioning.
- ▶ Training centre dedicated to Biesse Field engineers, subsidiary and dealer personnel; client training directly at client's site.
- ▶ Overhaul, upgrade, repair and maintenance.
- ▶ Remote troubleshooting and diagnostics.
- ▶ Software upgrade.

500 / Biesse Field engineers in Italy and worldwide.

50 / Biesse engineers manning a Teleservice Centre.

550 / certified Dealer engineers.

120 / training courses in a variety of languages every year.

The Biesse Group promotes, nurtures and develops close and constructive relationships with customers in order to better understand their needs and improve its products and after-sales service through two dedicated areas: Biesse Service and Biesse Parts.

With its global network and highly specialised team, it offers technical service and machine/component spares anywhere in the world on-site and 24/7 on-line.

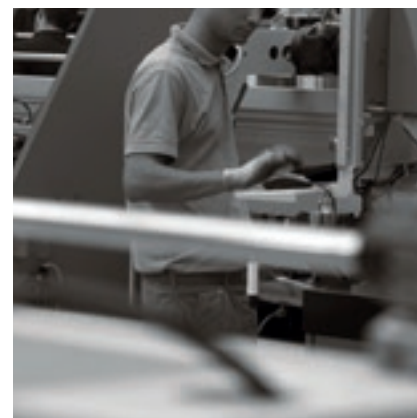

## Biesse Parts

- ▶ Original Biesse spares and spare kits customised for different machine models.
- ▶ Spare part identification support.
- ▶ Offices of DHL, UPS and GLS logistics partners located within the Biesse spare part warehouse, with multiple daily pick-ups.
- ▶ Order fulfilment time optimised thanks to a global distribution network with de-localised, automated warehouses.

92%  of downtime machine orders fulfilled within 24 hours.

96%  of orders delivered in full on time.

100  spare part staff in Italy and worldwide.

500  orders processed every day.

# Ease of use and power

IPC is a range of **control systems** (optional) that are integrated into the machine via 8" or 15" Touch Screen monitors. This control system supports the management of all machine parameters, providing the operator with timely and intuitive information. The industrial PC processor provides control and feedback information to the machine in real time, making it extremely user-friendly for the operator.

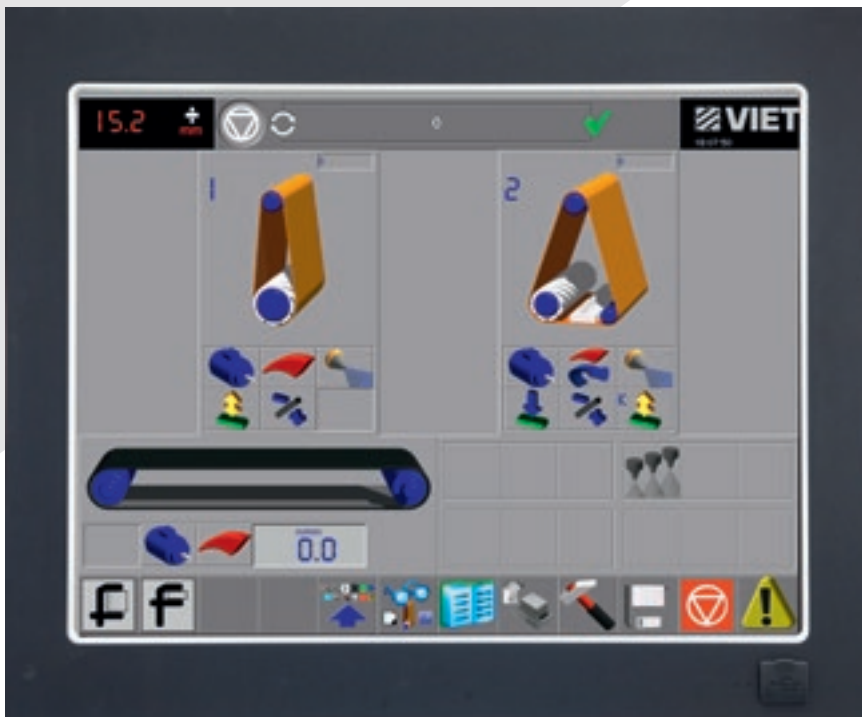

The IPC system is the highest expression of sanding machine management technology available on the market.



Sectioned pad management.



Alarm checks.



Belt wear.



# Technical specifications

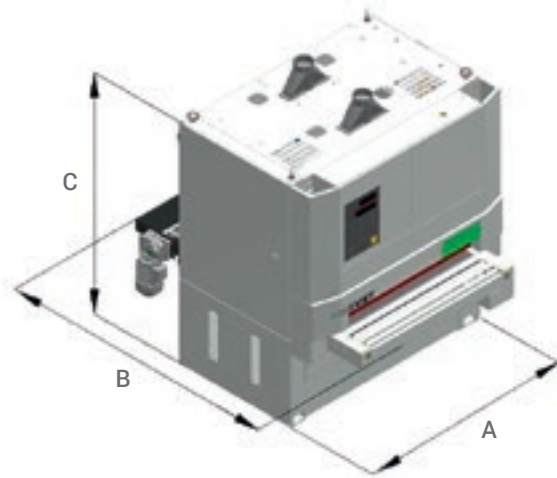

		S1 (1100)	S1 (1350)
A	mm	1760	2010
B	mm	2235	2235
C max (2200 production)	mm	2235	2235
C max (2620 production)	mm	2445	2445
Maximum operating width	mm	1100	1350
Min-max processing thickness	mm	3 - 160	3 - 160
Dimensions of sanding belts (2200 production)	mm	1130 x 2200	1380 x 2200
Dimensions of sanding belts (2620 production)	mm	1130 x 2620	1380 x 2620
Advance speed	m/min	3 - 16	3 - 16
Operating pressure	bar	6	6
Weight	Kg	2350	2690
Motor power of up to	kW	18.5	18.5

The technical specifications and drawings are non-binding. Some photos may show machines equipped with optional features. Biesse Spa reserves the right to carry out modifications without prior notice.

Weighted sound pressure levels at the machine entry operator station: 75.0 dB(A) without load, 76.0 dB(A) with load. Weighted sound pressure levels at the machine exit operator station: 70.5 dB(A) without load, 71.0 dB(A) with load.

Viet Srl. designed the machine to reduce airborne noise emission at source to the lowest possible level, in accordance with the requirements of Community Directive 2006/42/EC, and commissioned a test to determine the sound pressure emission level at the operator station for the smoothing/sanding machine. Standards: The measurement was carried out in compliance with UNI EN ISO 19085-8:2018, UNI EN ISO 11202:2010. The noise levels shown are emission levels and do not necessarily correspond to safe operation levels. Even though there is a relation between emission levels and exposure levels, this cannot be used reliably to establish whether further precautions are necessary. The factors determining the noise levels to which the operative personnel are exposed include the length of exposure, the characteristics of the work area, as well as other sources of dust and noise, etc. (i.e. the number of machines and processes concurrently operating in the vicinity). In any case, the information supplied will help the user of the machine to better assess the danger and risks involved.

# Made **With** Biesse

**Craftsmanship and cutting-edge technology to make the sweet music of success.**

Over 80,000 instruments installed in over 80 countries for Allen Organ, the largest organ manufacturer in the world. Headquartered in Macungie, PA, in the USA, and founded by Jerome Markowitz in 1937, Allen Organ boasts 200 employees and manufacturing facilities with a surface of 225,000 m<sup>2</sup>. "Allen" states Dan Hummel, Manufacturing Director, "has a high degree of vertical integration, which requires the company to have the utmost quality control and the flexibility to make changes in relatively quick time scales, depending on customer needs. We have some very

peculiar requirements as far as production and planning of creative solutions are concerned. Our customers demand both customised products and classic organs that are standard stock items. However, even standard organs are often modified to respond to specific needs". Allen organs are built by combining veneered panels with solid wood. "Everybody works very closely with suppliers to guarantee the best quality solid woods and panels", adds Hummel. The raw material is processed using high-tech machinery during the various production phases, to get to the end

product. During the last step, the processed wood is sanded using a Biesse finishing centre. The touch-screen operated sanding centre has a combined roller/roller and sectioned pad unit for the sanding of veneered panels and solid wood.

*Source: Custom Woodworking Business Jan. 2013 Woodworking Network/Vance Publications.*

*Allen Organ is the leader in the manufacturing of superior-quality digital organs and similar instruments. Quality, craftsmanship and cutting-edge technology.*



<http://www.allenorgan.com>



# Biesse Group

In / 1 industrial group, 4 divisions  
and 12 production sites.

How / € 14 million p/a in R&D  
and 200 patents registered.

Where / 39 branches and 300  
agents/selected dealers.

With / Customers in 120 countries (manufacturers of furniture,  
design items and door/window frames, producers of ele-  
ments for the building, nautical and aerospace industries).

We / 4,200 employees throughout the world.

**Biesse Group** is a multinational leader in the technology for processing wood, glass, stone, plastic and metal.

Founded in Pesaro in 1969, by Giancarlo Selci, the company has been listed on the STAR sector of Borsa Italiana since June 2001 and is currently a constituent of the FTSE IT Mid Cap index.

 **BIESSEGROUP**

 **BIESSE**

 **INTERMAC**

 **DIAMUT**

**MECHATRONICS**

