

MORR



Numerically controlled
machining centres

Author 632 · 636 · 644 · 655 · 667



MORBIDELLI

Looking for these results...

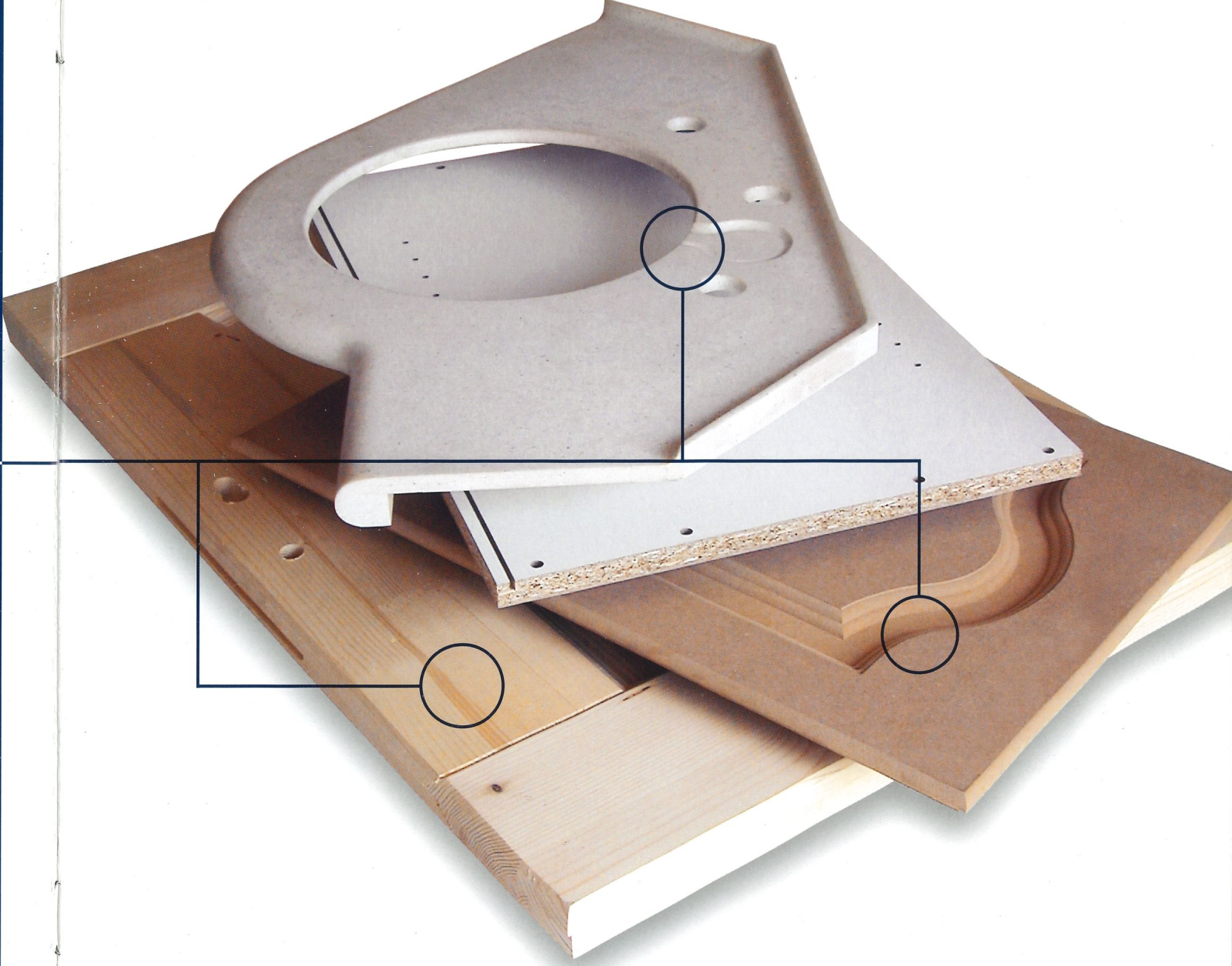

...these are superior performances
for quality and speed

- **Maximum speed** tool change with the **Rapid** system, the only one able to substitute cutters while the machine is performing other operations.
- **Great versatility** thanks to tool change devices which allow **up to 29 tools on board the machine**.
- **Increased productivity**, with axis movement speeds up to 80 m/min.
- Up to **6 independent units** for rapidly changing the type of machining.
- **Flexible panel hold-downs**, with a variety of solutions for the worktables available.
- **A quality finish and unprecedented reliability** thanks to the strong base and use of cutting edge design and construction technologies.
- **Unbelievably simple use and programming** of the innovative numeric control based on a Windows operating system.

Author

632·636·644·655·667



If you want superior balance and strength...

The structure is designed to guarantee maximum strength and to balance dynamic loads, giving high precision machining, both for boring and routing.

The self-supporting steel base with a triangular cross-section is a **solid and balanced support** for the machine's moving parts. The strengthening ribs and the large supporting base are designed and built to guarantee lasting machine stability and precision, under any working conditions.

The mobile machining unit consists of a **single-piece unit with one beam**. Its parts are **electric arc-welded**, for maximum **torsional rigidity year after year**.

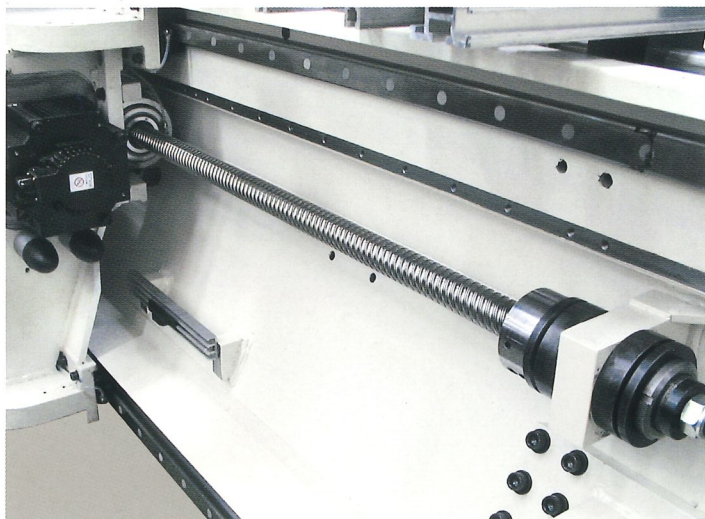
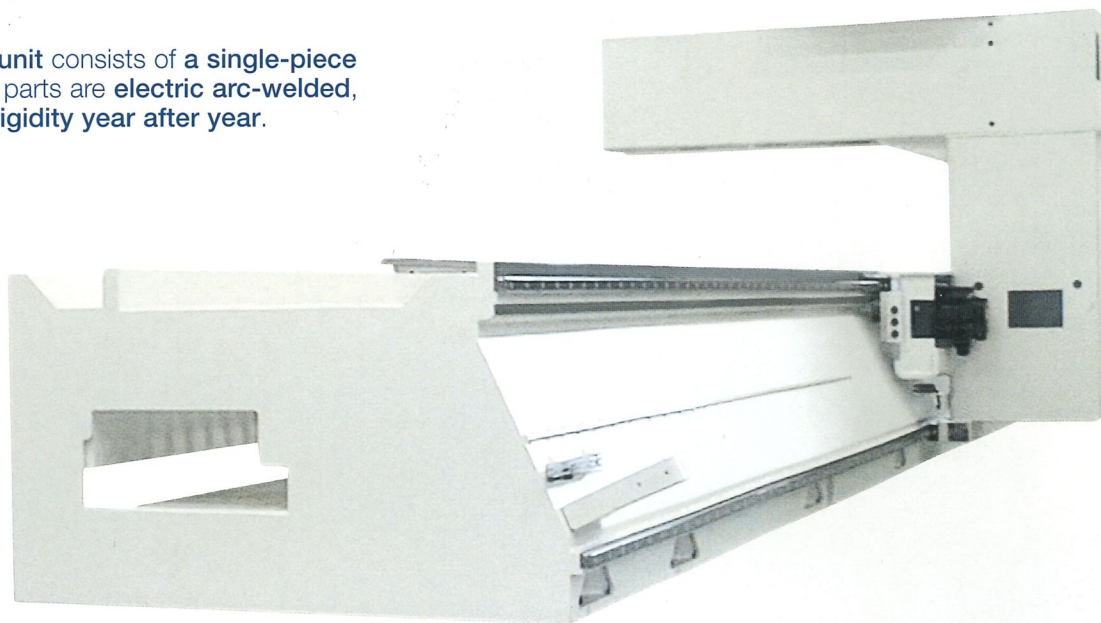

X, Y and Z axis movements are driven by Brushless motors on recirculating ball screws, allowing **acceleration and deceleration of up to 5 m/sec²** with absolute positioning precision. The axes movement does not require a particular maintenance, this because it can be lubricated automatically without any operator intervention.*

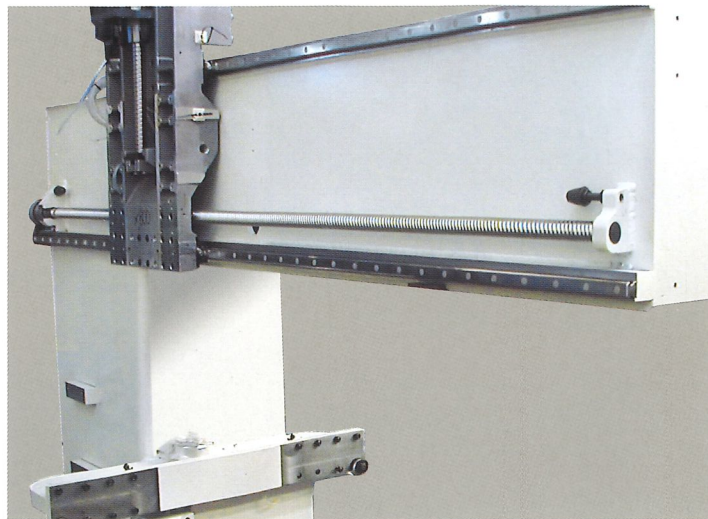

The mobile units run on **ground prism guides**, offset relative to their vertical axis to allow equal balancing of loads during machining.

"Made to measure" boring for all your customers' requirements...



All of the boring units on Morbidelli machining centres are made with the new (patented) integral bearings and can reach speeds of rotation of up to 6000 rpm.

This solution provides:

- Higher Z-axis feed speed
- Reduced machining time on panels
- Improved hole quality
- There are no problems with shavings extraction. The extractor system is built into the structure of the head and removes sawdust at the point closest to where it is produced. The result is an improved workpiece finishing.

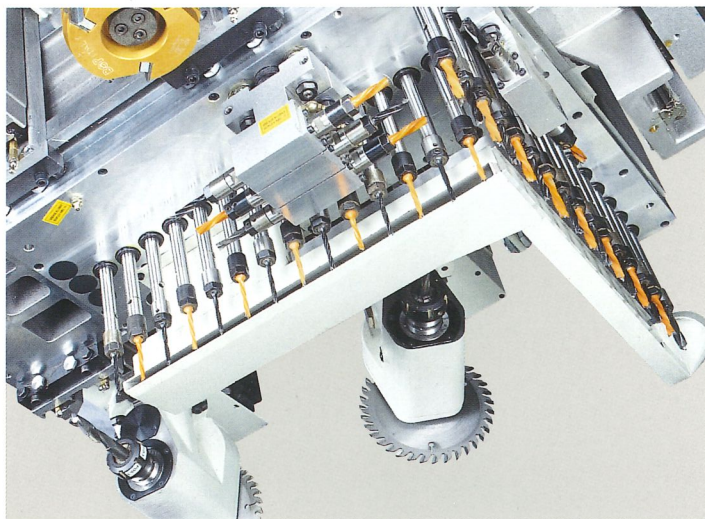

For high productivity boring, such as **the sides of wardrobes and similar items**, there is a boring unit with 30 vertical spindles and an additional head with 11 spindles and numerically controlled Y-axis movements.

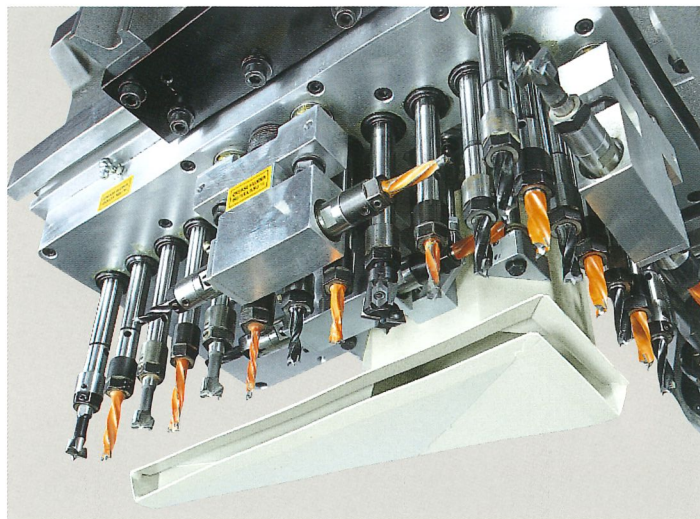

Possibility of selecting boring units with 10, 12 or 18 independent vertical spindles and up to 6 horizontal spindles for boring on the 5 faces of a panel.

For greater flexibility while using an ever increasing number of tools...

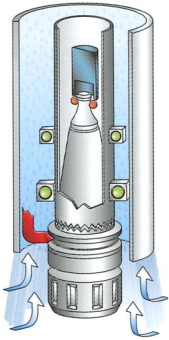

The **electro-spindle** delivers constant power from 9000 to 18000 rpm per minute and guarantees precision machining and lasting reliability thanks to its single-piece structure with internal pressurisation designed to prevent sawdust infiltration. The speed of the **Rapid** tool changer, which can pass from one profile to another while the machine carries out other work, means that the machining centre can be configured for any requirements, from contractors to door manufacturers, from kitchens to wardrobes and even office furniture. Specific configurations and customised compositions can always be created by combining tool change solutions designed to cater for specific requirements for both **panel producers with a highly varied mix** and those producing **small batches of identical panels**.

Solution with machine fitted with two 6.6 kW routing units and a Rapid 6 tool changer system. **You can change the tool on one motor at any time while the second continues machining.**

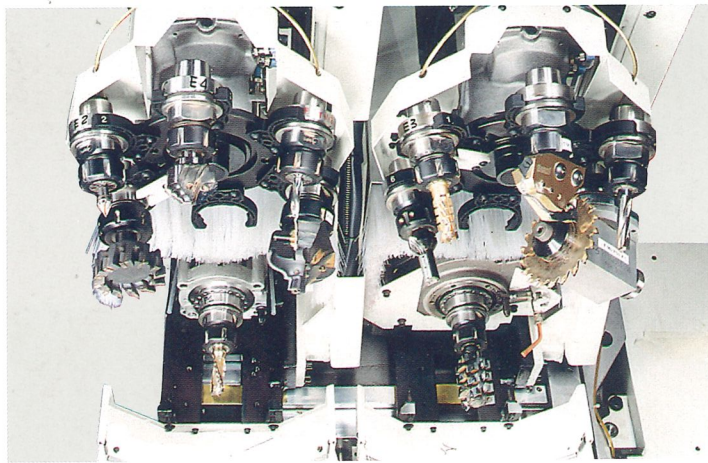

When using a **very large number of tools** the Tool Room with 12 tools, which can be swapped with those in the Rapid magazine, **avoids continuous manual magazine retooling, so that the tools used on the individual workpieces are always available.**

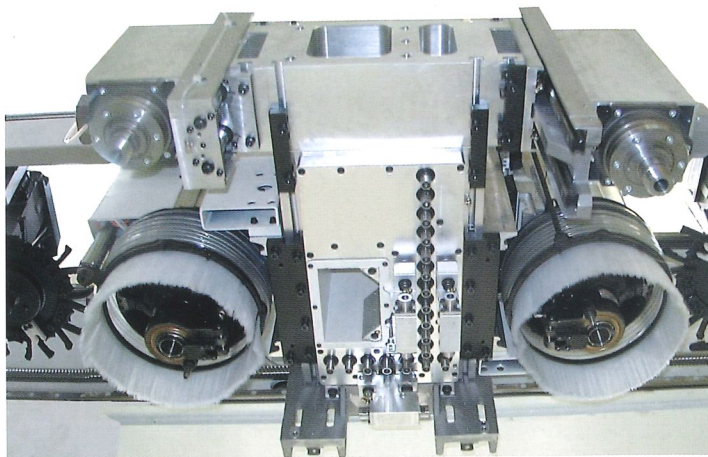
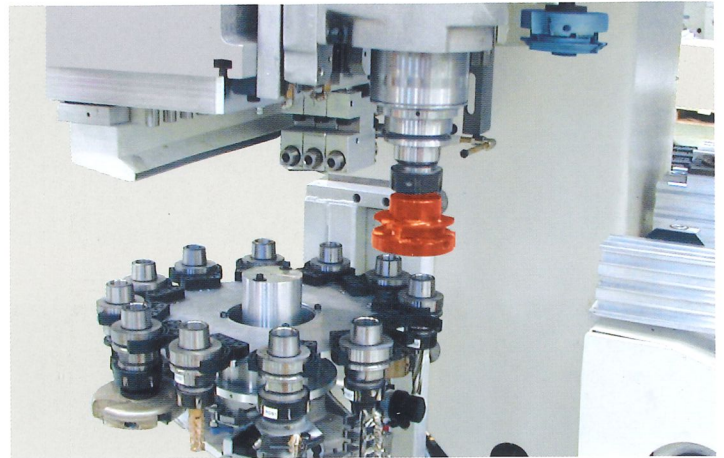

This configuration allows **the same routing simultaneously on two panels**, doubling the machine's production capacity.

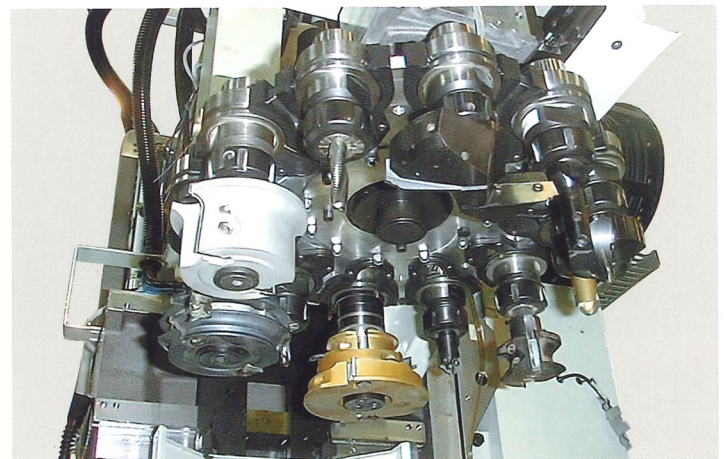

Use of the Rapid 10 or 14 system, with 7.5 and 11 kW routing units, **significantly reduces machine down times and increases productivity**, with a positive effect on production costs for individual workpieces.

If you want power and reliability for precision in the most complex machining...

The machine's **highly flexible configuration** allows you to select dedicated independent units for different machining operations. These units are recommended **for heavy duty and continuous machining**, which subject machining units to high levels of stress. The solution using specific units for given work is the only one **that offers units with maximum power and reliability.**

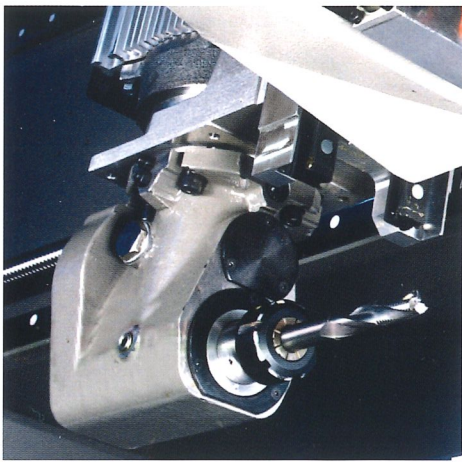

Horizontal unit for a router or blade. Available both in a fixed position and with numerically controlled 0-360° automatic rotation. **Ideal for lock recesses for doors, front doors and retractable table supports.**

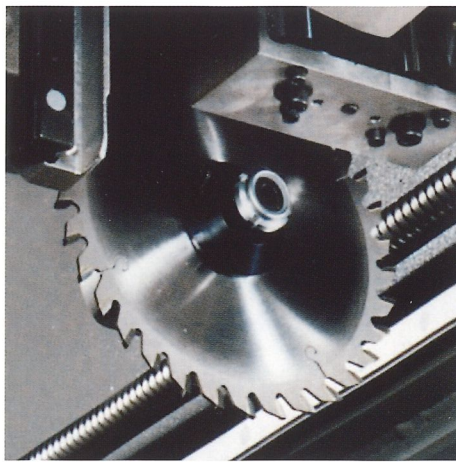

Routing unit with fixed disc or numerically controlled 0-90° and 0-360° automatic rotation for blades with 160/200 mm diameter. **Recommended for end trimming and squaring workpieces made of any material.**

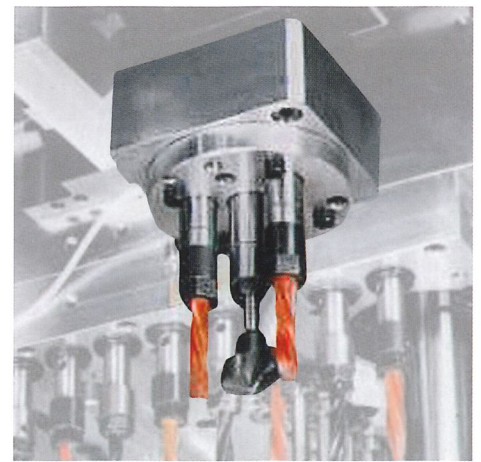

Boring unit for the housing of hinges **on sides, shelves, bottoms and similar parts.**

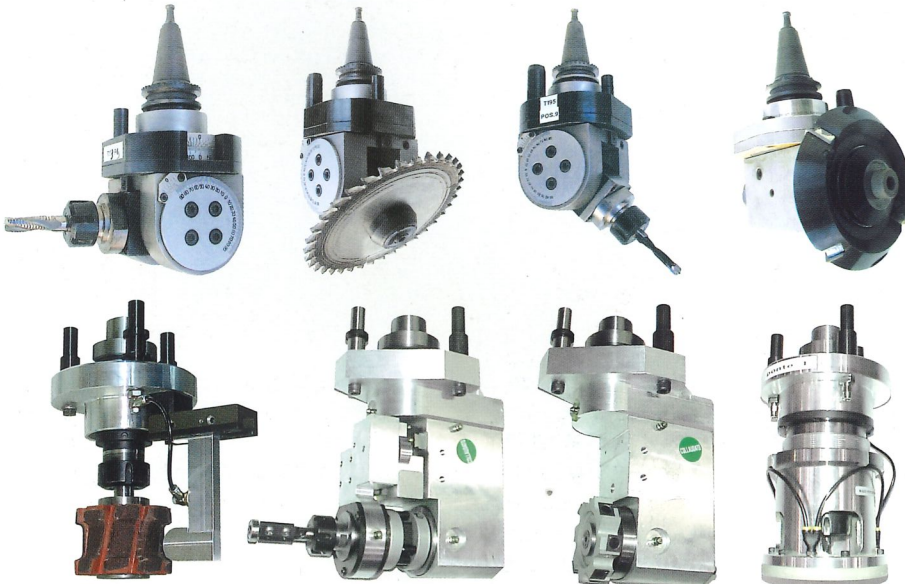

For light workings and not continuous machining it is possible to use different types of angular heads that can be managed by any kind of tool changing system.

If you're looking for fast and flexible worktable settings...

All different panel hold-down requirements are satisfied with the worktable options in the Morbidelli range:

Worktable with multi-function suction cups

These suction cups can operate both at the worktable level and 25 mm above it, in both cases allowing tilting along the Z-axis so as to hold down even panels that aren't completely flat. Passing from the lowered position to the raised position is fast and easy thanks to an ergonomically located device.

Quick Set Up worktable

This type of table has aluminium supports without any tubes and pneumatic connections, which could obstruct suction cup positioning. The suction cups, of different sizes and heights, can be released from the individual supports and can be managed relative to the panel dimensions so as to concentrate the vacuum only where it's needed, increasing work piece hold-down efficiency.

Dedicated systems, available with a high capacity compressed air system, for holding down special work pieces such as frames, uprights, etc.

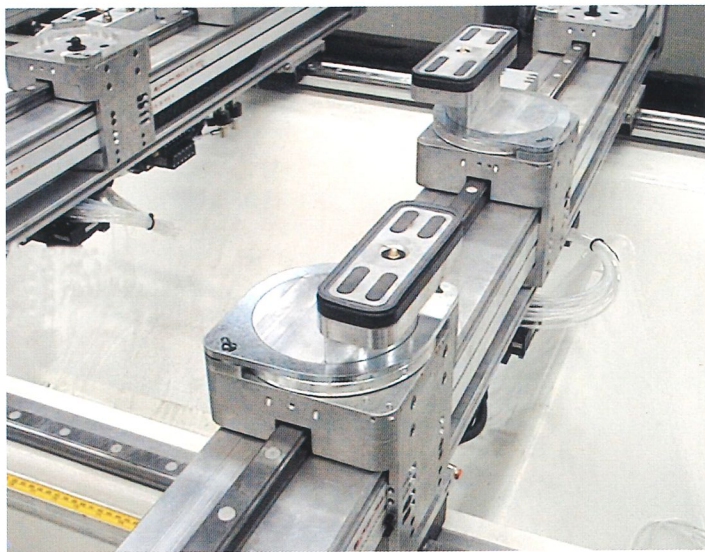
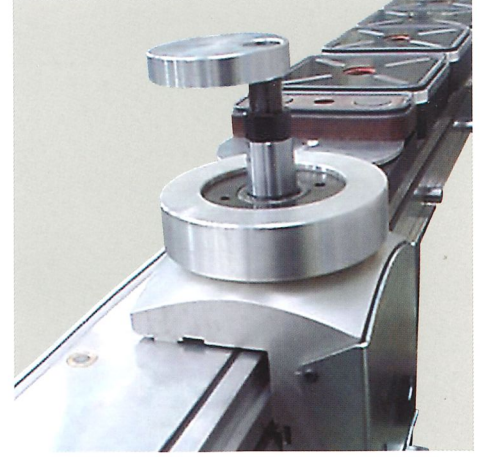

FAT (Full Automatic Table), a table with completely automated supports and suction cups, which can move into position for the specific machining, required within seconds.

FET (Fast Electronic Table), a solution, which allows you to set up half a machine worktable while machining, is being performed on the other side. Therefore, the times for this operation are masked by the machining cycle, which is never interrupted.

Author 632 · 636 · 644 · 655 · 667

Nesting Based Manufacturing

Advantages

- Reduction of the rejected materials.
- Drastic lowering of the “Time to Market” due to the possibility to work on a single work order.
- Production of single pieces considerably shorter.
- Increase of quality of the finished product because of the less manipulation of pieces and thanks to the use of only a single machine.
- Reduction of the stock of work in progress parts; you produce only what it is sold.
- An almost completely automated solution and, so, with reduction of labour use.
- Reduction of machinery, which intervenes in the production run with consequent reduction of investments in equipment and of the impact of, fixed costs.

The aluminium working table with vacuum locking allows a “nesting” processing and the production of all the pieces for a specific manufacture article (kitchen, wardrobe, desk or other) by optimising the use of one or more material papers as MDF, chipboard, multiplayer and so on.

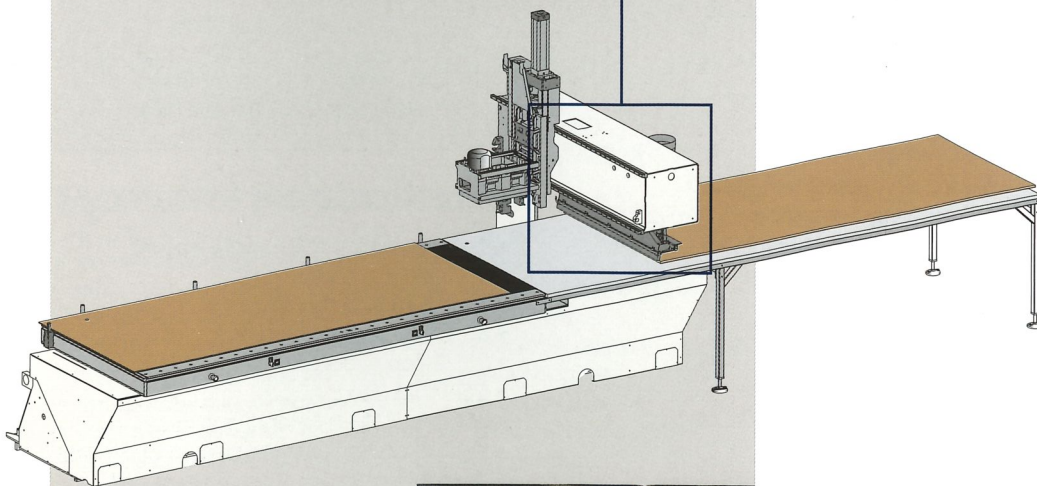
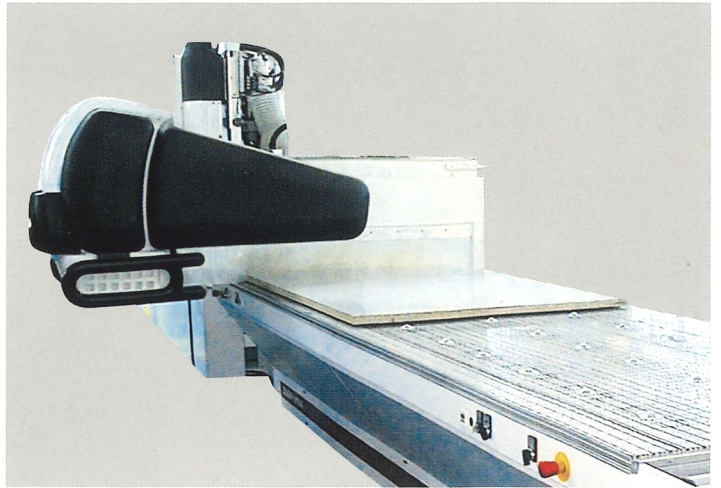
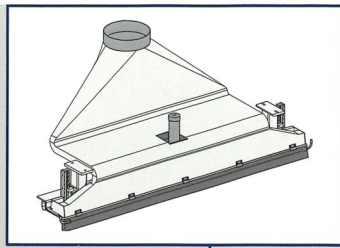

The side pusher is designed for an easy and automatic handling of finished pieces out of the machine. This device is directly mounted on mobile beam and it pushes the finished pieces on a support surface on the right end of the machine. It also cleans and clears the working area for next processing, thanks to a suction device. The operator can arrange the finished pieces without losing time, while the machine continues its working schedule.

If you want a simple and immediately programmable numeric control...

Morbidelli machining centres are equipped with an innovative numeric control, with a Personal Computer as operator interface.



This solution guarantees the operator an **incomparable level of user-friendliness** and **comfort, making work much easier.**

Morbidelli software operates in a **Windows environment** for **simple, effective programming.**

The software design takes into account programmer requirements, to cater for both expert operators and machining centre first time users.

The **graphical aids** allow intuitive programming, without extensive computer skills. Yet even those with more confidence will find something familiar in it, not requiring extra effort to take in new systems and will immediately be able to appreciate its great potential.



Remote control device to manage the main functions of the machine.

Main hardware features

- Intel processor (2.0 GHz or above);
- 15" colour monitor;
- Keyboard and mouse;
- 80 Gb (or above) hard disk;
- 3"1/2 floppy disk drive (1,44 Mb);
- CD ROM (48x);
- 256 Mb RAM memory (or above);
- 2 serial ports, 1 parallel port, 4 USB ports (to connect to any type of peripheral: bar code reader, modem, printer, scanner etc...);
- Network card (opt.), sound card.

Author 632 · 636 · 644 · 655 · 667

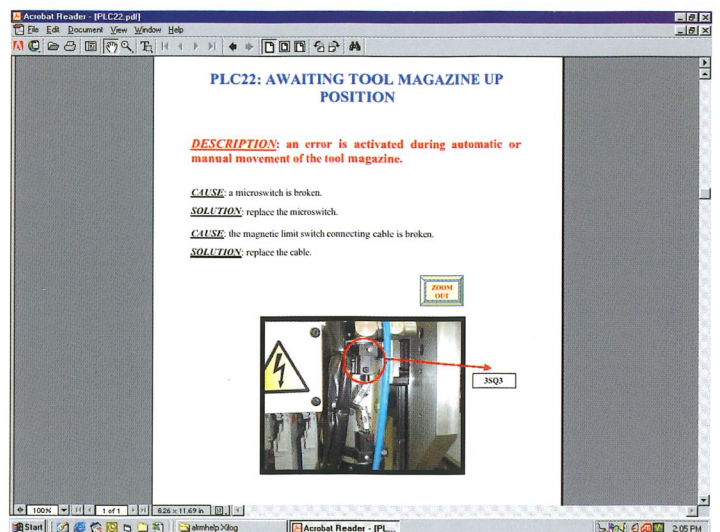
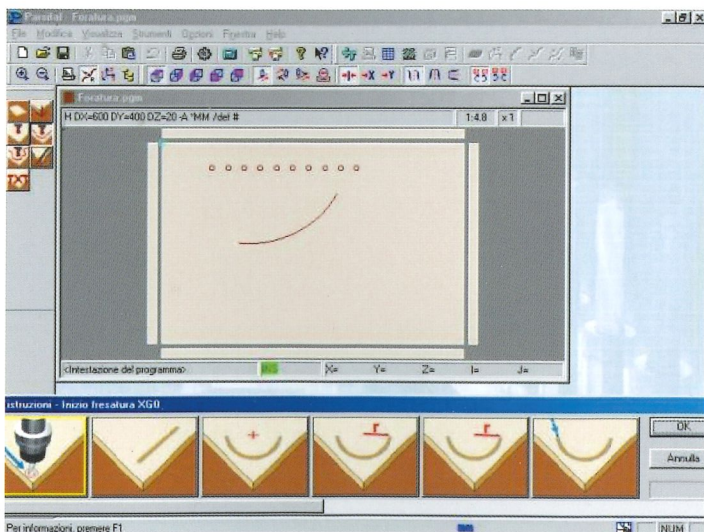
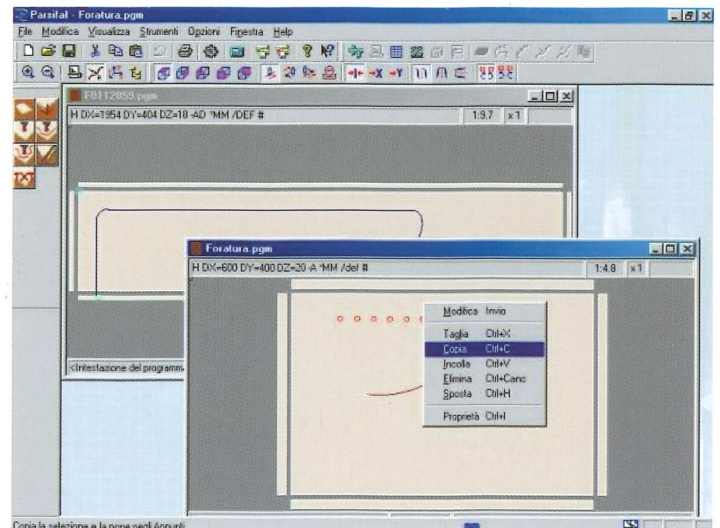
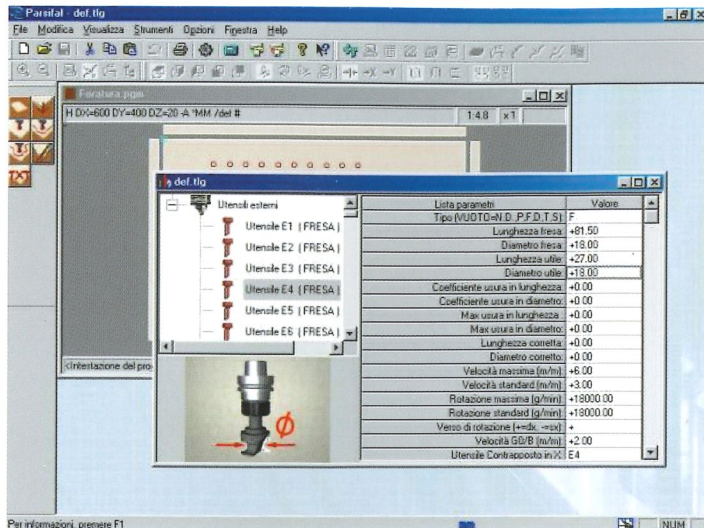

Main software features

- Windows operating system with functions such as: copy, paste, edit, clear, properties, curtain menu, right click on the mouse for quick menu, multiple opening of windows etc.
- Equipping management with **tool visualisation** and with graphic supports to avoid the possibility of data input errors;
- **Immediate and direct uploads** of DXF format files;
- **Optimised dynamic drilling; graphic and syntactic aids** or drilling and milling operations to speed up data input operations;
- **Graphic visualisation of the manufactured piece** to allow for a quick and efficient check of the programme results;
- **Parametric programming**, to automatically update the programme when the sizes of the manufactured piece change, thus avoiding having to write a new programme;
- **Macro creation in a few minutes**, by using parametric;
- **Creation of programme blocks** that can be inserted inside other programmes;
- **Self diagnosis and warning of any errors** or possible failures through alarm messages in the user's language that aid quick understanding;
- **Graphic aids for the positioning of work supports** to avoid collisions with the tools in cases of passing drilling and/or milling to eliminate the empirical trials directly on the machine;
- **Execution of programmes through bar codes.**

If you believe in an innovative and practical CE safety system...

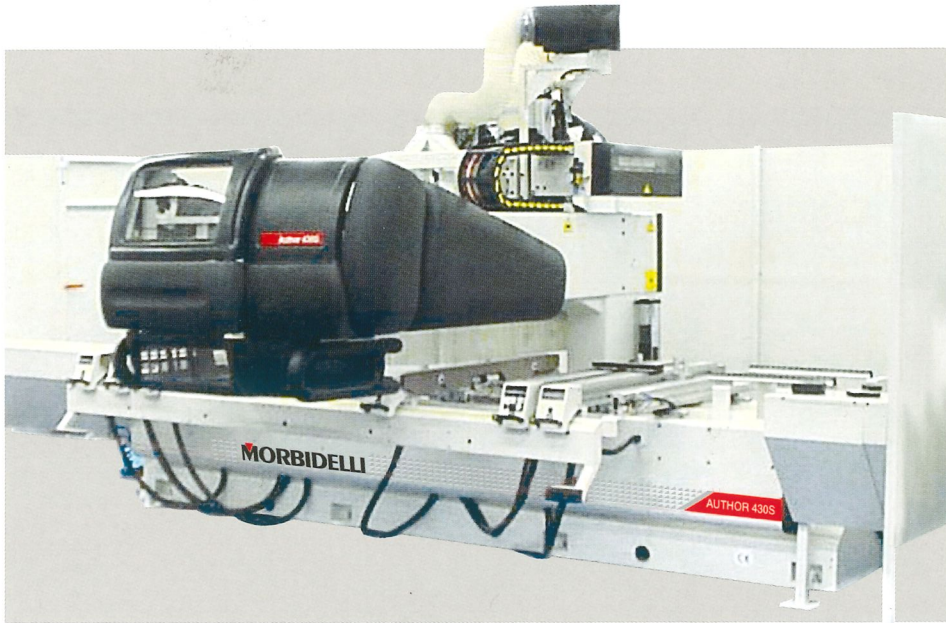

Bumpers

This system has bumpers fitted around the mobile upright, with sensors which immediately stop the machine if there is any contact with obstacles. **Operator safety is always safeguarded**, since any contact is dampened by the absorbent material used to make the bumpers and by the machine stopping immediately within just a few centimetres.

The advantages of this system are:

- machine use at its maximum production capacity, without unwanted interruptions in the production cycle;
- possibility of **pendulum machining on larger panels**, with the same X-axis machining range, compared with the solution with mats.

Safety mats

This solution has three sensitive mats at the front of the machine. The mats are fitted with sensors, which stop the machining cycle when the operator enters the machine operating range. This so-called "active" safety system **prevents any contact** between the machine moving parts and the operator.

Overall dimensions

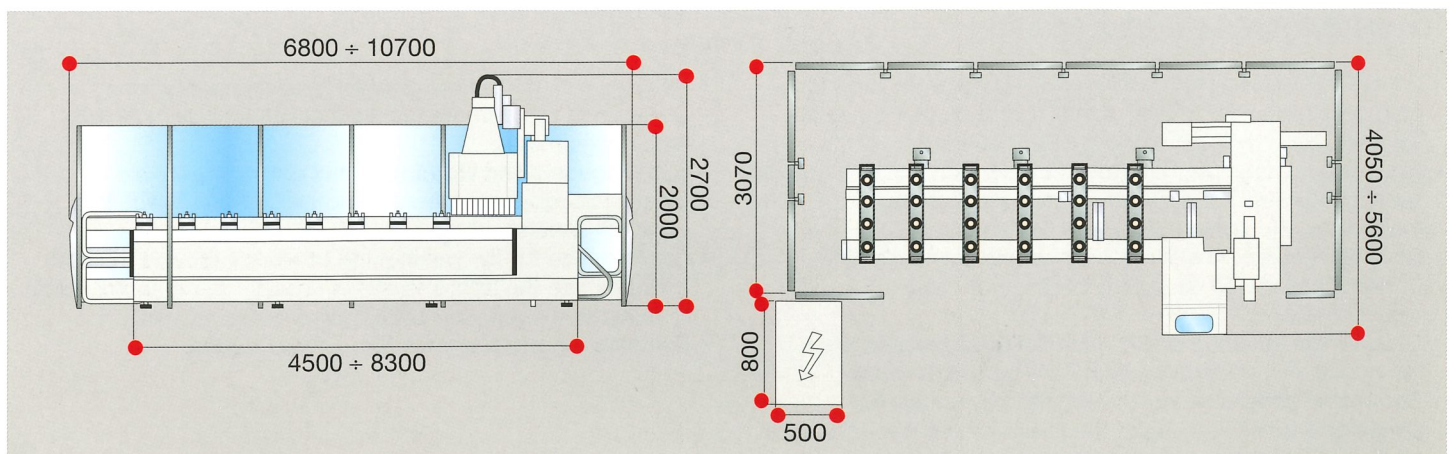

In this catalogue, machines are shown with options. The firm reserves the right to modify technical specifications without prior notice, provided that such modifications do not affect safety as per E.C. certification.

Technical data



Speed movement X axis	m/m	40/50/80
Speed movement Y axis	m/m	45/80
Speed movement Z axis	m/m	22,5
Electro-spindle power	KW	6,6/7,5/11,0
Disc saw unit power	KW	1,2
Max Diameter saw blade	mm	200
Speed drilling bits	rpm	4500/6000
N. vertical spindles		12/18/30/41
N. horizontal spindles		6/8/10/14/16
Tools available on tool-room		4/12

Tools available on rapid		6/8/10/12/14
Work area in Y axis – drilling	mm	1120 (1230)
Work area in Y axis – routing	mm	1360 (1470)
Panel passage	mm	180
Y axis stroke	mm	1480 (1590)
Z axis stroke	mm	200 (280)
Intake air consumption	m³/h	5400 ÷ 7500
Centralised extractor outlet diameter	mm	250/300
Installed power	KW	20 ÷ 30
Weight	Kg	3600 ÷ 6000

Working area

	Author 632	Author 636	Author 644	Author 655	Author 667
X (mm)	3870	4255	4940	6170	7380
X1 (mm)	3200	3660	4400	5500	6700
X2 (mm)	1530	1760	2130	2680	3280

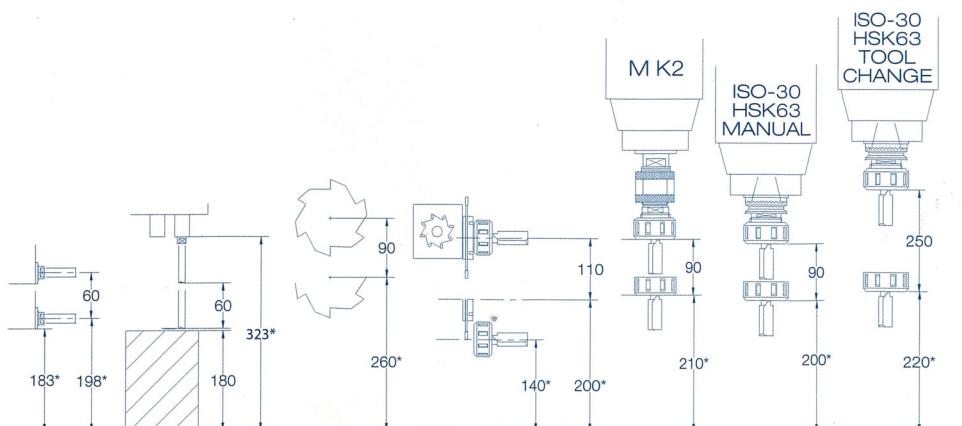
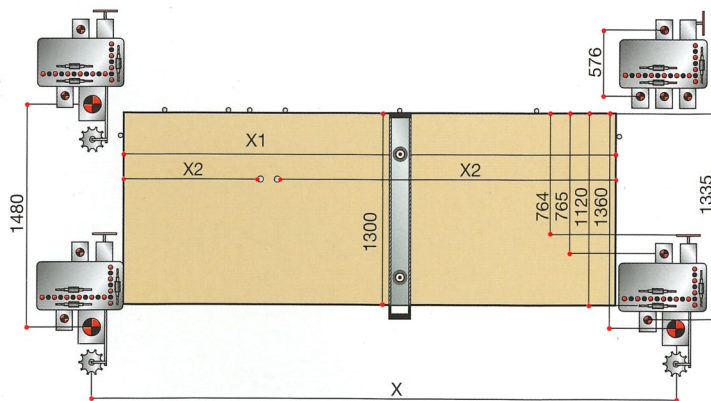

Tools stroke

* With Turn & Work vacuum cups and axis Z stroke=200 mm

SINCERT



MORBIDELLI

MORBIDELLI

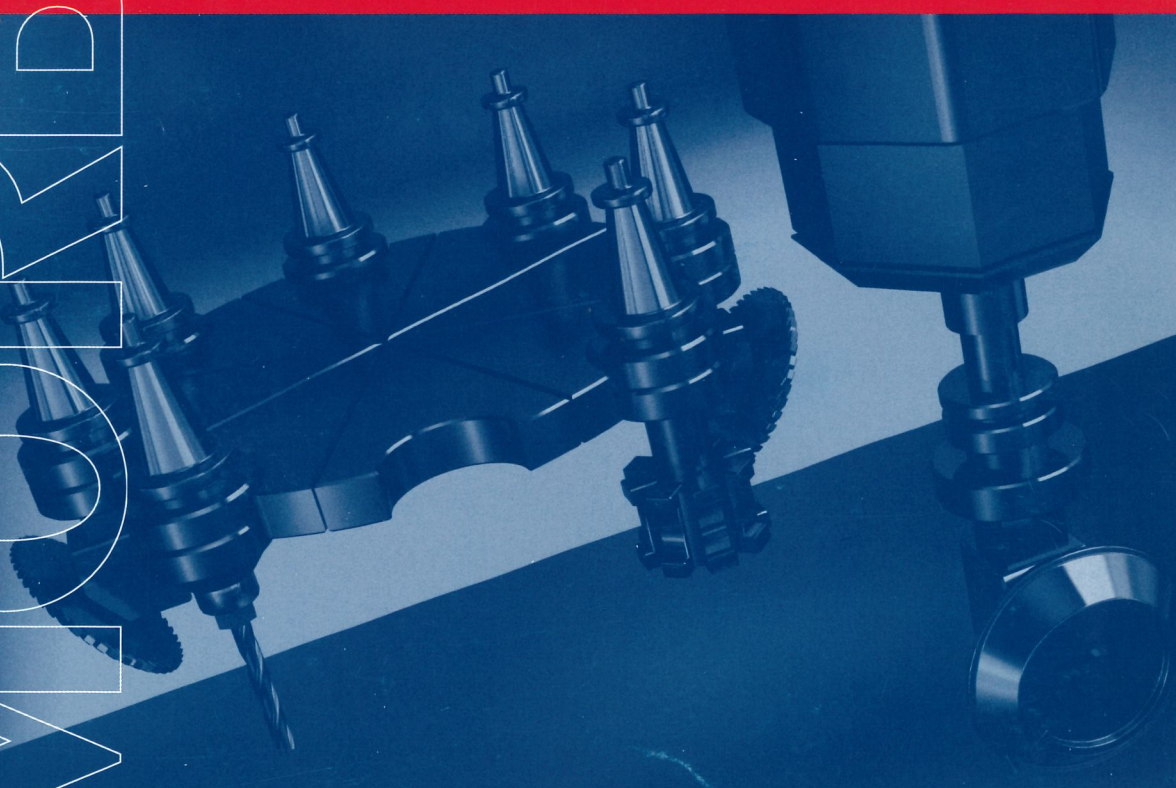

MORBIDELLI

SCM GROUP spa - MORBIDELLI - Strada Montefeltro, 81/3 - 61100 Pesaro - Italia
Tel. +39/0721/4451 - Fax +39/0721/445264 - www.scmgroup.com - E-mail: morbidelli@scmgroup.com